

ROTOR

POWERED BY SRAM™



(english) **technical manual**
part # GEN.0000000002607

SRAM LLC WARRANTY

SRAM warrants its products to be free from defects in materials or workmanship for a period of two years after original purchase. This warranty only applies to the original owner and is not transferable. Claims under this warranty must be made through the retailer where the bicycle or the SRAM component was purchased. Original proof of purchase is required.

This warranty statement gives the customer specific legal rights. The customer may also have other rights which vary from state to state (USA), from province to province (Canada), and from country to country elsewhere in the world.

To the extent that this warranty statement is inconsistent with the local law, this warranty shall be deemed modified to be consistent with such law, under such local law, certain disclaimers and limitations of this warranty statement may apply to the customer. For example, some states in the United States of America, as well as some governments outside of the United States (including provinces in Canada) may:

- a. Preclude the disclaimers and limitations of this warranty statement from limiting the statutory rights of the consumer (e.g. United Kingdom).
- b. Otherwise restrict the ability of a manufacturer to enforce such disclaimers or limitations.

To the extent allowed by local law, except for the obligations specifically set forth in this warranty statement, in no event shall SRAM or its third-party suppliers be liable for direct, indirect, special, incidental, or consequential damages.

· This warranty does not apply to products that have been incorrectly installed and/or adjusted according to the respective SRAM technical installation manual. The SRAM installation manuals can be found online at www.sram.com, www.rockshox.com or www.avidbike.com.

· This warranty does not apply when the product has been modified.

· This warranty does not apply when the serial number or production code has been deliberately altered, defaced or removed.

· This warranty does not apply to damage to the product caused by a crash, impact, abuse of the product, non-compliance with manufacturer's specifications of usage or any other circumstances in which the product has been subjected to forces or loads beyond its design.

· This warranty does not apply to normal wear and tear. Wear and tear parts are subject to damage as a result of normal use, failure to service according to SRAM recommendations and/or riding or installation in conditions or applications other than recommended.

Wear and tear parts are identified as:

Dust seals/Bushings/Air sealing o-rings/Glide rings/Rubber moving parts/Foam rings/Rear shock mounting hardware and main seals/Stripped threads and bolts (aluminum,titanium, magnesium or steel)/Upper tubes (stanchions)/Brake sleeves/Brake pads/Chains/Sprockets/Cassettes/Shifter and brake cables (inner and outer)/Handlebar grips/Shifter grips/Jockey wheels/Disc brake rotors/Wheel braking surfaces/Bottom out pads/Bearings/Bearing Races/Pawls/Transmission gears/Tools

· This warranty shall not cover damages caused by the use of parts of different manufacturers.

· This warranty shall not cover damages caused by the use of parts that are not compatible, suitable and/or authorized by SRAM for use with SRAM components.

· This warranty shall not cover damages resulting from commercial (rental) use.

ROCKSHOX SUSPENSION SERVICE

We recommend that you have your RockShox suspension serviced by a qualified bicycle mechanic. Servicing RockShox suspension requires knowledge of suspension components as well as the special tools and fluids used for service.

Used suspension fluid should be recycled or disposed of in accordance to local and federal regulations.

NEVER pour suspension fluid down a sewage or drainage system or into the ground or a body of water.

This publication includes trademarks and registered trademarks of SRAM Corporation designated by the symbols ™ and ®, respectively.

Copyright © SRAM LLC 2009

For exploded diagram and part number information, please refer to the Spare Parts Catalog available on our web site at www.sram.com.

For order information, please contact your local SRAM distributor or dealer.

Information contained in this publication is subject to change at any time without prior notice. For the latest technical information, please visit our website at www.sram.com.

Your product's appearance may differ from the pictures/diagrams contained in this catalog.

Product names used in this document may be trademarks or registered trademarks of others.

TABLE OF CONTENTS

FRONT SUSPENSION SERVICE - GETTING STARTED	5
FRONT SUSPENSION TECHNOLOGY AND OIL VOLUMES (ALL FORKS)	6
FRONT SUSPENSION TOOLS NEEDED FOR SERVICE (ALL FORKS).....	9
FRONT SUSPENSION TORQUE TIGHTENING VALUES (ALL FORKS).....	11
BUSHING INSPECTION, LOWER LEG REMOVAL, AND SEAL SERVICE	12
LOWER LEG BUSHING INSPECTION	13
LOWER LEG REMOVAL (ALL FORKS)	14
LOWER LEG SEAL SERVICE (ALL FORKS).....	15
DAMPER SERVICE	18
REBOUND & TURNKEY DAMPER SERVICE (ARGYLE 302 - DART 2, 3 - DOMAIN 302 - LYRIK R - PIKE 327 - RECON 327, 335, XC, SL - TORA 289, 302, XC, SL)	19
MOTION CONTROL DAMPER SERVICE (ARGYLE 318, 409 - DOMAIN 318 - LYRIK IS - TORA 318 - TOTEM IS).....	22
MOTION CONTROL/BLACKBOX MOTION CONTROL DAMPER SERVICE (PIKE 409, 426, 454 - REBA SL, RACE, TEAM - RECON 351, RACE - REVELATION SL, RACE, TEAM - SID RACE, TEAM, WC)	25
REMOTE SERVICE (PUSHLOC - POPLOC ADJUST - POPLOC)	29
MISSION CONTROL DAMPER SERVICE (LYRIK - TOTEM).....	31
SPRING SERVICE	34
COIL SPRING SERVICE (ARGYLE 302, 318 - DART 1, 2, 2 (WITH TURNKEY), 3 - DOMAIN 302, 318 - TORA 289, 302, 318)	35
COIL SPRING SERVICE (TORA XC, SL, RECON XC, SL, RACE).....	36
COIL SPRING SERVICE (TOTEM - LYRIK).....	37
COIL U-TURN SPRING SERVICE (DOMAIN 302, 318 - TORA 289, 302, 318).....	38
COIL U-TURN SPRING SERVICE (LYRIK - PIKE 327, 351, 409, 426, 454 - RECON 327, 335, 351)	39
SOLO AIR SPRING SERVICE (ARGYLE 409 - TORA XC, SL, 318).....	40
SOLO AIR SPRING SERVICE (RECON 327, 335, 351).....	43
SOLO AIR SPRING SERVICE (RECON XC, SL).....	46
SOLO AIR SPRING SERVICE (LYRIK IS, R - TOTEM).....	49
DUAL AIR SPRING SERVICE (PIKE 409, 426, 454 - REBA SL, RACE, TEAM - REVELATION SL, RACE, TEAM - SID RACE, TEAM, WC)	52
AIR U-TURN SPRING SERVICE (PIKE 409, 429, 454 - REBA RACE, TEAM - REVELATION SL, RACE, TEAM).....	55
2-STEP AIR SPRING SERVICE (LYRIK - TOTEM).....	60
LOWER LEG INSTALLATION	66
LOWER LEG INSTALLATION (ALL FORKS)	67
BOXXER WORLD CUP	69
BOXXER TEAM	90
BOXXER RACE	108
REAR SHOCK SERVICE - GETTING STARTED	125
TOOLS NEEDED FOR SERVICE (ALL REAR SHOCKS)	126
REAR SHOCK SERVICE (BAR)	127
MOUNTING HARDWARE & BUSHING SERVICE (ARIO - MONARCH - VIVID).....	130
REAR SHOCK SERVICE (MONARCH/ARIO).....	133
REAR SHOCK SERVICE (VIVID).....	140



SAFETY FIRST!

At SRAM, we care about YOU. Please, always wear your safety glasses and protective gloves when servicing your RockShox suspension. Protect yourself! Wear your safety gear!

FRONT SUSPENSION SERVICE - GETTING STARTED

KEY

The RockShox Technical Manual separates front suspension into five main service categories:

1. Lower leg removal
2. Lower leg bushing and seal service
3. Damper service
4. Spring service
5. Lower leg installation

The service of front suspension dampers and springs is further sub-categorized based on the technology of the damper and spring, rather than by the name of the fork. Therefore, it is imperative for you determine the technology used in your front suspension. If you are unsure of the technology used in your front suspension, contact your local RockShox dealer for assistance.

FRONT SUSPENSION TECHNOLOGY AND OIL VOLUMES (ALL FORKS)

The following chart is a complete list of the 2010 RockShox front suspension line-up. It details the front suspension model, corresponding damper and spring technology, along with the oil volume and Pit-Stop oil weight required for each upper tube and lower leg.

		Damper technology (drive side)	Volume (mL)	Oil wt	Volume (mL)	Oil wt	Spring technology (non-drive side)	Volume (mL)	Oil wt	Volume (mL)	Oil wt				
			Upper tube		Lower leg			Upper tube		Lower leg					
Argyle	302	rebound only					coil								
	318	Motion Control	130	5	10	15	coil	-	-	30	15				
	409						Solo Air	6	15	15					
Dart	1	none	-	-	-	-	coil	-	-	-	-				
	2	rebound only	150	5	-	-									
	2 (w/Turnkey) (80-100 mm)	Turnkey	93		10	15									
	2 (w/Turnkey) (120 mm)	Turnkey	109		10	15									
	3, 29r (80-100 mm)	Turnkey	93		10	15									
	3 (120 mm)	Turnkey	109		10	15									
Domain	302	rebound only	200		5	10	15	coil	-	-	15	15			
	318	Motion Control		Coil U-Turn				coil					Coil U-Turn		
Lyrik	R	rebound only	213	5	15	15	coil	-	-	15	15				
	Coil U-Turn	Motion Control IS	187				Solo Air	6	15						
	Solo Air						U-Turn	-	-						
	2-Step						Solo Air	6	15						
	Coil U-Turn	Mission Control	193				2-Step	35	2.5	10					
	IS Solo Air						U-Turn	-	-	15					
	IS 2-Step						Solo Air	6	15	15					
	2-Step			35	2.5	10									
Pike	327	rebound only	140	5	15	15	Coil U-Turn	-	-	15	15				
	351	Motion Control					Coil U-Turn								
	409						Air U-Turn					6	15		
	426						Dual Air					-	-	15	
							Coil U-Turn								
	454						Air U-Turn					6	15		
							Dual Air					-	-	15	
							Coil U-Turn								
							Air U-Turn								6
	Dual Air						6								15

FRONT SUSPENSION TECHNOLOGY AND OIL VOLUMES (CONTINUED)

		Damper technology (drive side)	Volume (ml)	Oil wt	Volume (ml)	Oil wt	Spring technology (non-drive side)	Volume (ml)	Oil wt	Volume (ml)	Oil wt				
			Upper tube		Lower leg			Upper tube		Lower leg					
Reba	SL, Race	Motion Control	123	5	5	15	Air U-Turn	grease	grease	5	15				
	Team	Blackbox Motion Control	123				Dual Air								
Recon	XC	rebound only	115	5	6	15	coil					-	-	10	15
	SL	Turnkey	115	5	6	15	Solo Air					3	5	6	
	Race	Motion Control	123	5	6	15	coil	-	-	10					
	327 (standard axle)	rebound	120	5	5	15	Solo Air	3	5	6					
	327 (thru axle)	rebound	128				coil	-	-	10					
	335 (standard axle)	Turnkey	120	5	5	15	Solo Air	3	5	6					
	335 (thru axle)	Turnkey	128				coil	-	-	10					
	351 (standard axle)	Motion Control	130	5	5	15	Solo Air	3	5	6					
	351 (thru axle)	Motion Control	138				Coil U-Turn	-	-	15					
	Revelation	SL, Race	Motion Control	123	5	5	15	Air U-Turn	grease	grease	5	15			
		Team	Blackbox Motion Control	133				Dual Air							
		Race	Motion Control	94	Air U-Turn										
		Team, World Cup	Blackbox Motion Control	96	Dual Air										

FRONT SUSPENSION TECHNOLOGY AND OIL VOLUMES (CONTINUED)

		Damper technology (drive side)	Volume (ml)	Oil wt	Volume (ml)	Oil wt	Spring technology (non-drive side)	Volume (ml)	Oil wt	Volume (ml)	Oil wt
			Upper tube		Lower leg			Upper tube		Lower leg	
Totem	coil	Mission Control	203	5	20	15	coil	-	-	20	15
	Solo Air						6	15			
	2-Step						135	2.5			
	IS coil	Motion Control IS	193				coil	-	-		
Tora	XC	rebound only	147	5	6	15	coil	-	-	10	15
	SL	Turnkey	147	5	6	15	Solo Air	3	5	6	
	289	rebound only	150	5	15	15	coil	-	-	10	
	302	Turnkey					Solo Air	3	5	6	
	318	Motion Control					coil	-	-	20	
							Coil U-Turn	-	-	30	
							coil	-	-	20	
							Coil U-Turn	-	-	30	
			Solo Air	3	5	15					
			coil	-	-	20					
			Coil U-Turn	-	-	20					
			Solo Air	6	15	15					
			130				Solo Air	6	15	15	

FRONT SUSPENSION TOOLS NEEDED FOR SERVICE (ALL FORKS)

The following chart is a list of the model year 2010 tools needed for service on your RockShox front suspension. While this chart is intended to be comprehensive, it is still only a guide. The tools required for each step of service are detailed in the text of each service section. Keep in mind your specific fork may not require every tool listed.

TOOLS	LOWER LEG REMOVAL	SEAL SERVICE	DAMPER SERVICE	SPRING SERVICE	LOWER LEG INSTALLATION
SAFETY/STARTING EQUIPMENT					
SAFETY GLASSES	X	X	X	X	X
APRON	X	X	X	X	X
RUBBER GLOVES	X	X	X	X	X
CLEAN RAGS (LINT FREE)	X	X	X	X	X
OIL PAN	X	X	X	X	X
CLEAN WORK AREA	X	X	X	X	X
BICYCLE STAND	X		X	X	X
BENCH VISE		X			
WRENCHES/PLIERS					
1.5 mm HEX			X		
2 mm HEX				X	
2.5 mm HEX			X	X	X
5 mm HEX	X				X
6 mm HEX				X	
8 mm HEX				X	
10 mm SOCKET OR OPEN ENDED WRENCH	X				X
14 mm SOCKET				X	
15 mm SOCKET				X	
24 mm SOCKET			X	X	
SOCKET EXTENSION	X			X	X
24 mm FLAT WRENCH OR Mission Control WRENCH			X		
TORQUE WRENCH			X	X	
SLIP JOINT PLIERS			X		
SNAP RING PLIERS - INTERNAL			X	X	
SNAP RING PLIERS - EXTERNAL			X	X	
MISC TOOLS					
PLASTIC Mallet	X	X	X	X	X
LONG DOWEL ROD (PLASTIC OR WOOD)*	X	X	X	X	X
FLATHEAD SCREWDRIVER		X		X	
32 mm, 35 mm, OR 40 mm SEAL INSTALLER					
SHARP PICK			X	X	
SHOCK PUMP				X	X
SCHRADER VALVE CORE TOOL				X	
MAGNET				X	
RULER					X

* using a non-metallic dowel rod helps to ensure the inside of upper tubes or lower legs do not get scratched

FRONT SUSPENSION TOOLS NEEDED FOR SERVICE (CONTINUED)

TOOLS	LOWER LEG REMOVAL	BUSHING & SEAL SERVICE	DAMPER SERVICE	SPRING SERVICE	LOWER LEG INSTALLATION
OIL/LIQUIDS					
2.5, 5, 10 OR 15wt PIT-STOP SUSPENSION OIL		X	X	X	X
GREASE (SUSPENSION OIL SOLUBLE)		X	X	X	X
i-RIDE GREASE (MAXIMA SG-920)				X	
CLEAN RAGS (LINT FREE)	X	X	X	X	X
OIL MEASURING DEVICE		X	X	X	X
ISOPROPYL ALCOHOL	X	X	X	X	X
FROSTY COLD BEVERAGE	X	X	X	X	X

FRONT SUSPENSION TORQUE TIGHTENING VALUES (ALL FORKS)

The following chart is a summary of the primary torque tightening values common to all RockShox forks. The torque tightening values for fasteners that require a specific torque are detailed in the text of each service section. Keep in mind your specific fork may not have all of the options listed in the chart below.

FRONT SUSPENSION FASTENER	TORQUE VALUE N·m (in-lb)
MOTION CONTROL IS COMPRESSION KNOB SCREW	1.0 (9)
TOP CAPS (EXCEPT AIR U-TURN)	7.3 (65)
TOP CAPS (AIR U-TURN ONLY)	14.7 (130)
BOTTOM BOLT (DAMPER SIDE)	6.8 (60)
BOTTOM NUT (AIR SIDE)	5.1 (45)
POPLOC/PUSHLOC REMOTE HANDLEBAR CLAMP BOLT	2.3 (20)
POPLOC/PUSHLOC REMOTE CABLE FIXING BOLT	0.9 (8)
U-TURN KNOB FIXING BOLT	1.4 (12)
DIRECT MOUNT STEM BOLTS	8.5 (75)
BRAKE MOUNT (DISC)	9-10 (80-88)
BRAKE MOUNT (CANTILEVER/LINEAR -PULL)	5-7 (43-61)

BUSHING INSPECTION, LOWER LEG REMOVAL, AND SEAL SERVICE

PURPOSE

The bushings and seals of your RockShox front suspension contribute to the consistent and plush feel of your fork. Performing routine service of the seals and periodic replacement the bushings and lower leg will help maintain your fork's performance as well as reduce overall maintenance costs. Removing the lower legs of your RockShox front suspension provides service access to the lower leg seals. It also provides service access to the damper and spring components of your suspension.

LOWER LEG BUSHING INSPECTION

INTRODUCTION

Suspension fork bushings are considered "wear and tear" parts. The rate and amount of wear will depend on the frequency of fork service, frequency of riding, riding terrain, rider body weight, and type of fork. The more you ride, the more frequently your bushings need to be replaced. If your bushings are worn, you will need to replace your lower leg assembly. The following chapter covers how to check for bushing wear.

CHECK FOR BUSHING WEAR

Symptoms of worn bushings that need to be replaced include, a "knocking" sound from the fork when riding, and/or the headset may feel loose when it isn't.

Method 1: On-bike check

1. Compress fork 5 times to circulate lower leg lube.
2. Hold the front brake lever tight and rock the bike back and forth. If the fork feels like it's "knocking", or the headset feels loose, proceed to steps 3 and 4.
3. Check the fork: wrap your fingers around the dust seal and upper tube area. Rock the bike back and forth again. Listen and feel if there is any play between the upper tube and the dust seal. If so, the bushings are loose.
4. Check the headset: wrap your fingers around the headset upper cup or lower cup/Race areas. Holding the brake, rock the bike back and forth and feel if the headset is loose. If so, tighten the headset and check again.

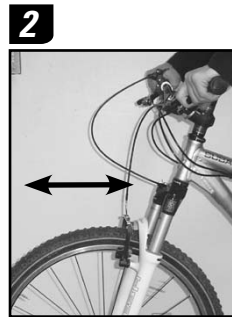

Method 2: Off-bike check

5. Compress fork 5 times to circulate lower leg lube (not pictured).
6. Hold the fork crown tight in one hand and the brake arch in the other hand. Try and move the brake arch back and forth. If you can feel any play, or if the fork feels like it's "knocking", the bushings are loose.

Note: You may wish to brace the fork on a table or on the floor to steady it.



Note: If you have determined that the bushings are loose and need to be replaced, you will need to replace the entire lower leg assembly. Reference the 2010 RockShox Spare Parts Catalog for information on the correct lower leg and corresponding part number for your fork.

LOWER LEG REMOVAL (ALL FORKS)

INTRODUCTION

Removing the lower legs of your front suspension is the first step in servicing your fork. Once you have removed your fork lower legs, you'll be ready to move onto the next section.

LOWER LEG REMOVAL INSTRUCTIONS

1. Remove the air chamber valve cover cap from the left fork leg top cap. If the fork has a negative air chamber (**Dual Air, Air U-Turn**), remove the negative air chamber valve cover cap from the bottom of the left fork leg.

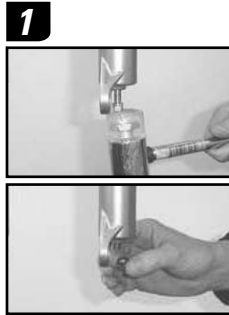

2. Depress the Schrader valve and release all of the air pressure from the air chamber. If the fork has a negative air chamber, start with the negative air chamber first, then proceed to the positive air chamber.

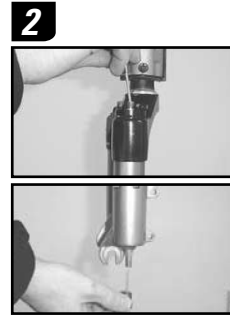

3. Remove the external rebound adjust knob by pulling it from the drive-side shaft bolt.
4. Use a 5 mm hex wrench to loosen both shaft bolts 3 to 4 turns. For **Dual Air** equipped forks, use a 10 mm socket (or open end) wrench to loosen and unthread the Dual Air shaft nut until it is flush with the threaded shaft end.



- Note: For hollow bottom fork legs you will need to use a deep 10 mm socket to loosen and unthread the Dual Air shaft nut.**

5. Place an oil pan beneath the fork to catch any draining oil. Use a plastic mallet to firmly strike each shaft bolt free from its press-fit to the lower leg and use your fingers to remove shaft bolts/nut completely.

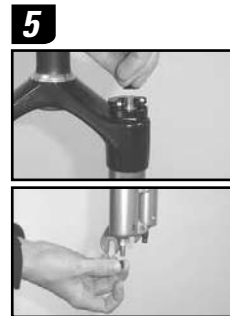
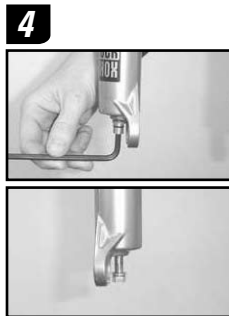

- Note: For hollow bottom fork legs tap the 5 mm hex wrench and 10 mm deep socket while engaged in the bolts to free them from the press-fit.**

6. Firmly pull the lower leg downward until oil begins to drain.

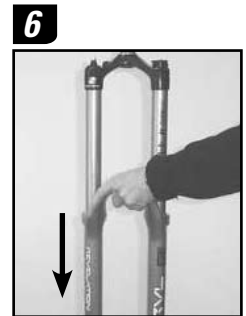

- Note: If the upper tubes do not slide out of the lower leg or if oil doesn't drain from either side, the press fit(s) may not be completely released. Re-install the shaft bolt(s) 2 to 3 turns (or Dual Air nut flush with the threaded shaft end) and strike again. Do not hit the brake arch with any tool when removing the lower leg as this could damage the fork.**

7. Remove the lower leg from the fork by pulling it downward, holding onto both legs or the brake arch.



8. Spray isopropyl alcohol on and into the lower leg assembly. Wipe the lower legs clean, then wrap a clean rag around a dowel and clean the inside of each lower leg.

LOWER LEG SEAL SERVICE (ALL FORKS)

INTRODUCTION

Suspension fork seals are considered "wear and tear" parts and require regular maintenance, depending on the frequency of riding, riding terrain, and type of fork. The more you ride, the more frequently your seals need to be replaced. The following chapter covers wiper and oil seal removal and installation. At this point you should already have the lower legs removed from your fork. If not, you will need to return to the Lower Leg Removal section of this manual and follow the instructions for removing your fork lower legs.

WIPER & OIL SEAL REMOVAL (ALL FORKS)

1. Select one side of the lower leg to work on. In that leg, position the tip of a downhill tire lever or large, flat head screwdriver underneath the lip of the lower black oil seal, above the upper bushing. If your fork does not have black oil seals, place the tip of the tool underneath the lip of the wiper seal.
2. Stabilize the lower leg upright on a bench top or on the floor. Hold the lower leg firmly and use downward force on the tool handle to leverage the seal(s) out. If your fork has an oil foam ring, remove it with your fingers.

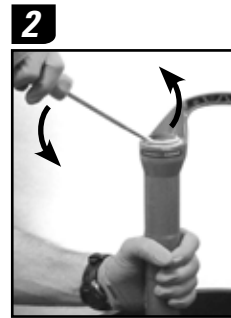
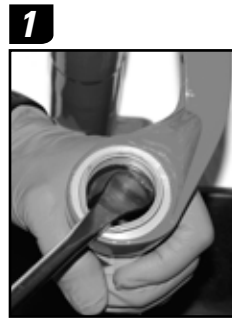

Important: Keep the lower leg assembly stable. Do not allow the lower legs to twist in opposite directions, compress toward each other or be pulled apart. This will damage the lower leg assembly.

3. If your fork has an oil foam ring, remove it with your fingers.
4. Repeat steps 1 - 3 for the other side of the lower leg.
5. Spray isopropyl alcohol on and into the lower leg. Wipe the lower legs clean, then wrap a clean, lint free rag around a dowel and clean the inside of each lower leg.

FOAM RING & WIPER SEAL INSTALLATION (REBA - RECON - REVELATION - TORA 318)

Foam ring installation

1. Soak the new foam rings in 15wt Pit-Stop suspension oil.
2. Insert a new oil-saturated foam ring into a lower leg.

Dust wiper seal installation

3. Position the dust wiper seal into the recessed side of the seal installation tool, so that the grooved side of the seal is visible.
4. Hold one of the lower legs firmly and use the seal installation tool to push the dust wiper evenly and completely into that leg.

Important: Be sure to stabilize the lower leg in order to prevent it from slipping while installing the seal.

Note: Check the foam ring under the wiper seal. The foam ring should not protrude from the wiper seal. If the foam ring protrudes, adjust it so that it is flush inside the lower leg on all sides.

5. Repeat steps 1-4 for the other side of the lower leg.

1



2



3



4



FOAM RING, WIPER & OIL SEAL INSTALLATION (ARGYLE - DOMAIN - LYRIK - PIKE - REBA - SID - TOTEM)

Oil seal installation

1. Position the oil seal, with the grooved side visible, onto the stepped side of the seal installation tool.
2. Hold one of the lower legs firmly and use the seal installation tool to push the oil seal evenly and completely into that leg. Repeat for the other leg.
Important: Be sure to stabilize the lower leg in order to prevent it from slipping while installing the seal.

1



2



Foam ring installation

3. **Note: For Domain, Lyrik, and Totem, please move onto wiper seal installation, step 6.**
4. Soak new foam ring in 15wt Pit-Stop suspension oil.
5. Insert new oil-saturated foam ring into lower leg on top of oil seal.

4



5



6

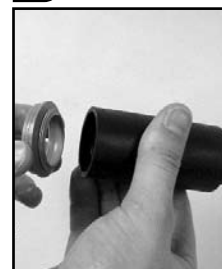

Dust seal installation

6. Position the dust wiper seal, with the grooved side visible, into the recessed side of the seal installation tool.
7. Hold one of the lower legs firmly and use the seal installation tool to push the dust wiper evenly and completely into that leg.
Important: Be sure to stabilize the lower leg in order to prevent it from slipping while installing the seal.
Note: Check the foam ring under the wiper seal. The foam ring should not protrude from the wiper seal. If the foam ring protrudes, adjust it so that it is flush inside the lower leg on all sides.
8. Repeat steps 1-7 for the other side of the lower leg.

7



DAMPER SERVICE

PURPOSE

Servicing the damper of your front suspension helps ensure consistent rebound and compression performance.

REBOUND & TURNKEY DAMPER SERVICE

(ARGYLE 302 - DART 2, 3 - DOMAIN 302 - LYRIK R - PIKE 327 - RECON 327, 335, XC, SL - TORA 289, 302, XC, SL)

INTRODUCTION

At this point you should already have the lower legs removed from your fork. If not, you will need to return to the Lower Leg Removal section of this manual and follow the instructions for removing your fork lower legs.

DAMPER REMOVAL/SERVICE INSTRUCTIONS

Note: For Dart 2, Lyrik R, Tora 289, and Tora XC please skip step 1 and move to step 2.

1. Remove the external snap ring from the compression adjuster knob using external snap ring pliers and remove the compression adjuster knob and o-ring.

OR

If the fork is equipped with a remote compression lockout feature, use a 2 mm hex wrench to loosen the cable pinch bolt and remove the cable. You do not need to remove the remote cable spool. Continue on to Step 2.

2. Unthread the compression damper top cap with a 24 mm socket wrench.

Note: for Argyle 302, Dart 2, Domain 302, and Tora 289 please move to step 5.

3. Remove the compression damper by pulling up and gently rocking it from side to side. If the fork is equipped with a remote lockout feature, be sure to remove the remote compression damper cable-stop clamp; which is located under the compression damper top cap. Once removed, clean the upper tube threads with a rag.

4. Use a pick to remove the compression damper top cap o-ring. Apply a few drops of Pit-Stop suspension oil to a new o-ring and install.

5. Remove the fork from the bicycle stand and pour any remaining oil into an oil pan.

Note: For Dart 2, this completes the removal procedures, please move to step 10.

6. Turn the fork upside down and push the rebound damper shaft through the shaft guide. Use a long dowel rod to help push the damper piston past the upper tube threads and remove the damper from the upper tube.

7. Use a pick to remove the rebound damper piston o-ring and damper inner seal-head o-ring (located in the bottom of the upper tube). Apply a few drops of Pit-Stop suspension oil to new o-rings and install.

Important: If using a pick to remove o-rings, do not scratch o-ring glands. Scratches may cause oil to leak.

1



2



3

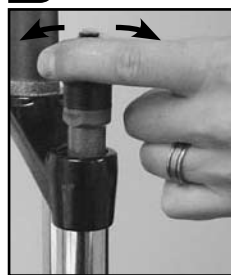

4



5



6

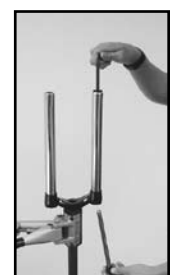

7



OPTIONAL - COMPRESSION DAMPER UPGRADE: NON-REMOTE TO REMOTE ADJUST

Upgrading from a non-remote compression adjust fork to a remote compression adjust (from a crown mounted adjuster knob to a remote PopLoc or PushLoc lever adjuster), requires replacing the non-remote compression damper with a remote compression damper and cable-stop clamp. The remote return spring is integrated into the compression damper and is required for use with the PopLoc and PushLoc remote lever assembly.

DAMPER INSTALLATION INSTRUCTIONS

8. Clamp the fork back into the bicycle stand and apply a light film of grease to the upper tube threads. Insert the rebound damper back into the drive side upper tube, shaft first, and push the piston into the upper tube.
9. Push the rebound damper into the upper tube using a long dowel rod. Guide the rebound damper shaft through the damper seal head at the bottom of the upper tube and pull the shaft through by hand into the fully extended position.
10. Measure and slowly pour 5wt Pit-Stop suspension oil into the upper tube using the volumes listed in the chart at right.
Important: Oil volume is critical. Too much oil reduces available travel, too little oil decreases damping performance.

Note: For Dart 2 and Tora 289 please move to step 12.

11. Remote Only: Position the cable-stop clamp in the 10 o'clock position around the upper tube hole on the crown prior to inserting the compression damper. Grease the upper tube threads liberally then insert the compression damper into the upper tube. Press down and twist to work the damper into the upper tube. Be careful not to damage the o-ring on the upper tube threads.
12. Press the top cap down into the upper tube threads and hand tighten. Using a 24 mm socket wrench, tighten to 7.3 N·m (65 in-lb).
Note: For Dart 2 and Tora 289, this completes the installation instructions. You are ready to move on to the next section in the manual: Spring Service.

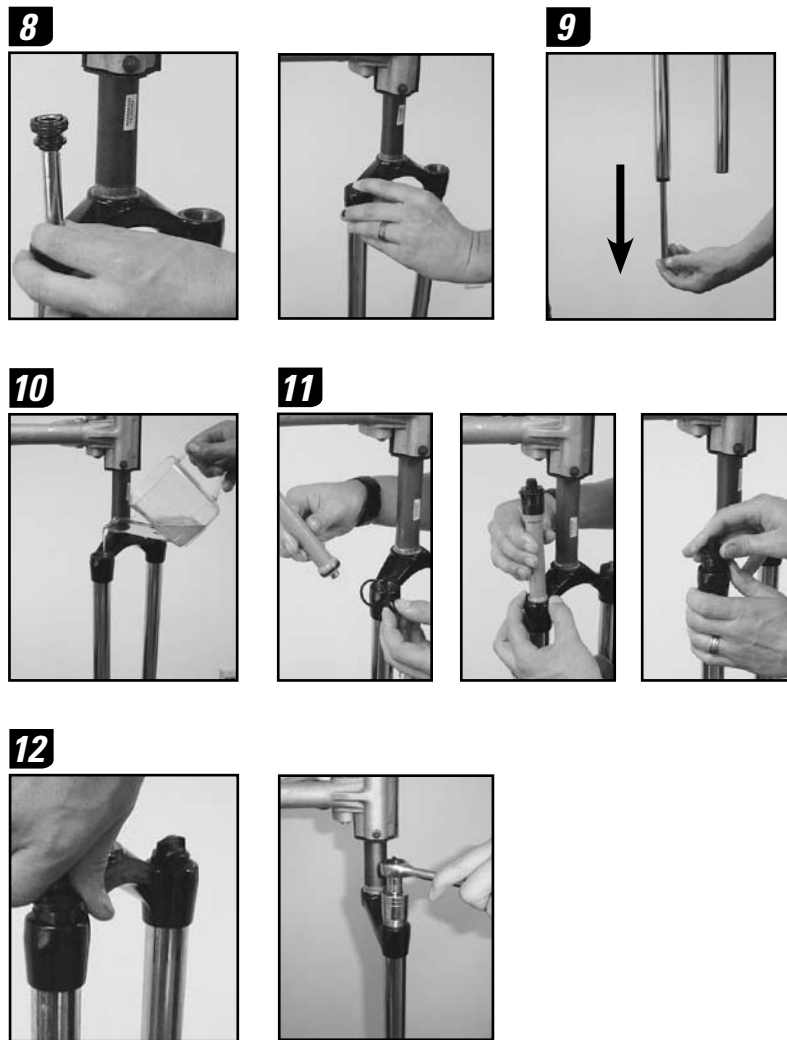

Fork	Oil Volume (±3 mL)
Argyle 302	130 mL
Dart 2	150 mL
Dart 2 (with Turnkey), Dart 3:	
80-100 mm	93 mL
120mm	109 mL
Domain 302	200 mL
Lyrík R	145 mL
Pike 327	120 mL
Recon 327,335, XC, SL	120 mL
Tora 289, 302, XC, SL	120 mL

DAMPER INSTALLATION INSTRUCTIONS (CONTINUED)

13. For forks equipped with crown mounted (non-remote) compression adjusters, turn the hex-shaped compression adjuster counter-clockwise to the open position. Place the compression adjuster knob onto the compression damper top cap with the knob dial set in the 3 o'clock position. Using external snap ring pliers, secure the compression adjuster knob with a new snap ring.
14. For forks equipped with a remote compression lockout feature, move on to the Remote Service section for instructions on how to install the remote lever and cable assembly.

13



This concludes the damper service for your fork. You did a great job! You are now ready to move on to the next section: Spring Service.

MOTION CONTROL DAMPER SERVICE

(ARGYLE 318, 409- DOMAIN 318 - LYRIK IS - TORA 318 - TOTEM IS)

INTRODUCTION

At this point you should already have the lower legs removed from your fork. If not, you will need to return to the Lower Leg Removal section of this manual and follow the instructions for removing your fork lower legs.

DAMPER REMOVAL/SERVICE INSTRUCTIONS

Note: For Argyle 318 and 409, it is not necessary to remove the Motion Control knob, please skip step 1 and move to step 2.

1. Remove the external snap ring from the compression adjuster knob using external snap ring pliers and the remove compression adjuster knob and o-ring seal.

OR

If the fork is equipped with a remote compression lockout feature, use a 2 mm hex wrench to loosen the cable pinch bolt and remove the cable. You do not need to remove the remote cable spool. Continue on to Step 2.

OR

If the fork is equipped with Motion Control IS, use a 2 mm hex to remove the screw from the compression the adjuster knob. Remove the compression adjuster knob (not pictured).

2. Unthread the compression damper top cap with a 24 mm socket wrench.
3. Remove the compression damper from the upper tube/crown by pulling up and rocking it from side to side. If the fork is equipped with a remote, be sure to remove the remote compression damper cable-stop clamp; which is located under the compression damper top cap. Once removed, clean the upper tube threads with a rag.
4. With a pick, remove the compression damper top cap o-ring (located at the top of the damper) and the compression damper seal (located at the bottom of the damper). Apply a few drops of Pit-Stop suspension oil to the new o-ring and seal and install it.

Important: If using a pick to remove inner seal head o-ring, do not scratch o-ring gland. Scratches may cause oil to leak.

5. Remove the fork from the bicycle stand and pour any remaining oil into an oil pan.
6. Turn the fork upside down. Push the rebound damper shaft into the upper tube/seal head and remove the rebound damper from the upper tube.
7. Remove the rebound damper glide ring and inner seal head o-ring. Apply fresh grease to the new o-rings and install them.

1



2



3

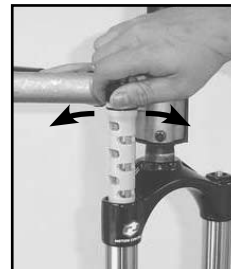

4



5



6

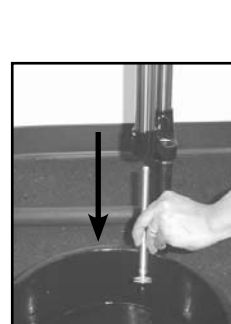

7



OPTIONAL - COMPRESSION DAMPER UPGRADE: NON-REMOTE TO REMOTE ADJUST (TORA 318 ONLY)

Upgrading from a non-remote compression adjust fork to a remote compression adjust (from a crown mounted adjuster knob to a remote PopLoc or PushLoc lever adjuster), requires replacing the non-remote compression damper with a remote compression damper and cable-stop clamp. The remote return spring is designed into the compression damper and is required for use with the PopLoc and PushLoc remote lever assembly.

DAMPER INSTALLATION INSTRUCTIONS

8. Clamp the fork back into the bicycle stand. Insert the rebound damper back into drive side upper tube, shaft first. Guide the rebound damper through the damper seal head at the bottom of the upper tube and pull through.
9. Thread the shaft bolt into the rebound damper shaft end and pull the rebound damper shaft down through the seal head into the fully extended position.
10. Measure and slowly pour 5wt Pit-Stop suspension oil into the upper tube, using the following volumes:

Fork	Oil Volume (±3 mL)
Argyle 318, 409	130 mL
Domain 318	200 mL
Tora 318:	
Coil, Coil-Turn	150 mL
Solo Air	130 mL

Important: Oil volume is critical. Too much oil reduces available travel, too little oil decreases damping performance.

11. Remote Only: Slide the compression damper through the cable-stop clamp prior to insertion. Position the cable-stop clamp in the 10 o'clock position on the crown.
12. Grease the upper tube threads liberally, then insert the compression damper into the upper tube. Press down and rock the compression damper from side to side to work it into the upper tube.
13. As soon as the damper seal passes through the upper tube threads, pull the damper up slightly, then push back down. The compression damper should slide up and down easily, indicating that the seal is in the proper position, and not folded over. Repeat this procedure until the compression damper slides up and down easily. Then press the compression damper down until the upper o-ring contacts the upper tube threads.

8



9

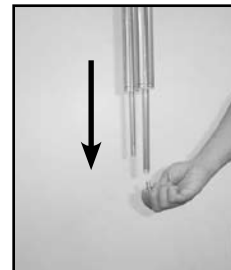

10



11



12

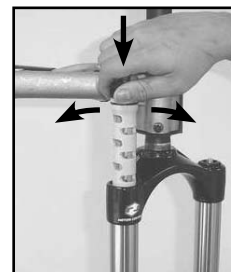

13

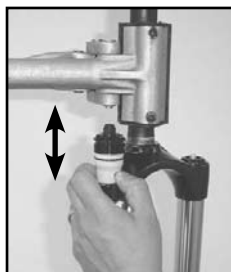

DAMPER INSTALLATION INSTRUCTIONS (CONTINUED)

14. Turn the damper clockwise to thread it into the upper tube. Be careful not to damage the damper top cap o-ring. Using a 24 mm socket wrench, tighten to 7.3 N-m (65 in-lb).

Note: For Argyle 318 and 409 this completes the installation process.

15. For forks equipped with crown mounted (non-remote) compression adjusters, turn the hex-shaped compression adjuster counter-clockwise to the open position. Place the compression adjuster knob onto the compression damper top cap with the knob dial set in the 3 o'clock position. Using external snap ring pliers, secure the compression adjuster knob with a new snap ring.
16. For forks equipped with a remote compression lockout feature, move on to the Remote Service section for instructions on how to install the remote lever and cable assembly.

This concludes the damper service for your fork. You did a great job! You are now ready to move on to the next section: Spring Service.

14



15



MOTION CONTROL/BLACKBOX MOTION CONTROL DAMPER SERVICE

(PIKE 409, 426, 454 - REBA SL, RACE, TEAM - RECON 351, RACE - REVELATION SL, RACE, TEAM -
SID RACE, TEAM, WC)

INTRODUCTION

At this point you should already have the lower legs removed from your fork. If not, you will need to return to the Lower Leg Removal section of this manual and follow the instructions for removing your fork lower legs.

DAMPER REMOVAL/SERVICE INSTRUCTIONS

Crown mounted compression adjusters:

Motion Control only: Remove the external snap ring from the compression adjuster knob using small external snap ring pliers and remove the compression adjuster knob and o-ring seal.

Recon 351, Race only: Remove the detent leaf spring from the top cap.

Blackbox Motion Control only: Remove the floodgate knob using a 1.5 mm hex wrench and remove the compression adjuster knob and o-ring seal.

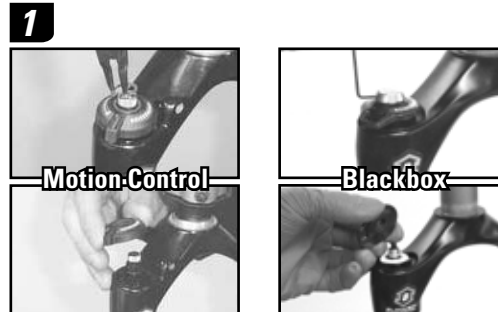

OR

Remote mounted compression adjusters:

Motion Control only: Remove the external snap ring from the compression adjuster spool using external snap ring pliers. Remove the compression adjuster spool and white top cap seal.

Recon Race, SL only: Use a 2 mm hex wrench to loosen the cable stop clamping bolt. Remove the cable stop.

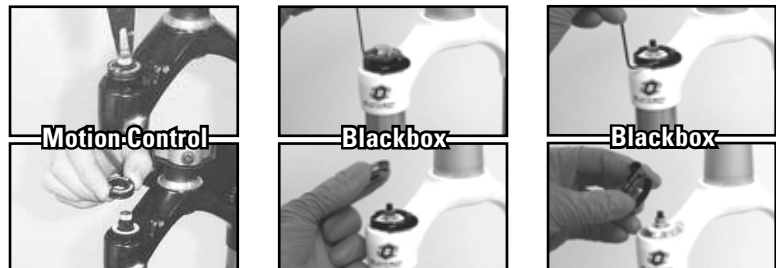

Blackbox Motion Control only: Use a 2 mm hex wrench to loosen the cable stop clamping bolt. Remove the cable stop. Use a 1.5 mm hex wrench to loosen the floodgate knob pinch bolt. Remove the floodgate knob. Remove the compression adjuster spool and white top cap seal.



1. Unthread the compression damper top cap with a 24 mm socket wrench.
2. Remove the compression damper from the upper tube/crown by pulling up and rocking it from side to side. Once removed, clean the upper tube threads with a clean rag.
3. With a pick, remove the compression damper o-rings (located at the top and bottom of the damper). Apply a few drops of Pit-Stop suspension oil to new o-rings and install.
4. Remove the fork from the bicycle stand and pour any remaining oil into an oil pan.

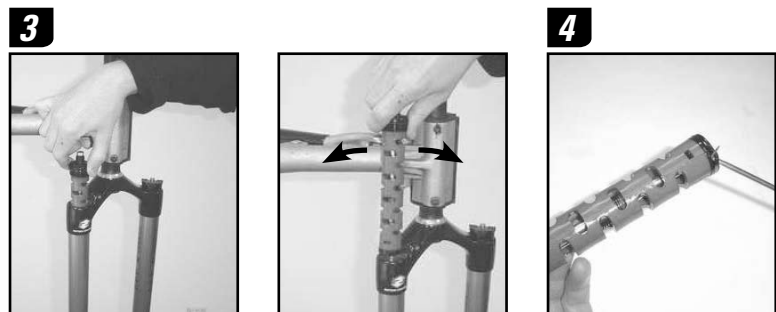

DAMPER REMOVAL/SERVICE INSTRUCTIONS (CONTINUED)

5. Push the rebound shaft into the seal head, leaving just enough shaft exposed to hold onto with your fingers. Use large internal snap ring pliers to remove the rebound damper seal head retaining ring (located inside the bottom of the drive side upper tube). Pull down and remove the rebound damper and seal head assembly from the upper tube.



6. Slide the seal head off the damper shaft and use a pick to remove the inner and outer seal head o-rings. Apply a few drops of Pit-Stop suspension oil to new o-rings and install them.

7. Spray isopropyl alcohol on the rebound damper shaft and wipe it with a clean rag.

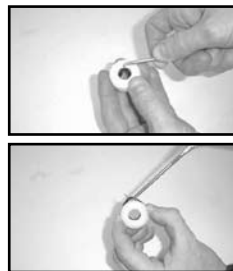

8. Replace the rebound damper piston glide ring. Position the upper tube base ring on top of the seal head step and slide the rebound seal head assembly onto the rebound damper shaft.

9. Spray isopropyl alcohol into the upper tube. Wrap a clean rag around a dowel and clean the inside of the upper tube.



10. Insert the rebound damper piston into the bottom of the upper tube at an angle, with the side of the glide ring opposite the split entering the upper tube first. Continue to angle and rotate until the glide ring is in the upper tube.

9

11. Position the upper tube base ring and rebound seal head into the upper tube. Push the seal head firmly into the bottom of the upper tube until the retaining ring groove is visible.

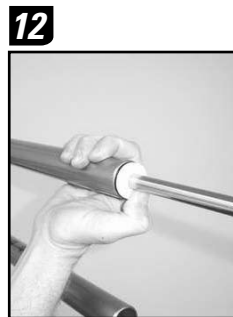
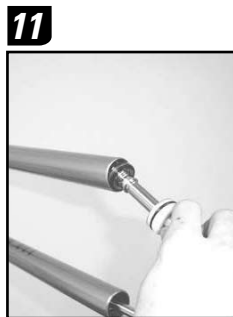

11

12

OPTIONAL - COMPRESSION DAMPER UPGRADE: NON-REMOTE TO REMOTE ADJUST

Upgrading from a non-remote compression adjust fork to a remote compression adjust (from a crown mounted adjuster knob to a remote PopLoc or PushLoc lever adjuster), requires replacing the non-remote compression damper with a remote compression damper and cable-stop clamp. The remote return spring is designed into the compression damper and is required for use with the PopLoc and PushLoc remote lever assembly.

DAMPER INSTALLATION INSTRUCTIONS

12. Push the rebound damper shaft into the seal head, leaving just enough to grab onto. Use large internal snap ring pliers to secure the snap ring into the snap ring groove.

Important: Make sure the snap ring is securely fastened in the snap ring groove. You can check this by using the snap ring pliers to rotate the snap ring back and forth a couple of times, then firmly pulling down on the damper shaft.

Note: Snap rings have a sharper-edged side and a rounder-edged side. Installing snap rings with the sharper-edged side facing towards the tool will allow for easier installation and removal.

13. Orient the fork upright in the bicycle stand. Pull the rebound damper shaft down to the fully extended position. Measure and slowly pour 5wt Pit-Stop suspension oil into the upper tube, using the following volumes:

13



14



Fork	Oil Volume (±3 mL)
Pike 409, 426, 454	120 mL
Reba SL, Race, Team	123 mL
Recon 351:	
standard axle	130 mL
thru axle	138 mL
Recon Race	123 mL
Revelation SL, Race	123 mL
Revelation Team	133 mL
SID Race	94 mL
SID Team, WC	96 mL

15

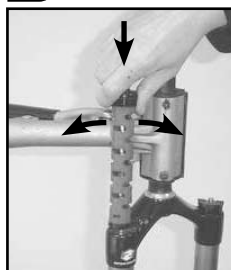

Important: Oil volume is critical. Too much oil reduces available travel, too little oil decreases damping performance.

14. Insert the compression damper into the upper tube. Press down and rock the damper from side to side to work it into the upper tube.

DAMPER INSTALLATION INSTRUCTIONS (CONTINUED)

15. Turn the damper clockwise to thread it into the upper tube. Be careful not to damage the damper top cap o-ring. Continue to thread the top cap down into the upper tube threads and hand tighten. Use a 24 mm socket wrench to tighten to 7.3 N·m (65 in·lb.)

Note: Turn the hex-shaped compression adjuster counter-clockwise to the open position.

16

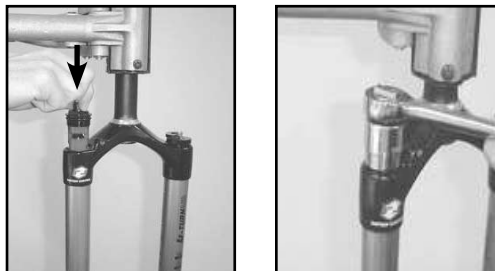

Recon 351, Race only: With the hex-shaped compression adjuster in the fully open position, re-install the detent leaf spring onto the top cap so that the ends of the leaf spring are located at the 9 o'clock and 3 o'clock positions.

16. Place the compression adjuster knob onto the compression damper top cap with the knob dial set in the 3 o'clock position (Recon 351, Race only: 2 o'clock position).

Crown mounted compression adjusters:

Motion Control only: Using small external snap ring pliers, secure the compression adjuster knob with a new snap ring.

Blackbox Motion control only: Reinstall the floodgate knob and use a 1.5 mm hex wrench to turn the set screw clockwise until it stops.

OR

Remote mounted compression adjusters:

Motion Control only: If the fork is equipped with a remote compression lockout feature, place the remote spool onto the compression damper top cap with the cable set screw in the 3 o'clock position (Recon 351, Race only: 2 o'clock position). Use small external snap ring pliers to secure the remote spool with a new snap ring.

Blackbox Motion control only: If the fork is equipped with a remote compression lockout feature, reinstall the cable stop onto the compression damper top cap with the cable stop facing toward the front of the fork, perpendicular to the crown. Tighten the cable stop clamping bolt to firmly secure the cable. Place the remote spool onto the compression damper top cap with the cable set screw in the 3 o'clock position. Reinstall the floodgate knob and use a 1.5 mm hex wrench to turn the set screw clockwise until it stops.

For forks equipped with a remote compression lockout feature, move on to the Remote Service section for instructions on how to install the remote lever and cable assembly.

This concludes the damper service for your fork. You did a great job! You are now ready to move on to the next section: Spring Service.

17

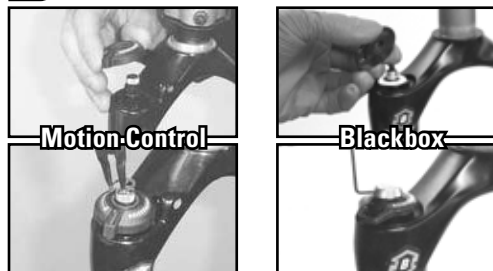

OR

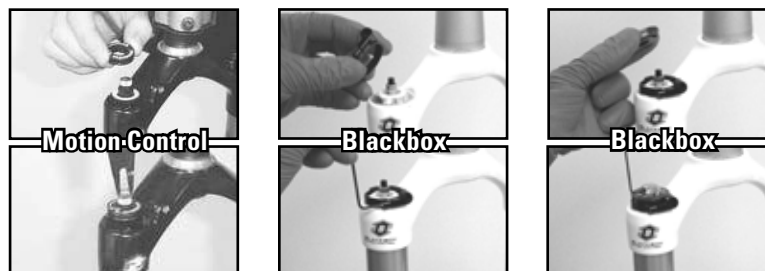

REMOTE SERVICE

(PUSHLOC - POPLOC ADJUST - POPLOC)

INTRODUCTION

Damper service for forks equipped with remote compression damping adjusters will require cable and housing removal and installation. Also, periodic replacement of the cable and housing is recommended for optimal remote performance.

CABLE REMOVAL INSTRUCTIONS

- 1. PushLoc only:** Push the remote lever until it returns toward you.
PopLoc and PopLoc adjust only: Press the button next to the remote lever to set the lever to the fully released (Open) position.
- For Blackbox Motion Control, use a 2 mm hex wrench to loosen the cable pinch bolt on the rotating cam and pull the cable out of the cam slot. Use pliers to remove the cable end cap.
OR
For Motion Control, use a 2 mm hex wrench to loosen the cable pinch bolt on the rotating cam. Use pliers to remove the cable end cap.
- 3. PushLoc only:** Push the remote lever to the 'Closed' position. Use your finger to open the cable hatch cover. Push the cable through the rotating cam on the fork until the cable head is far enough out of the lever to grab onto.
PopLoc and PopLoc adjust only: Push the cable through the rotating cam until the cable head is far enough out of the lever to grab onto.
- Pull the cable head to remove the cable completely from the remote system.
- If replacing the cable housing, detach the cable housing and end caps from the lever and the cable housing stop on the fork.

1

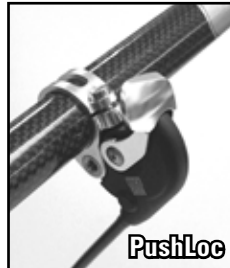

2

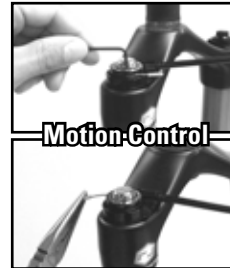
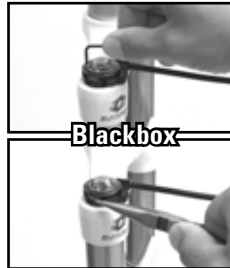

3



CABLE INSTALLATION INSTRUCTIONS

6. If replacing the cable housing, attach the new housing and end caps to the remote lever and the cable housing stop on the fork. Be sure to use compressionless housing cut to an adequate length to accommodate for travel change and suspension movement.

7. For PopLoc and PopLoc adjust, push the release button to verify the remote is in the 'Open' position.

For PopLoc adjust, turn the blue compression adjustment dial counter-clockwise until it stops.

8. Insert the tip of a new shifter cable into the port on the lever and feed the cable through the housing and the cable housing stop on the fork.

9. Pull the cable until the cable head is seated completely in the remote lever.

PushLoc only: Once the cable head is seated in the remote lever body, close the cable hatch cover and push the lever to return it to the 'Open' position.

10. For BlackBox Motion Control, wrap the cable around the rotating cam and insert it through the cable fixing port. While pulling the cable firmly, use a 2 mm hex wrench to tighten the cable fixing bolt to 0.9 N-m (8 in-lb). Cut the excess cable, leaving 30 mm protruding from the cable fixing port. Cap the end of the cable with a non-flanged, or "road style" cable end fitting. Tuck the cable end and fitting into the cable end pocket in the rotating cam.

OR

For Motion Control, wrap the cable around the rotating cam. While pulling the cable firmly, use a 2 mm hex wrench to tighten the cable fixing bolt to 0.9 N-m (8 in-lb). Cut the excess cable and cap it with a cable end fitting.

7



8

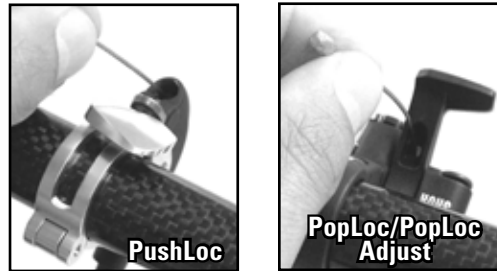

9



16



MISSION CONTROL DAMPER SERVICE

(LYRIK - TOTEM)

INTRODUCTION

At this point you should already have the lower legs removed from your fork. If not, you will need to return to the Lower Leg Removal section of this manual and follow the instructions for removing your fork lower legs.

DAMPER REMOVAL/SERVICE INSTRUCTIONS

1. Turn the blue high speed compression knob clockwise, to set it in the maximum compression position.
2. Turn the Floodgate to the "off" position by pushing the low speed compression adjuster down and rotating it counter-clockwise 90°.
3. Unthread the compression damper top cap with a 24 mm flat wrench. Access to the top cap is under the high speed compression knob.

OR

Insert a 2.5 mm hex wrench into the low speed compression knob and turn it counter-clockwise until it stops. This allows maximum insertion depth for the 4 mm wrench. Gently grasp the low speed compression knob with the slip joint pliers, then use a 4 mm hex wrench to remove the Floodgate knob retention screw. Lift and remove the low speed compression knob. Then use a 1.5 mm hex wrench to loosen both retaining bolts on the high speed compression knob. Remove the high speed compression knob. This allows access to the top cap. Unthread the compression damper top cap using a 24 mm socket wrench.

4. Remove the compression damper from the upper tube/crown by pulling up and rocking it from side to side. Once removed, clean the upper tube threads with a clean rag.
5. Remove the glide ring from the compression damper piston assembly. Apply a few drops of Pit-Stop suspension oil to the new glide ring and install.
6. Remove the fork from the bicycle stand and pour any remaining oil into an oil pan. Return the fork to the bicycle stand.
7. Push the rebound shaft into the seal head, leaving just enough shaft exposed to hold onto with your fingers. Use large internal snap ring pliers to remove the rebound damper seal head snap ring (located inside the bottom of the right upper tube).

2



3



OR



4

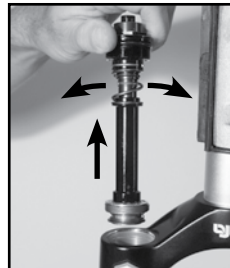

5



6



7



DAMPER REMOVAL/SERVICE INSTRUCTIONS (CONTINUED)

8. Firmly pull on the rebound shaft and remove the rebound damper and seal head from the upper tube.
9. Spray the rebound damper shaft with isopropyl alcohol, and wipe it with a clean rag.
10. Remove the inner and outer o-rings from the rebound seal head. Apply a few drops of Pit-Stop suspension oil to the new o-rings and install them.

Important: If using a pick to remove the inner seal head o-ring, do not scratch the o-ring gland. Scratches may cause oil to leak.

11. Remove the glide ring from rebound shaft assembly. Apply a few drops of Pit-Stop suspension oil to the new glide ring and install it.

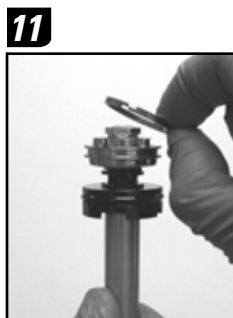
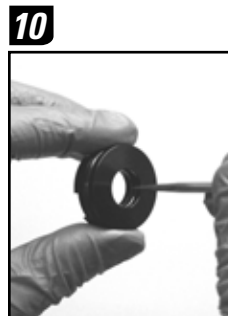
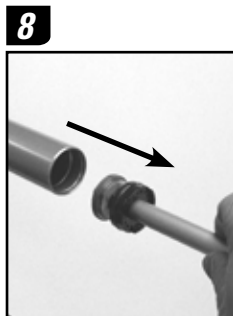

DAMPER INSTALLATION INSTRUCTIONS

12. Install the rebound assembly into the upper tube. Push the seal head firmly into the bottom of the upper tube until the retaining ring groove is visible. Push the rebound shaft into the seal head, leaving just enough shaft exposed to hold onto with your fingers. Use large internal snap ring pliers to install the snap ring.

Important: Make sure the snap ring is securely fastened in the snap ring groove. You can check this by using the snap ring pliers to rotate the snap ring back and forth a couple of times, then firmly pulling down on the damper shaft.

Note: Snap rings have a sharper-edged side and a rounder-edged side. Installing snap rings with the sharper-edged side facing the tool will allow for easier installation and removal.

13. Orient the fork upright in the bicycle stand. Pull the rebound damper shaft down into the fully extended position.

14. Measure and pour 5wt Pit-Stop suspension oil into the upper tube using the following volumes:

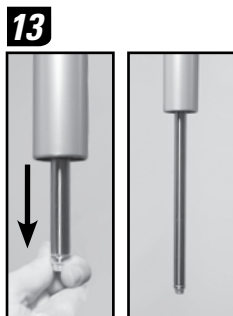
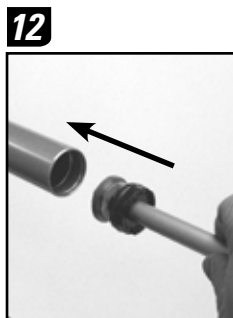

Fork	Oil Volume (±3 mL)
Lyrik	193 mL
Totem	203 mL

Important: Oil volume is critical. Too much oil reduces available travel, too little oil decreases

DAMPER INSTALLATION INSTRUCTIONS (CONTINUED)

damping performance.

15. Double check the Floodgate to ensure it is in the "off" position. Install the Mission Control damper assembly into the upper tube. Hand thread the compression damper top cap into the upper tube. Use a 24 mm flat wrench and tighten the top cap to 7.3 N·m (65 in-lb).

OR

Double check the Floodgate to ensure it is in the "off" position. Insert the Mission Control damper assembly into upper tube. Hand thread the compression damper top cap into the upper tube. Use a 24 mm socket wrench to tighten the top cap to 7.3 N·m (65 in-lb). Install the high speed compression knob using a 1.5 mm hex wrench to tighten the retaining bolts. Install the low speed compression knob by gently grasping it with slip joint pliers and using a 4 mm hex wrench to tighten the Floodgate knob retention screw.

This concludes the damper service for your fork. You did a great job! You are now ready to move on to the next section: Spring Service.

15

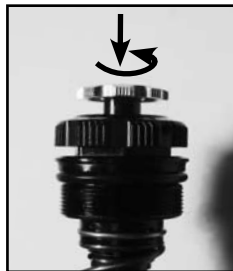

OR

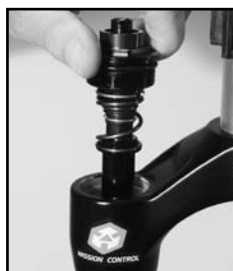

SPRING SERVICE

PURPOSE

Servicing your fork spring helps to reduce friction and ensure consistent, reliable performance from your front suspension.

COIL SPRING SERVICE

(ARGYLE 302, 318 - DART 1, 2, 2 (WITH TURNKEY), 3 - DOMAIN 302, 318 - TORA 289, 302, 318)

INTRODUCTION

At this point you should already have the lower legs removed from your fork. If not, you will need to return to the Lower Leg Removal section of this manual and follow the instructions for removing your fork lower legs.

COIL SPRING REMOVAL INSTRUCTIONS

1. Unthread and remove the spring top cap with a 24 mm socket wrench.
Important: Press down firmly when loosening the top cap.
2. **Argyle 302, 318 only:** Remove the spring pre-load spacer(s).
3. Push the spring shaft upward, from the bottom of the upper tube, then remove the coil spring and spring spacers from the upper tube.
4. Turn the fork upside down and slide the spring shaft assembly out of the upper tube. Remove the spring shaft assembly. Clean the spring shaft assembly and inspect it for damage.
5. Spray isopropyl alcohol on the spring, spring shaft assembly and the inside and outside of the upper tube and wipe with a clean rag. Wrap a clean rag around a long dowel and insert it into the upper tube to clean inside the upper tube.

1



2

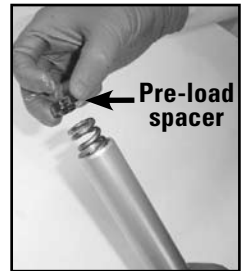

3

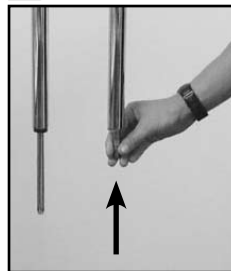

4

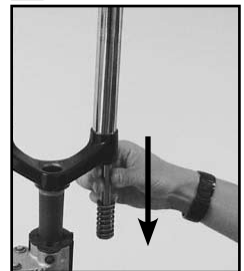

COIL SPRING INSTALLATION INSTRUCTIONS

6. Insert the spring shaft assembly into the upper tube from the top. Guide the threaded end through the shaft guide at the bottom of the upper tube and gently pull the shaft through to full extension.
7. Apply fresh grease liberally to the coil spring/spring spacer assembly.
8. Insert the coil spring/spring spacer assembly into the upper tube from the top.
9. **Argyle 302, 318 only:** Install the spring pre-load spacers onto the coil spring.
10. Clean the top cap, then apply a small amount of grease to the top cap threads. Insert and hand thread the top cap into the upper tube. Using a 24 mm socket wrench, tighten the top cap to 7.3 N·m (65 in·lb).

6

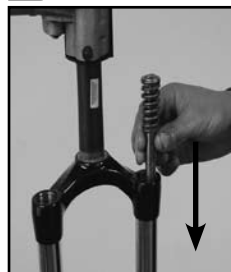

7



8

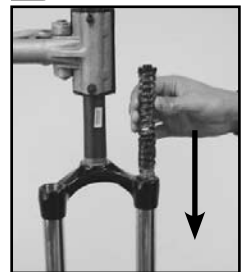

9

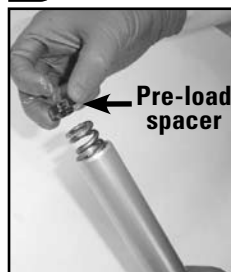

10



COIL SPRING SERVICE

(TORA XC, SL, RECON XC, SL, RACE)

INTRODUCTION

At this point you should already have the lower leg removed from your fork. If not, you will need to return to the Lower Leg Removal section of this manual and follow the instructions for removing your fork lower legs.

COIL SPRING REMOVAL INSTRUCTIONS

1. Use a 2.5 mm hex wrench to remove the preload adjuster knob screw, then remove the adjuster knob. Use a magnet to remove the detent balls and springs from the top cap.
2. Unthread and remove the spring top cap with a 24 mm socket wrench.
Important: press down firmly when loosening the top cap.
3. Push the spring shaft upward, from the bottom of the upper tube, then remove the coil spring and spring shaft from the upper tube.
4. Spray isopropyl alcohol on the spring, spring shaft assembly and the inside and outside of the upper tube and wipe with a clean rag. Wrap a clean rag around a long dowel and insert it into the upper tube to clean inside the upper tube.
5. Use a pick to remove the o-ring from the preload adjuster on top of the spring. Apply grease to the new o-ring and install it.

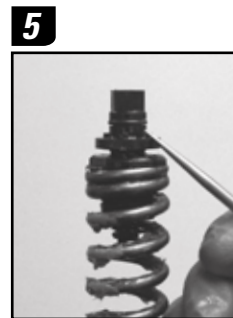
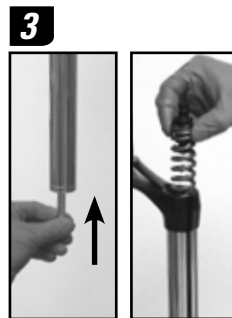
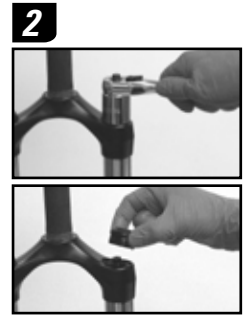
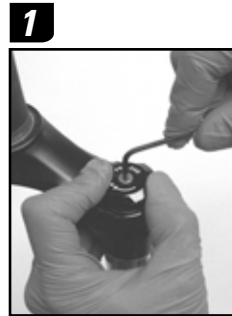

COIL SPRING INSTALLATION INSTRUCTIONS

6. Apply fresh grease liberally to the spring.
7. Insert the spring shaft and spring assembly back into the upper tube.
8. Clean the top cap, then apply a small amount of grease to the top cap threads. Insert and hand thread the top cap into the upper tube. Use a 24 mm socket wrench to tighten it to 7.3 N·m (65 in-lb).
9. Re-install the detent springs and balls into the top cap. Re-install the preload adjuster knob and knob screw. Tighten the preload adjuster knob screw with a 2.5 mm hex wrench to 1.4 N·m (12 in-lb).

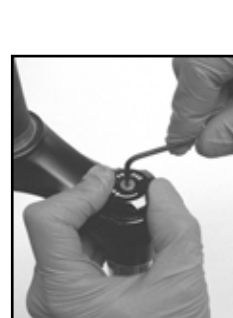
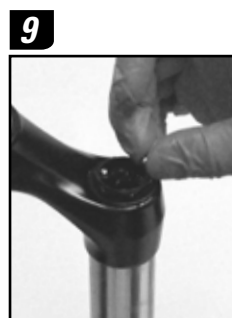
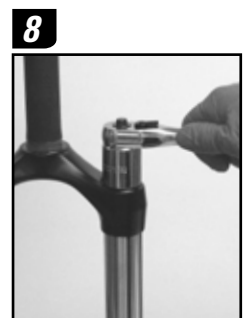
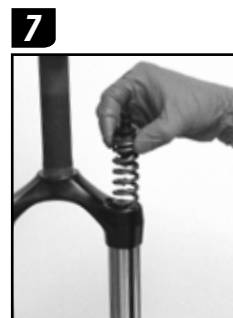
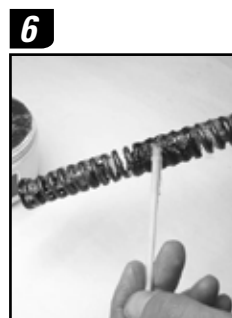

COIL SPRING SERVICE

(TOTEM - LYRIK)

INTRODUCTION

At this point you should already have the lower legs removed from your fork. If not, you will need to return to the Lower Leg Removal section of this manual and follow the instructions for removing your fork lower legs.

COIL SPRING REMOVAL INSTRUCTIONS

1. Unthread and remove the spring top cap with a 24 mm socket wrench.
Important: Press down firmly when loosening the top cap.
2. Remove the spring pre-load spacer(s) and pull the spring from the upper tube.
3. Remove the spring shaft base plate snap ring using internal snap ring pliers.
4. Pull the spring shaft and base plate assembly from the upper tube. Clean and inspect the assembly for damage. Replace the entire assembly if necessary.
5. Spray isopropyl alcohol on the spring, spring shaft and the inside and outside of the upper tube and wipe with a clean rag. Wrap a clean rag around a long dowel and insert it into the upper tube to clean inside the upper tube.

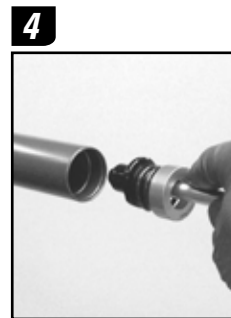
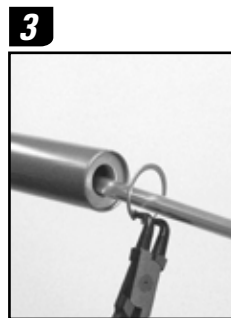
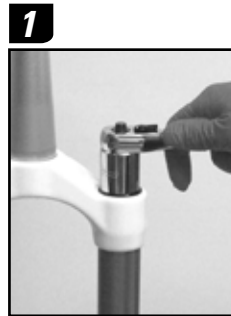

COIL SPRING INSTALLATION INSTRUCTIONS

6. Insert the spring shaft/base plate assembly into the bottom of upper tube so the base plate is seated against the upper tube step. Secure the spring shaft/base plate assembly with the snap ring, using large internal snap ring pliers.
7. Apply fresh grease liberally to the spring.
8. Insert the spring back into the upper tube and place the spring preload spacer(s) on top of the spring inside the upper tube.
9. Clean the top cap, then apply a small amount of grease to the top cap threads. Insert and hand thread the top cap into the upper tube. Use a 24 mm socket wrench to tighten to 7.3 N·m (65 in·lb).

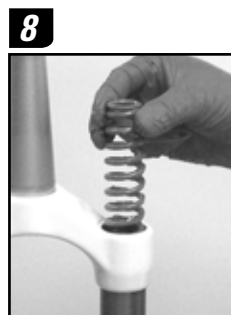
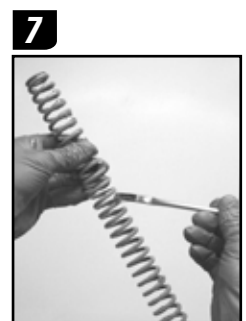
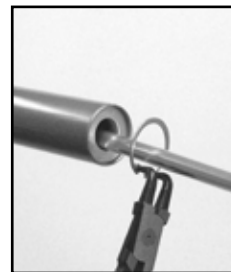

COIL U-TURN SPRING SERVICE

(DOMAIN 302, 318 - TORA 289, 302, 318)

INTRODUCTION

At this point you should already have the lower legs removed from your fork. If not, you will need to return to the Lower Leg Removal section of this manual and follow the instructions for removing your fork lower legs.

COIL U-TURN SPRING REMOVAL INSTRUCTIONS

1. Remove the U-Turn adjuster knob screw with a 2.5 mm hex wrench and remove the U-Turn adjuster knob.
2. Remove the three detent ball bearings and detent springs from the top cap using a magnet.
3. Unthread and remove the spring top cap with a 24 mm socket wrench. The spring is attached to the top cap and spring shaft. Pull and lift the entire spring assembly from the upper tube.

Important: Press down firmly when loosening the top cap.

4. Turn the fork upside-down to remove the U-Turn negative spring assembly from the upper tube.
5. Spray isopropyl alcohol on the entire spring assembly, negative spring, and the inside and outside of the upper tube and wipe with a clean rag. Wrap a clean rag around a long dowel and insert it into the upper tube to clean inside the upper tube.

1



2



3



4



COIL U-TURN SPRING INSTALLATION INSTRUCTIONS

6. Apply fresh grease liberally to the negative spring, the entire spring assembly, and the top cap threads.
7. Insert the negative spring into the upper tube from the top.
8. Insert the U-Turn spring assembly into the upper tube from the top, shaft end first. Align and seat the spring shaft through the shaft guide/base plate.
9. Insert and hand thread the top cap into the upper tube. Use a 24 mm socket wrench to tighten to 7.3 N·m (65 in·lb).
10. Place the adjuster detent springs into the top cap detent holes, evenly spaced. Place a detent ball bearing on top of each detent spring.
Important: Make sure you use all three springs and bearings, otherwise the knob can turn and change travel on its own.
11. Place the U-Turn adjuster knob on top of hex-shaped adjuster. Tighten the U-Turn adjuster knob screw with a 2.5 mm hex wrench to 1.4 N·m (12 in·lb).

6



7

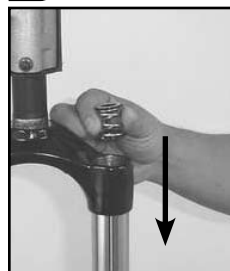

8

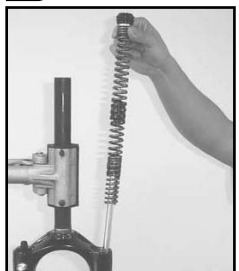

9

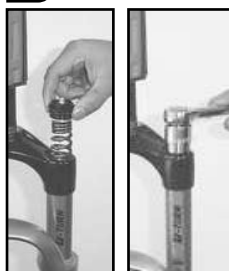

10

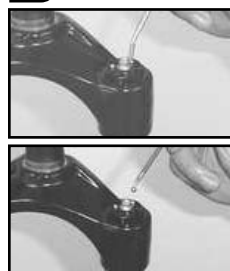

11

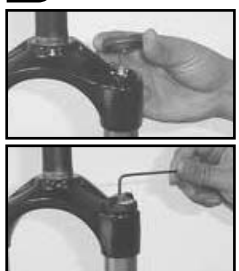

COIL U-TURN SPRING SERVICE

(LYRIK - PIKE 327, 351, 409, 426, 454 - RECON 327, 335, 351)

INTRODUCTION

At this point you should already have the lower leg removed from your fork. If not, you will need to return to the Lower Leg Removal section of this manual and follow the instructions for removing your fork lower legs.

COIL U-TURN SPRING REMOVAL INSTRUCTIONS

1. Remove the U-Turn knob screw with a 2.5 mm hex wrench and remove the U-Turn adjuster knob.
2. Remove the three detent ball bearings and detent springs from the top cap using a magnet.
3. Unthread and remove the spring top cap with a 24 mm socket wrench. The spring is attached to the top cap and spring shaft. Pull and lift the entire spring assembly from the upper tube.
Important: Press down firmly when loosening the top cap.
4. Spray isopropyl alcohol on the entire spring assembly and the inside and outside of the upper tube and wipe with a clean rag. Wrap a clean rag around a long dowel and insert it into the upper tube to clean inside the upper tube.

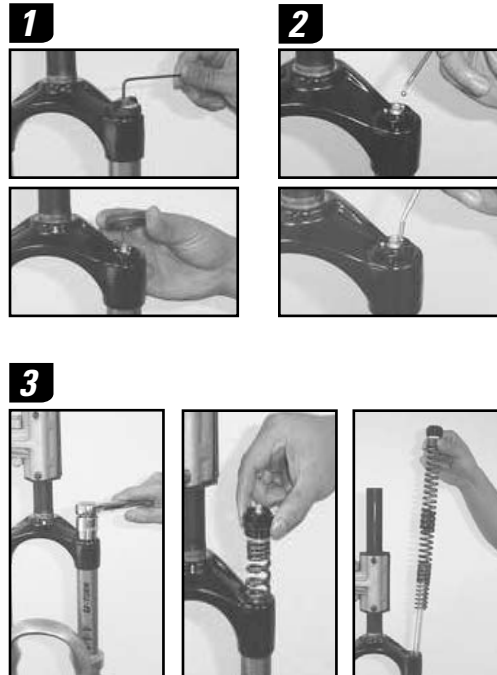

COIL U-TURN SPRING INSTALLATION INSTRUCTIONS

5. Apply fresh grease liberally to the entire spring assembly, and top cap threads.
6. Insert the U-Turn spring assembly into the upper tube, shaft end first. Align and seat the spring shaft through the shaft guide/base plate.
7. Insert the top cap into upper tube/crown and hand thread it into the upper tube. Use a 24 mm socket wrench to tighten to 65 in-lb.
8. Place the adjuster detent springs into the top cap detent holes, evenly spaced. Place a detent ball bearing on top of each detent spring.
Important: Make sure you use all three springs and bearings, otherwise the knob can turn and change travel on its own.
9. Place the U-Turn adjuster knob on top of hex-shaped adjuster. Tighten the U-Turn adjuster knob screw with a 2.5 mm hex wrench to 12 in-lb.

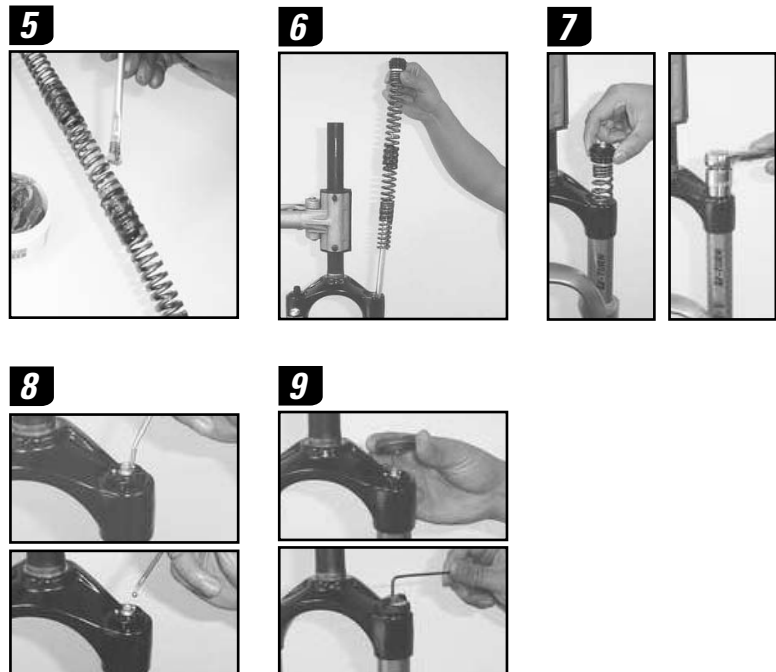

This concludes the spring service for your fork. You did a great job! You are now ready to move on to the next section: Lower Leg Installation.

SOLO AIR SPRING SERVICE

(ARGYLE 409 - TORA XC, SL, 318)

INTRODUCTION

At this point you should already have the lower legs removed from your fork. If not, you will need to return to the Lower Leg Removal section of this manual and follow the instructions for removing your fork lower legs.

SOLO AIR SPRING REMOVAL/SERVICE INSTRUCTIONS

Warning: Verify all pressure is removed from the fork before proceeding. Depress the Schrader valve again to remove any remaining air pressure. Failure to do so can result in injury and/or damage to the fork.

1. Use a 24 mm socket wrench to unthread the air spring top cap. The air spring assembly is attached to the top cap. Pull and lift the entire air spring assembly from the upper tube.
2. Pull the top cap out of the air tube assembly and pour any oil from the air tube into an oil pan.
3. Remove the air shaft/piston assembly from the bottom of the air tube by pulling the shaft down and rocking it from side to side.
4. Spray isopropyl alcohol on the inside and outside of the upper tube and wipe it with a clean rag. Wrap a clean rag around a long dowel and insert it into the upper tube to clean inside the upper tube. Spray isopropyl alcohol on the inside and outside of the air tube and wipe it with a clean rag. Wrap a clean rag around a long dowel and insert it into the air tube to clean inside the air tube.
5. Use small external snap ring pliers to remove the air piston snap ring. Remove the air piston wavy spring washer and piston from the air shaft.
Important: Compress the snap ring just enough to disengage it from the air shaft. Over-extending the snap ring can permanently damage it and cause air spring assembly failure.
6. Use a pick to remove the air piston outer o-ring. Apply grease to the new o-ring and install it.
7. Use a pick to remove the face seal o-ring from the underside of the air piston. Use isopropyl alcohol and a clean rag to clean the o-ring groove. Install the new o-ring into the groove then apply a few drops of Pit-Stop suspension oil to the o-ring.
Note: Pierce into the face seal o-ring with the pick and pull to remove it. Do not scoop or dig the o-ring out as this may damage the piston sealing surface.

1



2



3



5



6



7

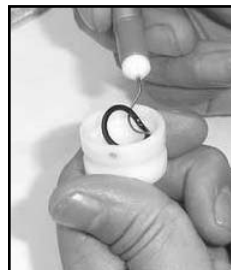

SOLO AIR SPRING REMOVAL/SERVICE INSTRUCTIONS (CONTINUED)

8. Install the air piston and spring wavy washer onto the air shaft and use small external snap ring pliers to secure the air piston snap ring in the snap ring groove. Check the snap ring fit to make sure it secures the air piston and wavy washer to the air shaft head. The air piston should compress upward slightly with spring resistance from wavy spring washer and snap ring.

Important: Compress the snap ring just enough to re-install it onto the air shaft. Over-extending the snap ring can permanently damage it and cause air spring assembly failure.

9. Slide the air sleeve/negative piston assembly from the air shaft. Spray the air shaft with isopropyl alcohol and wipe it with a clean rag.
10. Remove the top-out bumper and kick plate from the air sleeve/negative piston.
11. Use a pick to remove the inner and outer negative piston o-rings. Apply grease to the new o-rings and install them.

Important: When using a pick to remove o-rings, do not scratch the negative piston. Scratches may cause oil to leak.

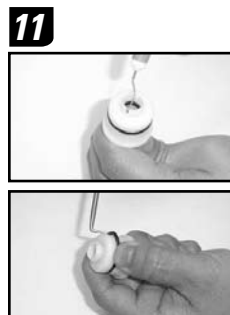
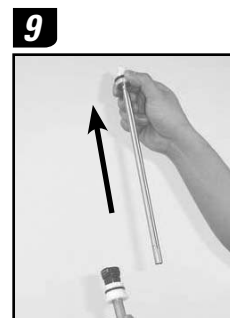

OPTIONAL - ALL TRAVEL CONFIGURATIONS

All Travel spacers are located above the top out bumper (Argyle and Tora XC/SL) or between the negative piston and the base plate (Tora 318). If you want to change the travel of your fork, add a spacer to decrease travel, or remove the spacer to increase travel.

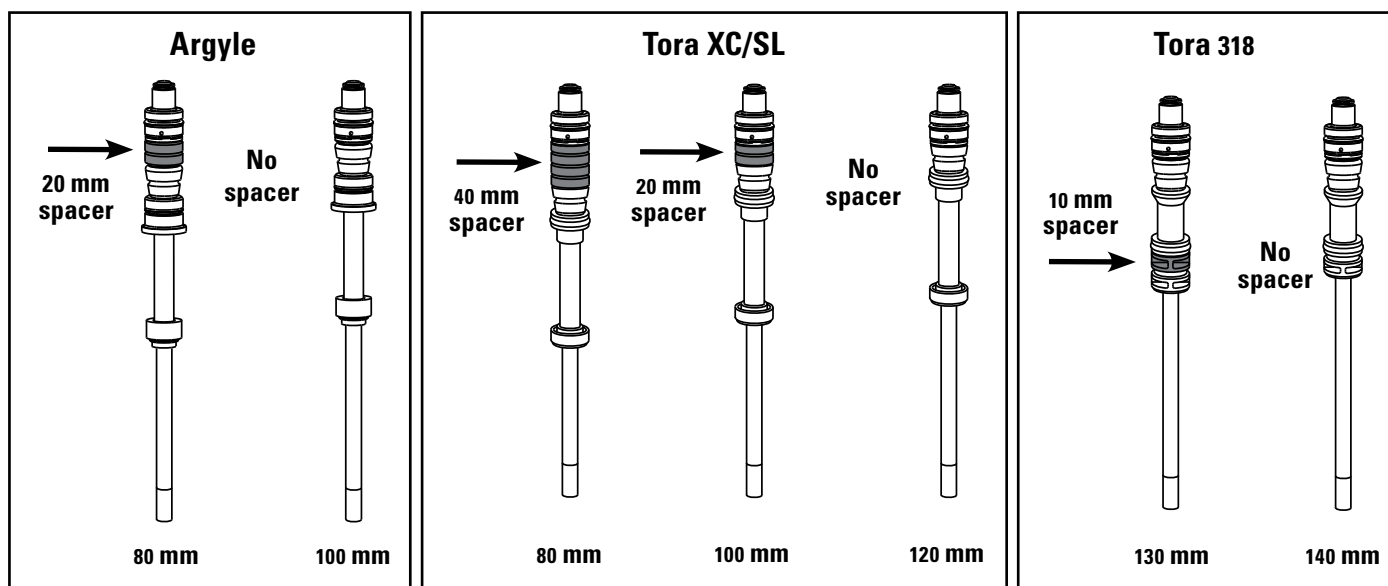

SOLO AIR SPRING INSTALLATION INSTRUCTIONS

12. Insert the top-out bumper and kick plate back onto the negative piston. Re-install the negative piston/sleeve assembly onto the air shaft, with the kick plate oriented toward the air piston.
13. Apply grease to the air assembly outer o-rings. Insert the air assembly into one end of the air tube. Push the negative piston into the air tube until it is firmly seated.
14. Insert the air top cap into the air tube and press it tight into the air tube.
15. Insert the air assembly, shaft first, into the upper tube from the top. Guide the bottom of the air shaft through the shaft guide in the bottom of the upper tube. Check the bottom of upper the tube and make sure the air shaft guide is seated into the upper tube shaft guide.
16. Apply a small amount of grease to the top cap threads and o-ring. Hand thread the top cap into the upper tube. Be careful not to damage the top cap o-ring upon installation.
17. Use a 24 mm socket wrench to tighten the top cap to 7.3 N-m (65 in-lb).

12

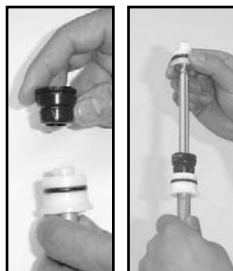

13

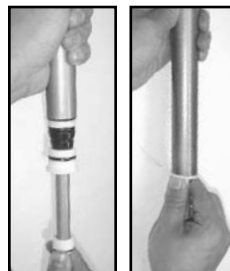

14

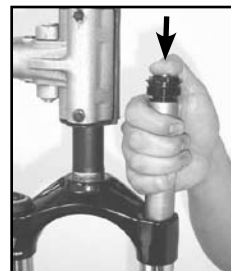

15



17

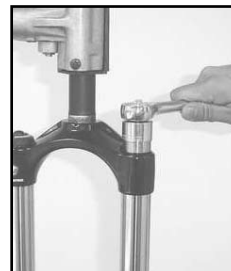

This concludes the spring service for your fork. You did a great job! You are now ready to move on to the next section: Lower Leg Installation.

SOLO AIR SPRING SERVICE

(RECON 327, 335, 351)

INTRODUCTION

At this point you should already have the lower legs removed from your fork. If not, you will need to return to the Lower Leg Removal section of this manual and follow the instructions for removing your fork lower legs.

SOLO AIR SPRING REMOVAL/SERVICE INSTRUCTIONS

Warning: Verify all pressure is removed from the fork before proceeding. Depress the Schrader valve again to remove any remaining air pressure. Failure to do so can result in injury and/or damage to the fork.

1. Unthread and remove the air spring top cap with a 24 mm socket wrench. Remove the fork from the stand and pour any oil from the air tube into an oil pan.
2. Clamp the fork back into the bicycle stand. Place the tips of large internal snap ring pliers in two of the ports in the base plate. Use the snap ring pliers to firmly press the bottom of the base plate into the upper tube and rotate until the base plate tab is behind the snap ring, out of the way of the snap ring eyelets.

3. Use large internal snap ring pliers to remove the snap ring. Guide the snap ring off of the spring shaft by hand.

Important: Do not scratch the air spring shaft surface while removing the snap ring. Scratches on the air spring shaft will allow air to bypass the seal head into the lower legs, resulting in reduced spring performance.

4. Firmly pull on the air shaft to remove the air spring assembly from the upper tube. Clean and inspect the assembly for damage.
5. Spray isopropyl alcohol on the inside and outside of the upper tube. Wipe the outside of the upper tube with a clean rag. Wrap a clean rag around a long dowel and insert it into the upper tube to clean inside the upper tube.
6. Slide the base plate, wavy washer, aluminum support washer, negative piston top out bumper, travel spacer (if applicable), negative piston, top out bumper, and kick plate from the air shaft. Spray the air shaft with isopropyl alcohol and wipe clean with a rag.

1



2

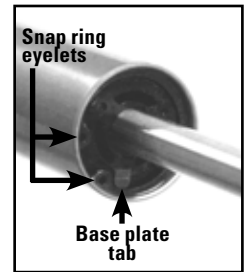
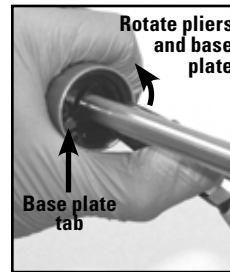

3

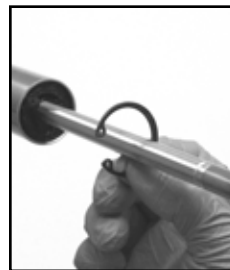

4



6

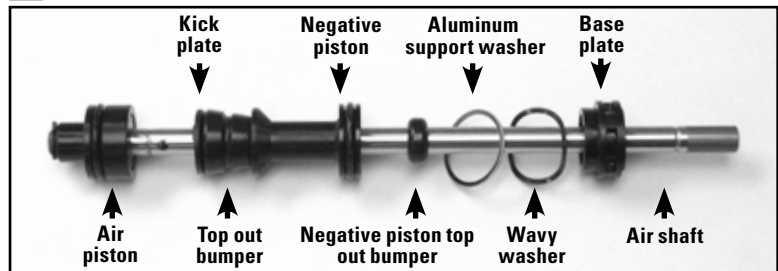

SOLO AIR SPRING REMOVAL/SERVICE INSTRUCTIONS (CONTINUED)

7. Use small external snap ring pliers to remove the air piston snap ring. Remove the spring wavy washer and air piston from the air shaft.

Important: Compress the snap ring just enough to disengage it from the air shaft.

Over-extending the snap ring can permanently damage it and cause air spring assembly failure.

8. Use a pick to remove the face seal o-ring from the underside of the air piston. Use isopropyl alcohol and a clean rag to clean the o-ring groove. Install the new o-ring into the groove then apply a few drops of Pit-Stop suspension oil to the o-ring.

Note: Pierce into the face seal o-ring with the pick and pull to remove it. Do not scoop or dig the o-ring out as this may damage the piston sealing surface.

9. Install the air piston and spring wavy washer onto the air shaft and use small external snap ring pliers to secure the air piston snap ring in the snap ring groove. Check the snap ring fit to make sure it secures the air piston and wavy washer to the air shaft head. The air piston should compress upward slightly with spring resistance from piston spring and snap ring.

Important: Compress the snap ring just enough to re-install it onto the air shaft. Over-extending the snap ring can permanently damage it and cause air spring assembly failure.

10. Use a pick to remove the air piston outer o-ring. Apply grease to the new o-ring and install it.

11. Use a pick to remove the inner and outer negative piston o-rings. Apply grease to the new o-rings and install them.

Important: When using a pick to remove o-rings, do not scratch the negative piston. Scratches may cause air to leak.

7



8



9

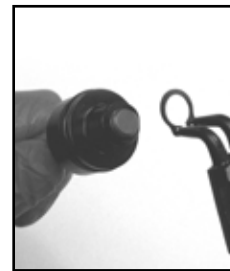

10



11



OPTIONAL - ALL TRAVEL CONFIGURATION

The All Travel spacer is located between the base plate and negative piston. If you want to change the travel of your fork, install the travel spacer to decrease travel, or remove the spacer to increase travel.

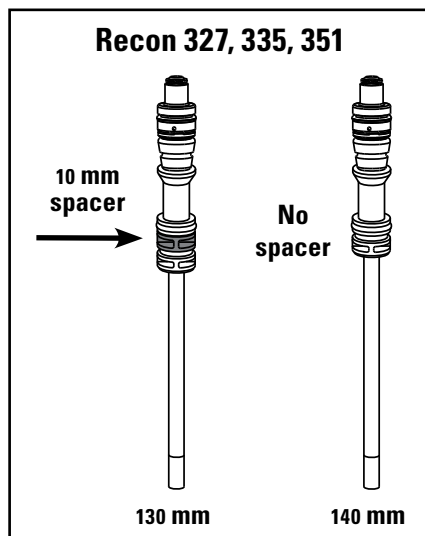

SOLO AIR SPRING INSTALLATION INSTRUCTIONS

12. Re-install the kick plate, top out bumper, and negative piston onto the air shaft with the kick plate oriented toward the air piston. Re-install the travel spacer (if applicable), negative piston top out bumper, aluminum support washer, wavy washer, and base plate onto the air shaft with the small diameter side of the base plate oriented toward the negative piston.

Note: If the aluminum support washer and wavy washer are separated from the base plate, install the wavy washer onto the base plate first, followed by the aluminum support washer.

13. Apply grease to the air assembly outer o-rings. Insert the air assembly into the bottom of the upper tube by gently rocking the air shaft side to side while firmly pushing it into the upper tube.

14. Install the snap ring onto large internal snap ring pliers. Use the pliers to push the base plate into the upper tube while installing the snap ring into its groove. The base plate tab should be situated between the snap ring eyelets.

Important: Make sure the snap ring is securely fastened in the snap ring groove. You can check this by using the snap ring pliers to rotate the snap ring back and forth a couple of times, then firmly pulling down on the air shaft.

Note: Snap rings have a sharper-edged side and a rounder-edged side. Installing snap rings with the sharper-edged side facing the tool will allow for easier installation and removal.

15. Use isopropyl alcohol and a clean rag to clean the top cap, then apply a small amount of grease to the top cap threads and o-ring. Insert the top cap into the upper tube/crown and hand thread it into the upper tube. Be careful not to damage the top cap o-ring upon installation.
16. Use a 24 mm socket wrench to tighten the top cap to 7.3 N·m (65 in·lb).

This concludes the spring service for your fork. You did a great job! You are now ready to move on to the next section: Lower Leg Installation.

13

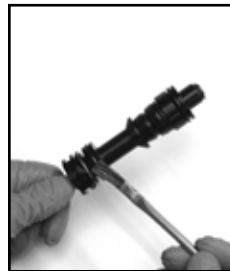

14



15



16



SOLO AIR SPRING SERVICE

(RECON XC, SL)

INTRODUCTION

At this point you should already have the lower legs removed from your fork. If not, you will need to return to the Lower Leg Removal section of this manual and follow the instructions for removing your fork lower legs.

SOLO AIR SPRING REMOVAL/SERVICE INSTRUCTIONS

Warning: Verify all pressure is removed from the fork before proceeding. Depress the Schrader valve again to remove any remaining air pressure. Failure to do so can result in injury and/or damage to the fork.

1. Unthread and remove the air spring top cap with a 24 mm socket wrench. Remove the fork from the stand and pour any air seal lubricant into an oil pan.
2. Clamp the fork back into the bicycle stand. Use your finger to press the air seal head into the upper tube. You will feel it break free and slide into the tube about 3 mm.

3. Use large internal snap ring pliers to remove the snap ring. Guide the snap ring off of the spring shaft by hand.

Important: Do not scratch the air spring shaft surface while removing the snap ring. Scratches on the air spring shaft will allow air to bypass the seal head into the lower legs, resulting in reduced spring performance.

4. Firmly pull down on the air shaft to remove the air spring assembly from the upper tube. Clean and inspect the assembly for damage.
5. Spray isopropyl alcohol on the inside and outside of the upper tube. Wipe the outside of the upper tube with a clean rag. Wrap a clean rag around a long dowel and insert it into the upper tube to clean inside the upper tube.
6. Use small external snap ring pliers to remove the air piston snap ring. Remove the air piston wavy spring washer, cushion, and air piston from the air shaft.

Important: Compress the snap ring just enough to disengage it from the air shaft. Over-extending the snap ring can permanently damage it and cause air spring assembly failure.

7. Use a pick to remove the air piston outer o-ring. Apply grease to the new o-ring and install it.

1

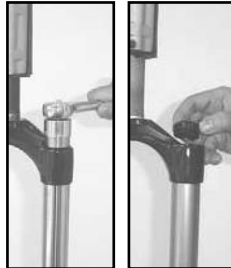

2



3

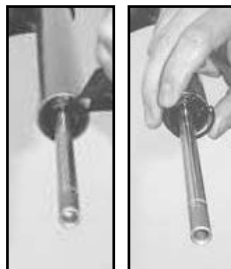

4

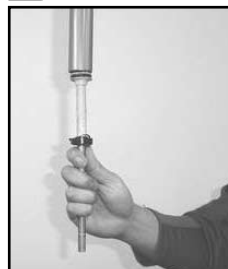

6



7



SOLO AIR SPRING REMOVAL/SERVICE INSTRUCTIONS (CONTINUED)

8. Use a pick to remove the face seal o-ring from the underside of the air piston. Use isopropyl alcohol and a clean rag to clean the o-ring groove. Install the new o-ring into the groove then apply a few drops of Pit-Stop suspension oil to the o-ring.

Note: Pierce into the face seal o-ring with the pick and pull to remove it. Do not scoop or dig the o-ring out as this may damage the piston sealing surface.



9. Install the air piston, cushion, and spring wavy washer onto the air shaft and use small external snap ring pliers to secure the air piston snap ring in the snap ring groove. Check the snap ring fit to make sure it secures the air piston and wavy washer to the air shaft head. The air piston should compress upward slightly with spring resistance from wavy spring washer and snap ring.

Important: Compress the snap ring just enough to re-install it onto the air shaft. Over-extending the snap ring can permanently damage it and cause air spring assembly failure.

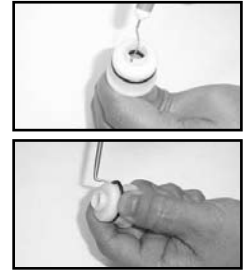
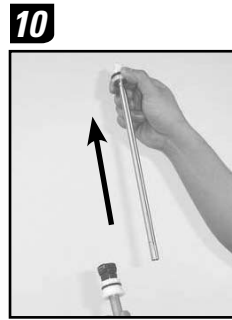

10. Slide the base plate, wavy washer, aluminum support washer, negative piston top out bumper, negative piston, top out bumper, and kick plate from the air shaft. Spray the air shaft with isopropyl alcohol and wipe clean with a rag.

11. Remove the top out bumper from the negative piston. Use a pick to remove the inner and outer negative piston o-rings. Apply grease to the new o-rings and install them.

Important: When using a pick to remove o-rings, do not scratch the negative piston. Scratches may cause air to leak.

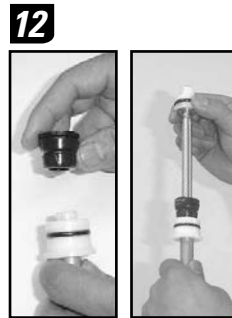

12. Insert the top-out bumper and kick plate back onto the negative piston. Re-install the negative piston/sleeve assembly onto the air shaft, with the kick plate oriented toward the air piston.

13. Apply grease to the air assembly outer o-rings. Insert the air assembly into the bottom of the upper tube by gently rocking the air shaft side to side while firmly pushing it into the upper tube. Check to make sure that the aluminum support washer rests evenly against the step inside the bottom of the upper tube, followed by the wavy washer.

OPTIONAL - ALL TRAVEL CONFIGURATION (RECON XC/SL)

All Travel spacers are located just above the top out bumper. If you want to change the travel of your fork, install the travel spacer to decrease travel, or remove the spacer to increase travel.

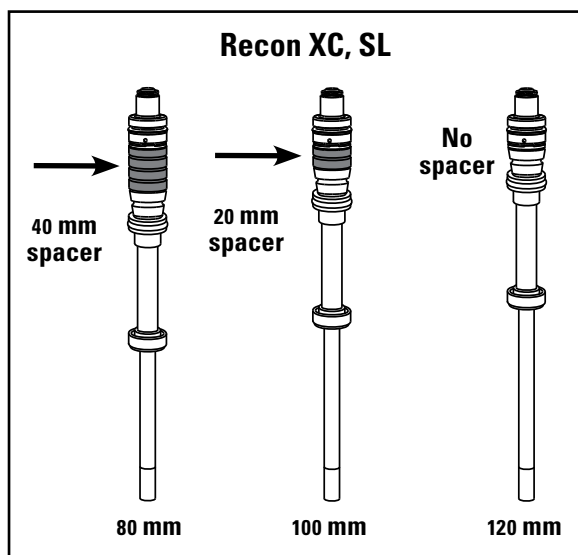

SOLO AIR SPRING INSTALLATION INSTRUCTIONS

14. Use your thumb to press the base plate into the upper tube until the snap ring groove is visible. Use large snap ring pliers to secure the snap ring in its groove. Position the snap ring eyelets on either side of the base plate tab.

14

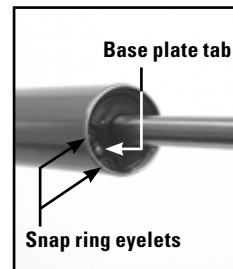

Important: Make sure the snap ring is securely fastened in the snap ring groove. You can check this by using the snap ring pliers to rotate the snap ring back and forth a couple of times, then firmly pulling down on the air shaft.

Note: Snap rings have a sharper-edged side and a rounder-edged side. Installing snap rings with the sharper-edged side facing the tool will allow for easier installation and removal.

15. Use isopropyl alcohol and a clean rag to clean the top cap, then apply a small amount of grease to the top cap threads and o-ring. Insert the top cap into the upper tube/crown and hand thread it into the upper tube. Be careful not to damage the top cap o-ring upon installation.
16. Use a 24 mm socket wrench to tighten the top cap to 7.3 N·m (65 in-lb).

15



16



This concludes the spring service for your fork. You did a great job! You are now ready to move on to the next section: Lower Leg Installation.

SOLO AIR SPRING SERVICE

(LYRIK IS, R - TOTEM)

INTRODUCTION

At this point you should already have the lower legs removed from your fork. If not, you will need to return to the Lower Leg Removal section of this manual and follow the instructions for removing your fork lower legs.

SOLO AIR SPRING REMOVAL/SERVICE INSTRUCTIONS

Warning: Verify all pressure is removed from the fork before proceeding. Depress the Schrader valve again to remove any remaining air pressure. Failure to do so can result in injury and/or damage to the fork.

1. Unthread and remove the air spring top cap with a 24 mm socket wrench. Remove the fork from the stand and pour any air seal lubricant into an oil pan.
2. Clamp the fork back into the bicycle stand. Place the tips of large internal snap ring pliers in two of the ports in the base plate. Use the snap ring pliers to firmly press the bottom of the base plate into the upper tube and rotate until the base plate tab is behind the snap ring, out of the way of the snap ring eyelets.

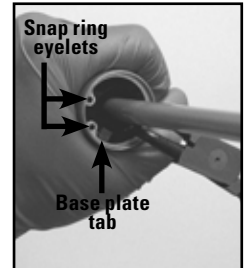
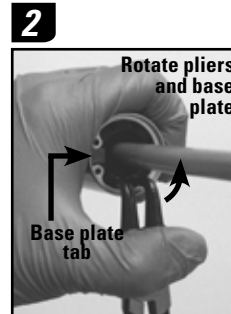

3. Use large internal snap ring pliers to remove the snap ring. Guide the snap ring off of the spring shaft by hand.

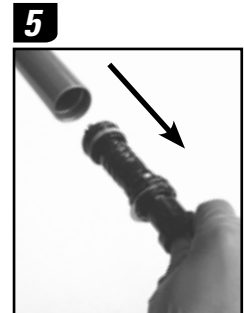
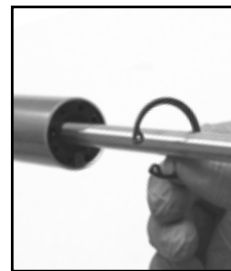

Important: Do not scratch the air spring shaft surface while removing the snap ring. Scratches on the air spring shaft will allow air to bypass the seal head into the lower legs, resulting in reduced spring performance.

4. Firmly pull on the air shaft to remove the air spring assembly from the upper tube. Clean and inspect the assembly for damage.
5. Spray isopropyl alcohol on the inside and outside of the upper tube. Wipe the outside of the upper tube with a clean rag. Wrap a clean rag around a long dowel and insert it into the upper tube to clean inside the upper tube.

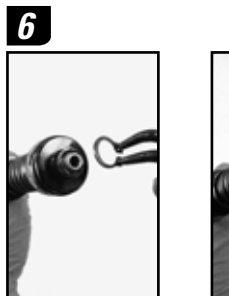

6. Use small external snap ring pliers to remove the air piston snap ring. Remove the air piston wavy spring washer, cushion, and air piston from the air shaft.

Important: Compress the snap ring just enough to disengage it from the air shaft.

Over-extending the snap ring can permanently damage it and cause air spring assembly failure.

SOLO AIR SPRING REMOVAL/SERVICE INSTRUCTIONS (CONTINUED)

7. Use a pick to remove the air piston outer o-ring and foam ring. Install the new o-ring and a new foam ring onto the air piston. Apply grease the new o-ring then saturate the new foam ring with Pit-Stop suspension oil.

7



8. Use a pick to remove the face seal o-ring from the underside of the air piston. Use isopropyl alcohol and a clean rag to clean the o-ring groove. Install the new o-ring into the groove then apply grease to the o-ring.

Note: Pierce into the face seal o-ring with the pick and pull to remove it. Do not scoop or dig the o-ring out as this may damage the piston sealing surface.

8



9. Install the air piston, cushion, and spring wavy washer onto the air shaft and use small external snap ring pliers to secure the air piston snap ring in the snap ring groove. Check the snap ring fit to make sure it secures the air piston and wavy washer to the air shaft head. The air piston should compress upward slightly with spring resistance from wavy spring washer and snap ring.

9

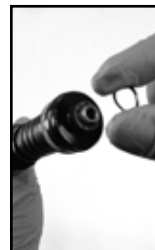

Important: Compress the snap ring just enough to re-install it onto the air shaft. Over-extending the snap ring can permanently damage it and cause air spring assembly failure.

10. Slide the base plate, wavy washer, aluminum support washer, negative piston top out bumper, negative piston, top out bumper, and kick plate from the air shaft. Spray the air shaft with isopropyl alcohol and wipe clean with a rag.

10

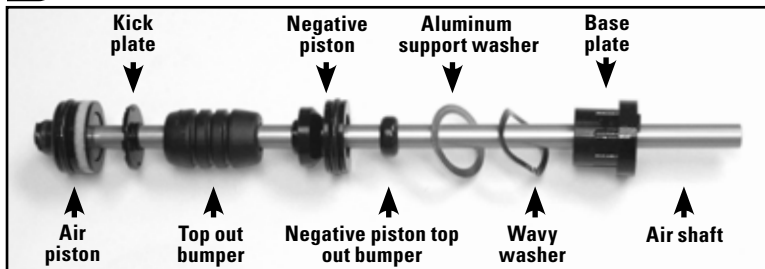

11. Remove the top out bumper from the negative piston. Use a pick to remove the inner and outer negative piston o-rings. Apply grease to the new o-rings and install them.

11



12



Important: When using a pick to remove o-rings, do not scratch the negative piston. Scratches may cause air to leak.

12. Insert the top-out bumper and kick plate back onto the negative piston. Re-install the negative piston/sleeve assembly onto the air shaft, with the kick plate oriented toward the air piston.

13. Re-install the negative piston top out bumper, aluminum support washer, wavy washer, and base plate onto the air shaft with the small diameter side of the base plate oriented toward the negative piston.

13



14



Note: If the aluminum support washer and wavy washer are separated from the base plate, install the wavy washer onto the base plate first, followed by the aluminum support washer.

14. Apply grease to the air assembly outer o-rings. Insert the air assembly into the bottom of the upper tube by gently rocking the air shaft side to side while firmly pushing it into the upper tube.

OPTIONAL - ALL TRAVEL CONFIGURATION (LYRIK)

The All Travel spacer is located between the base plate and negative piston. If you want to change the travel of your fork, install the travel spacer to decrease travel, or remove the spacer to increase travel.

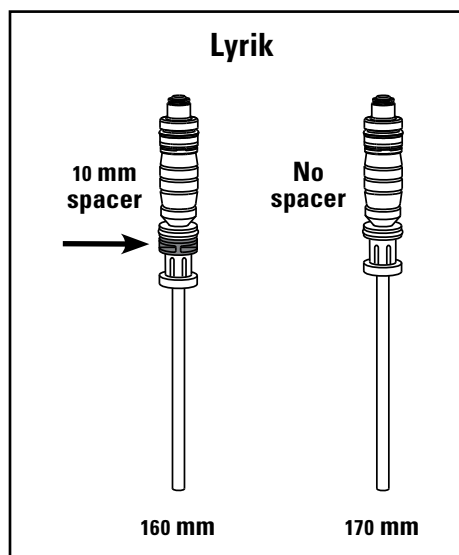

SOLO AIR SPRING INSTALLATION INSTRUCTIONS

15. Install the snap ring onto large internal snap ring pliers. Use the pliers to push the base plate into the upper tube while installing the snap ring into its groove. The base plate tab should be situated between the snap ring eyelets.

Important: Make sure the snap ring is securely fastened in the snap ring groove. You can check this by using the snap ring pliers to rotate the snap ring back and forth a couple of times, then firmly pulling down on the air shaft.

Note: Snap rings have a sharper-edged side and a rounder-edged side. Installing snap rings with the sharper-edged side facing the tool will allow for easier installation and removal.

16. Use isopropyl alcohol and a clean rag to clean the top cap, then apply a small amount of grease to the top cap threads and o-ring. Insert the top cap into the upper tube/crown and hand thread it into the upper tube. Be careful not to damage the top cap o-ring upon installation.

This concludes the spring service for your fork. You did a great job! You are now ready to move on to the next section: Lower Leg Installation.

15

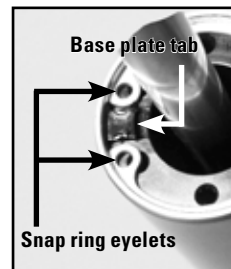
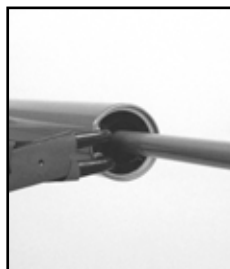

16



DUAL AIR SPRING SERVICE

(PIKE 409, 426, 454 - REBA SL, RACE, TEAM - REVELATION SL, RACE, TEAM - SID RACE, TEAM, WC)

INTRODUCTION

At this point you should already have the lower legs removed from your fork. If not, you will need to return to the Lower Leg Removal section of this manual and follow the instructions for removing your fork lower legs.

DUAL AIR SPRING REMOVAL/SERVICE INSTRUCTIONS

Warning: Verify all pressure is removed from the fork before proceeding. Depress the Schrader valve again to remove any remaining air pressure. Failure to do so can result in injury and/or damage to the fork.

1. Unthread and remove the air spring top cap with a 24 mm socket wrench. Remove the fork from the stand and pour any air seal lubricant into an oil pan.
2. Clamp the fork back into the bicycle stand. Push the negative air shaft up and into base plate, leaving only the tip of the threaded shaft end protruding from base plate.

Note: You may need to depress the Schrader valve as you push the shaft, to prevent a vacuum.

3. Slide a 15 mm socket tool (or similar hollow tool) over the air shaft end and press firmly against the base plate. While pressing the air base plate up and into the upper tube, remove the snap ring using large external snap ring pliers.
4. Firmly pull the air shaft down to remove the air spring assembly from the upper tube.
5. Spray isopropyl alcohol on the inside and outside of the upper tube and wipe with a clean rag. Wrap a clean rag around a long dowel and insert it into the upper tube to clean inside the upper tube.
6. Remove the base plate, base plate bumper, and negative air piston from the Dual Air shaft.
Reba only: Remove the base plate, wavy washer, flat washer, base plate bumper, and negative air piston from the Dual Air shaft.

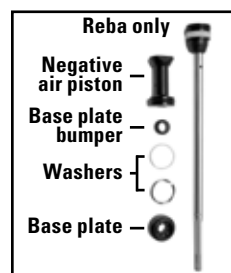
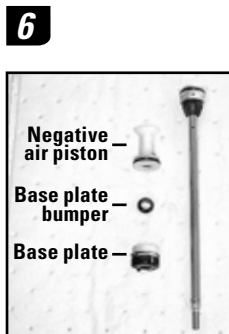
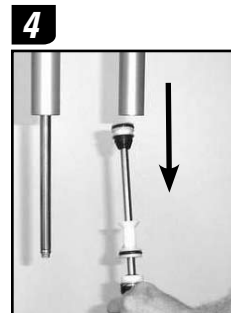
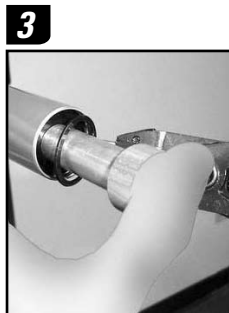
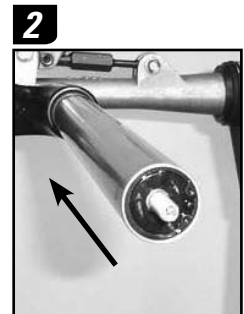
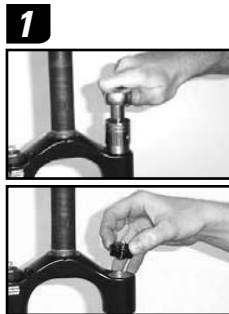

DUAL AIR SPRING REMOVAL/SERVICE INSTRUCTIONS (CONTINUED)

7. Use a pick to remove the inner and outer negative piston o-rings. Apply grease to the new o-rings and install.

Important: When using a pick to remove o-rings, do not scratch the negative piston. Scratches may cause air to leak.

8. Use a pick to remove the air piston o-ring. Apply grease to the new o-ring and install it.

Reba only: Use a pick to remove the foam ring from the air piston. Soak the new foam ring in 15wt Pitstop suspension oil, then install it onto the piston.

Important: When using a pick to remove the o-ring, do not scratch the air piston. Scratches may cause air to leak.

7

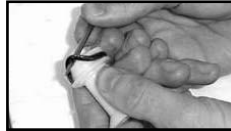

8

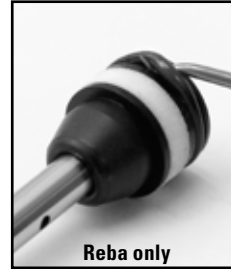

OPTIONAL - ALL TRAVEL CONFIGURATIONS

All Travel spacers are located just above the top out bumper washer (SID/Revelation/Pike) or between the base plate and negative piston (Reba). If you want to change the travel of your fork, install the travel spacer(s) onto the Dual Air shaft to decrease travel, or remove to increase travel.

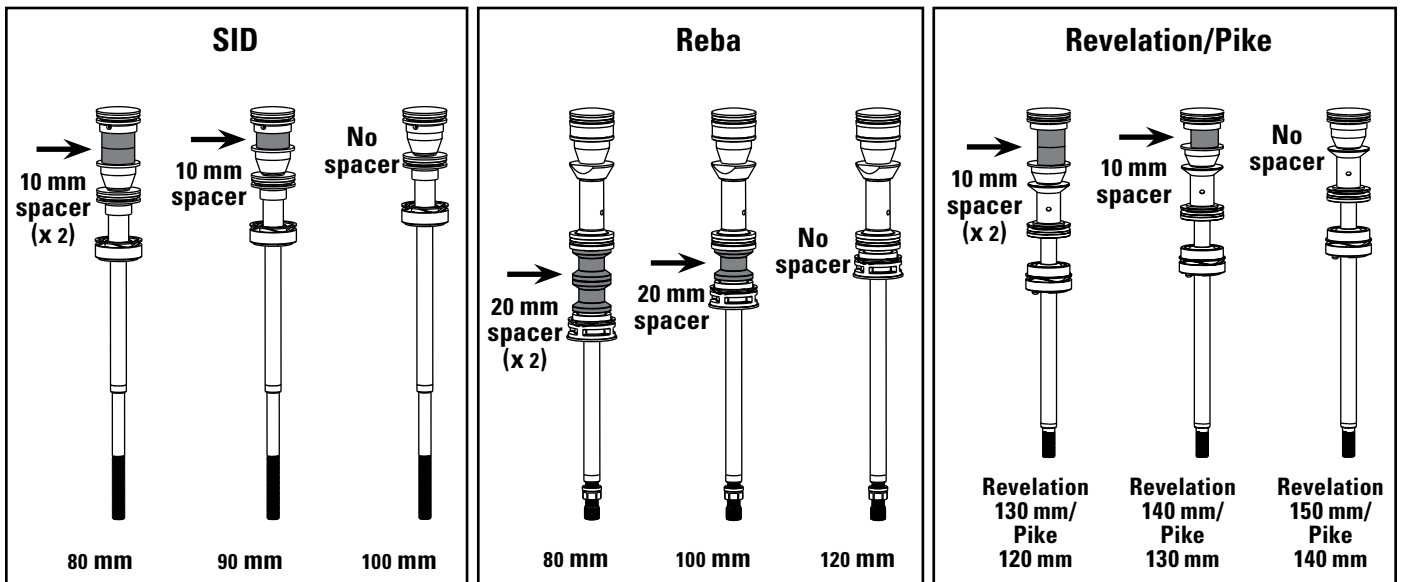

DUAL AIR SPRING INSTALLATION INSTRUCTIONS

9. Re-install the negative piston, base plate bumper and base plate onto the Dual Air shaft and re-apply grease to the o-rings.

Reba/Revelation only: Re-install the negative piston, base plate bumper, flat washer, wavy washer, and base plate onto the Dual Air shaft. Re-apply grease to the o-rings.

10. Insert the Dual Air assembly into the upper tube, air piston first, followed by the negative piston and base plate assembly.

11. Use your thumb to press the base plate into the upper tube until the snap ring groove is visible. Use large snap ring pliers to secure the snap ring in its groove. Position the snap ring eyelets on either side of the base plate tab.

Important: Make sure the snap ring is securely fastened in the snap ring groove. You can check this by using the snap ring pliers to rotate the snap ring back and forth a couple of times, then firmly pulling down on the air shaft.

Note: Snap rings have a sharper-edged side and a rounder-edged side. Installing snap rings with the sharper-edged side facing the tool will allow for easier installation and removal.

12. Use isopropyl alcohol and a clean rag to clean the top cap, then apply a small amount of grease to the top cap threads and o-ring. Insert the top cap into the upper tube/crown and hand thread it into the upper tube. Be careful not to damage the top cap o-ring upon installation.
13. Use a 24 mm socket wrench to tighten the top cap to 7.3 N·m (65 in-lb).

This concludes the spring service for your fork. You did a great job! You are now ready to move on to the next section: Lower Leg Installation.

9



10

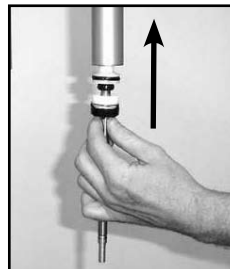

Reba/Revelation only

11



12



13



AIR U-TURN SPRING SERVICE

(PIKE 409, 429, 454 - REBA RACE, TEAM - REVELATION SL, RACE, TEAM)

INTRODUCTION

At this point you should already have the lower legs removed from your fork. If not, you will need to return to the Lower Leg Removal section of this manual and follow the instructions for removing your fork lower legs.

AIR U-TURN SPRING REMOVAL/SERVICE INSTRUCTIONS

Warning: Verify all pressure is removed from the fork before proceeding. Depress the Schrader valve again to remove any remaining air pressure. Failure to do so can result in injury and/or damage to the fork.

1. Apply downward pressure to the Air U-Turn adjuster knob and use a pick or flat bladed screwdriver to push/pull the knob retaining clip off of the air valve body. Remove the adjuster knob.
2. Use a magnet to remove the detent ball bearings and detent springs from the top cap.
3. Use a 24 mm socket wrench to loosen and unthread the top cap. Remove the top cap and the entire air assembly from the top of the fork.
4. **Revelation only:** Use your finger to push in on the base plate at the bottom of the non-drive side upper tube. Use large internal snap ring pliers to remove the base plate snap ring. Use a long dowel to remove the base plate from the upper tube. Use a pick to remove the inner and outer base plate o-rings. Apply grease to the new o-rings and install them. Re-install the base plate into the upper tube. Use large snap ring pliers to re-install the snap ring. Be sure to align the base plate tab between the snap ring eyelets. Apply a generous amount of grease to the base plate inner o-ring.
Important: When using a pick to remove o-rings, do not scratch the base plate. Scratches may cause air to leak.
5. Unthread the top cap from the top of the air assembly. Use a pick to remove the plastic washer from inside of the top cap or from the top of the travel adjustment shaft. Set the washer aside.
6. Use a pick to remove the top cap o-ring
Revelation only: Remove both top cap o-rings. Apply grease to the new o-ring(s) and install.
Important: When using a pick to remove o-rings, do not scratch the top cap. Scratches may cause air to leak.

1



2



3

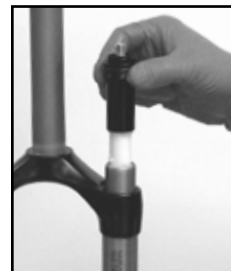

4

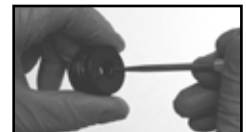

5

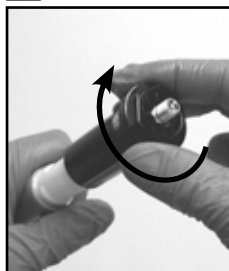

AIR U-TURN SPRING REMOVAL/SERVICE INSTRUCTIONS (CONTINUED)

7. Use small external snap ring pliers to remove the small external snap ring located at the bottom of the air assembly, then remove the negative piston retention plate.

Important: Compress the snap ring just enough to remove it from its groove. Over-extending the snap ring can permanently damage it and cause air spring assembly failure.

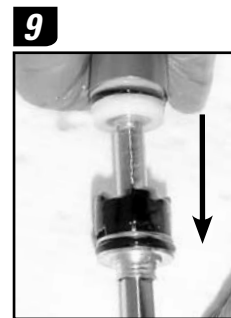

8. Use large internal snap ring pliers to remove the snap ring from the bottom of the air tube. Use the tips of the pliers to press the aluminum negative piston slightly into the air tube while engaging the snap ring for a more secure snap ring engagement. Remove the snap ring by guiding it off of the air shaft by hand.

Important: Do not scratch the air spring shaft surface while removing the snap ring. Scratches on the air spring shaft will allow air to bypass the seal head into the lower legs, resulting in reduced spring performance.

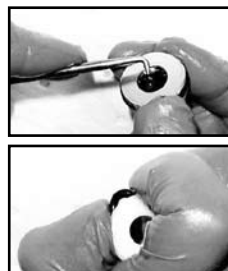
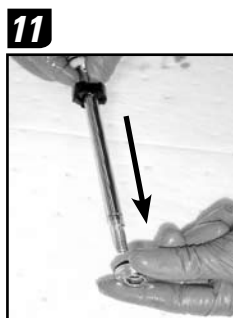

9. Pull the air shaft, negative piston and air piston assembly out of the air tube.
10. Spray isopropyl alcohol on the air shaft and wipe it with a clean rag.

11. Slide the aluminum negative piston and top out bumper from the air shaft. Use a pick to remove the inner and outer negative piston o-rings. Apply grease to the new o-rings and install them.
Important: When using a pick to remove o-rings, do not scratch the negative piston. Scratches may cause air to leak.

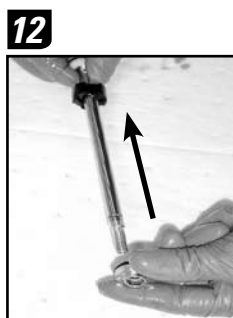

12. Re-install the top out bumper and negative piston onto the air shaft with the flat side of the negative piston oriented toward the air piston.
13. Use a pick to remove the air piston o-ring. Apply grease to the new o-ring and install it.
Important: When using a pick to remove o-rings, do not scratch the piston. Scratches may cause air to leak.

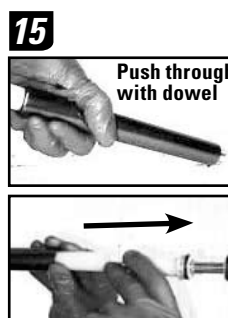
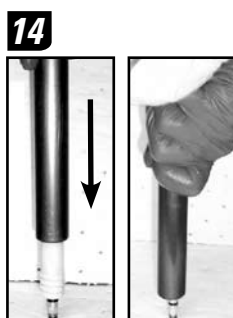

Revelation only: Skip to step 23.

14. Place the bottom of the air tube against a sturdy, flat working surface. Use a plastic mallet to lightly tap the air valve body multiple times until you feel the choke assembly disengage from the air tube.

Note: The choke assembly will feel tight while disengaging from the air tube. Avoid tapping firmly against the valve body as this may cause damage. Multiple light taps will disengage the choke assembly without damaging any parts.

15. Use a dowel to continue to push the choke assembly through and out of the air tube. Remove the choke assembly completely from air tube.

AIR U-TURN SPRING REMOVAL/SERVICE INSTRUCTIONS (CONTINUED)

16. Spray isopropyl alcohol on the inside and outside of the air tube and wipe with a clean rag. Wrap a clean rag around a long dowel and insert it into the air tube to clean inside the air tube.

17. Use small external snap ring pliers to remove the choke piston retaining ring from the travel adjustment shaft. Remove the choke piston and choke piston/shaft washer.

18. Remove the choke piston o-ring. Apply grease to the new o-ring and install.

Important: When using a pick to remove the o-ring, do not scratch the choke piston. Scratches may cause air to leak.

19. Remove the travel adjustment seal head from the travel adjustment shaft.

20. Use a pick to remove both the inner and outer seal head o-rings. Apply grease to the new o-rings and install.

Important: When using a pick to remove the o-ring, do not scratch the seal head. Scratches may cause air to leak.

21. Use a pick to remove the travel adjustment shaft o-ring. Apply grease to the new o-ring and install it.

Important: When using a pick to remove the o-ring, do not scratch the shaft. Scratches may cause air to leak.

22. Apply grease to the travel adjustment seal head inner o-ring. Re-install the travel adjustment seal head onto the travel adjustment shaft.

Important: Be sure the keys on the travel adjustment shaft are inserted into the narrower key slots in the travel adjustment seal head.

23. Install the choke piston/shaft washer and the choke piston onto the travel adjustment shaft. Use small external snap ring pliers to install a new snap ring onto the travel adjustment shaft.

24. Apply grease to both piston outer o-rings.

17



18



19



20

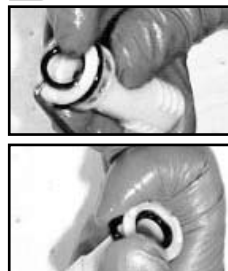

21



22



23



24

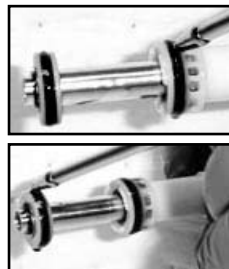

AIR U-TURN SPRING INSTALLATION INSTRUCTIONS

25. Apply a thin film of grease to the snap ring groove inside of the open end of the air spring tube. Insert the upper choke assembly into the open end of the air spring tube, air valve first, and press completely into the air tube.

25



26

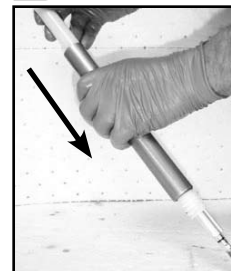

26. Using a long non-metallic dowel, push the choke assembly up into the air tube until it is seated flush against the inside of the rolled end of the air tube. Firmly pull on the choke assembly to ensure a secure fit against the inside of the air tube.

Note: You may need to guide the choke assembly through the opening at the rolled end of the air tube to prevent the choke assembly outer threads from getting caught on the air tube lip.

27

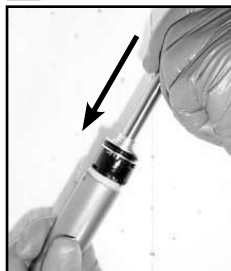

28



27. Apply grease to the air piston and negative piston outer o-rings. Insert the air piston into the open end of the air spring. Push the air shaft assembly into the air tube. Push the negative piston into the air tube until it is seated just past the snap ring groove.

28. Wipe any remaining grease from the snap ring groove with a clean rag. Use large internal snap ring pliers to secure the snap ring into its groove. **Important: Make sure the snap ring is securely fastened in the snap ring groove. You can check this by using the snap ring pliers to rotate the snap ring back and forth a couple of times, then firmly pulling down on the air shaft.**

29



30

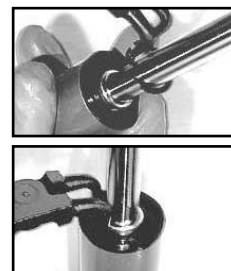

Note: Snap rings have a sharper-edged side and a rounder-edged side. Installing snap rings with the sharper-edged side facing the tool will allow for easier installation and removal.

29. Add air to the positive air chamber (40-60psi) to ensure that the air assembly components are seated properly inside the air tube.

30. Insert the negative piston retention plate into the end of air tube, stepped side first. Use small external snap ring pliers to re-install the retention plate snap ring.

Important: Compress the snap ring just enough to install it into its groove. Over-extending the snap ring can permanently damage it and cause air spring assembly failure.

Note: The U-Turn air assembly is now assembled and ready to be installed into fork upper tube/crown.

AIR U-TURN SPRING INSTALLATION INSTRUCTIONS (CONTINUED)

31. Place the plastic washer over the air valve and seat it against the top of the keys on the travel adjustment shaft. Apply grease to the travel adjustment seal head threads and shaft o-ring. Insert the Air U-Turn assembly into bottom of the non-drive side upper tube, choke assembly end first.

31

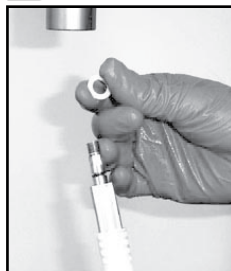

32. Thread the top cap onto the travel adjustment seal head until the Schrader valve is completely extended from the hole in the center of the top cap.

32

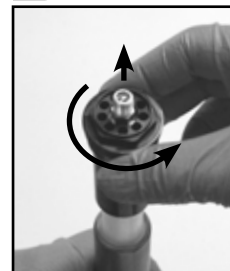

33. Apply a few drops of blue thread lock to the top cap outer threads. Use a 24 mm socket wrench to thread the top cap into the upper tube. Tighten it to 14.6 N-m (130 in-lb).

33



34. Place the detent springs into the top cap detent holes, leaving one empty hole between each spring (this will result in two springs located in two consecutive holes, the location of which is not critical). Place a detent ball bearing on top of each detent spring.

34



Important: Make sure you use all five springs and bearings, otherwise the knob can turn and change travel on its own.

35. Place the Air U-Turn adjuster knob on the hex-shaped shaft end. Press down on the adjuster knob to access the retaining ring groove below the valve body threads. While pressing down on the knob, use a flat bladed screwdriver to secure the knob retaining ring, from the side, onto the valve body. **Make sure retaining ring is inserted into the groove, not the air shaft threads.**

35



Important: The Air U-Turn fork must be set to full travel setting before installing the lower legs. Turn the Air U-Turn adjuster knob counter-clockwise to set the fork to full travel.

This concludes the spring service for your fork. You did a great job! You are now ready to move on to the next section: Lower Leg Installation.

2-STEP AIR SPRING SERVICE

(LYRIK - TOTEM)

INTRODUCTION

At this point you should already have the lower legs removed from your fork. If not, you will need to return to the Lower Leg Removal section of this manual and follow the instructions for removing your fork lower legs.

2-STEP AIR SPRING REMOVAL/SERVICE INSTRUCTIONS

1. Remove all air pressure from the system by depressing the air valve at the bottom of the left leg, and then remove the 2-Step Schrader valve using a Schrader valve tool.

Warning: Verify all pressure is removed from the fork before proceeding. Depress the Schrader valve again to remove any remaining air pressure. Failure to do so can result in injury and/or damage to the fork.

2. Use a 2 mm hex wrench to remove the 2-Step adjuster fixing screw and control knob.
3. Use a T10 TORX® wrench to remove the bleed screw from the top cap.
4. Use a 24 mm socket wrench to unthread the 2-Step top cap. Push up on the air shaft to extend the top of the air tube from the crown enough to grab onto the top cap and remove it from the air assembly.
5. Use a pick to remove the top cap o-rings. Apply a few drops of Pit-Stop suspension oil to the new o-ring and install it.
Important: When using a pick to remove the o-rings, do not scratch the top cap. Scratches may cause air/oil to leak.
6. Remove the fork from the bicycle stand and pour oil from the upper tube into an oil pan. Return the fork to the bicycle stand.
7. Push the spring shaft and air assembly into the upper tube, leaving just enough shaft exposed to hold onto with your fingers. Use large internal snap ring pliers to remove the retaining ring from the bottom of the non-drive side upper tube.
8. Gently pull on the air shaft to remove the entire 2-Step assembly.
9. Remove the lower seal head from the shaft assembly.

1



2



3



4

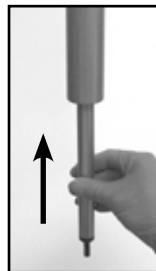

5



7



8

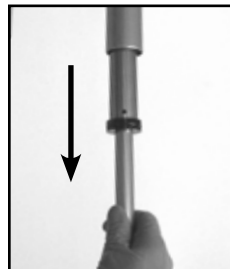

9



2-STEP AIR SPRING REMOVAL/SERVICE INSTRUCTIONS (CONTINUED)

Floating piston/housing service

10. Pull the floating piston housing off of the top of the air tube.
11. Push the floating piston out through the top of the floating piston housing. Use a pick to remove the floating piston housing o-ring. Clean the floating piston housing with isopropyl alcohol and inspect it for damage or scratches, paying close attention to the inside surface. If damaged or scratched, replace the floating piston housing. Apply a few drops of Pit-Stop suspension oil to the new floating piston housing o-ring and install it.

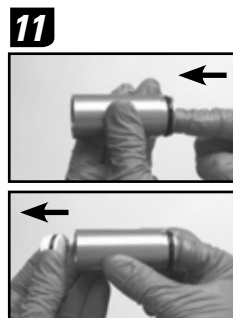

12. Use your fingers or a pick to remove the floating piston o-ring. Clean the floating piston with isopropyl alcohol. Apply a few drops of Pit-Stop suspension oil to the new o-ring and install.

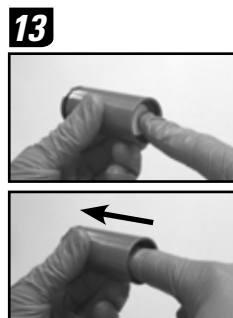
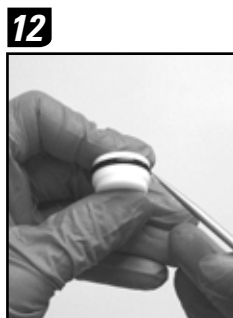

Important: When using a pick to remove the o-ring, do not scratch the floating piston housing. Scratches may cause air/oil to leak.

13. Lightly grease the floating piston o-ring and insert the floating piston into the floating piston housing, larger diameter side first. Push the floating piston into the floating piston housing until it stops.

Note: Improper installation of the floating piston will change the 2-Step air spring performance and/or affect the system's ability to achieve the full travel adjustment range.

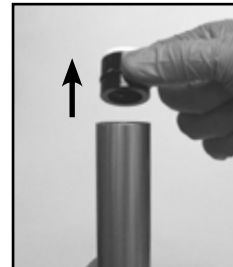
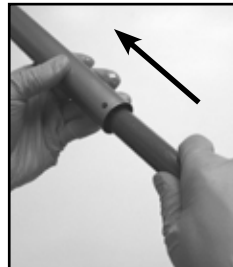

Air spring service

14. Push the air shaft/piston out of the air tube through the top, then use a long plastic or wooden dowel to push the negative piston/negative piston bumper out through the top of the air tube.

Important: Do not remove the spring shaft assembly from the bottom of the air tube.

Sliding the piston o-rings past the holes in the bottom of the air tube will damage the o-rings.

15. Spray isopropyl alcohol on the inside and outside of the air tube and wipe it with a clean rag. Wrap a clean rag around a long dowel and insert into the air tube to clean inside the air tube. Inspect the air tube for damage, scratches, and debris. Remove any debris. Replace the air tube if damaged or scratched.

2-STEP AIR SPRING REMOVAL/SERVICE INSTRUCTIONS (CONTINUED)

16. Remove the negative piston cushion (Lyrik) or quad ring (Totem), negative piston, and top out spring quad ring from the air shaft. Use a flat bladed screwdriver to separate the top out spring from the air piston by inserting the tip of the screwdriver into one of the slots just below the air piston, then prying the two pieces apart. Remove the top out spring from the air shaft.

Important: Separating the top out spring from the air piston will cause damage to the air piston. The damaged air piston will need to be replaced.

16

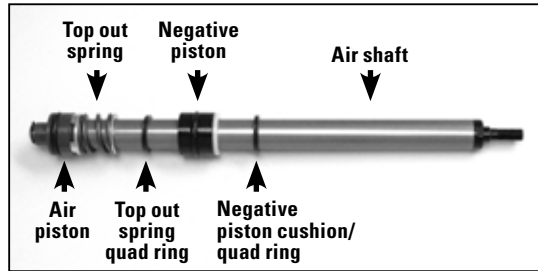

17. Use small external snap ring pliers to remove the air piston snap ring. Remove the air piston wavy spring washer and air piston from the air shaft.
Important: Compress the snap ring just enough to disengage it from the air shaft.

Over-extending the snap ring can permanently damage it and cause air spring assembly failure.

18. Spray the air shaft with isopropyl alcohol and wipe it with a clean rag. Inspect the air shaft for damage or scratches. Replace the air shaft if it is damaged or scratched.

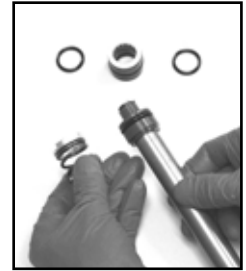
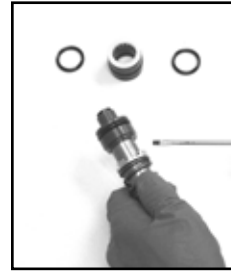

19. Replace the entire air piston. Install the new air piston and spring wavy washer onto the air shaft and use small external snap ring pliers to secure the air piston snap ring in the snap ring groove. Check the snap ring fit to make sure it secures the air piston and wavy washer to the air shaft head. The air piston should compress upward slightly with spring resistance from wavy spring washer and snap ring.

Important: Compress the snap ring just enough to re-install it onto the air shaft. Over-extending the snap ring can permanently damage it and cause air spring assembly failure.

17

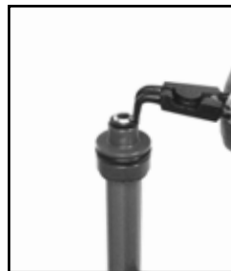

20. Slide the top out spring over the air shaft with the aluminum clip oriented toward the air piston. Reassemble the top out spring and air piston by firmly pressing the top out spring/piston retention clip onto the bottom of the air piston. Install the top out spring cushion (Lyrik) or quad ring (Totem) onto the air shaft against the top out spring.

20

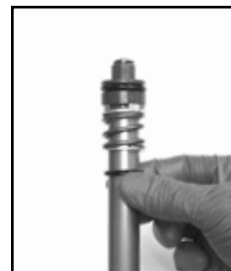
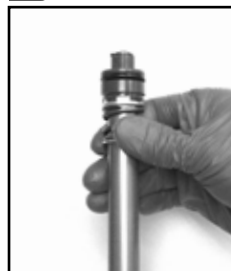

21. Replace the entire negative piston. Lightly grease the inner seals of the new negative piston. Install the negative piston onto the air shaft with the negative piston seal retention clip oriented **away** from the air piston/top out spring. Install the negative piston quad ring onto the air shaft against the negative piston.

21

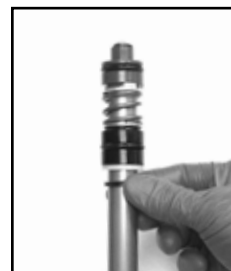

2-STEP AIR SPRING REMOVAL/SERVICE INSTRUCTIONS (CONTINUED)

22. Lightly grease the negative piston and air piston outer o-rings. Install the entire air spring assembly, air valve side first, into the air tube from the top of the tube (the side opposite the two holes in the tube). Push the air shaft assembly into the air tube until just the air valve portion of the air shaft extends from the bottom of the air tube.

22

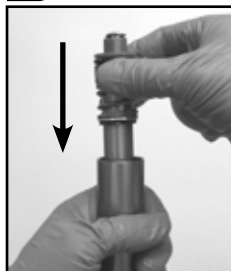

23. Replace the entire seal head. Lightly grease the inner seals of the new seal head. Install the seal head into the bottom of the air tube with the seal head seal retention clip positioned inside of the air tube. With one hand, hold the air tube and seal head firmly together. With your other hand, hold the air shaft valve threads and pull the air shaft out of the air tube, through the seal head, until it tops out against the seal head.

23

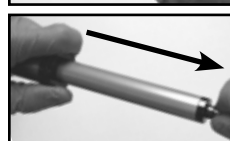

Important: Once the air shaft is fully extended from the air tube/seal head, do not continue to pull on the air shaft. If the air shaft assembly is pulled out of the bottom of the air tube, the air assembly outer o-rings will be damaged as they pass over the holes in the bottom of the air tube.

24. Lightly grease the floating piston housing outer o-ring. Set the floating piston housing aside.

24



25. Hold the air tube at a 45 degree angle. Pour 5 mL of 15wt Pit-Stop suspension oil into the top of the air tube.

25



26. Insert the floating piston housing into the top of the air tube assembly, being careful not to spill the oil from the air tube.

26



2-STEP AIR SPRING INSTALLATION INSTRUCTIONS (CONTINUED)

27. Insert the entire 2-Step assembly into the bottom of the upper tube. Carefully guide the snap ring over the air shaft, then use large internal snap ring pliers to install the snap ring into the bottom of the upper tube.

Important: Do not scratch the air spring shaft surface while installing the snap ring.

Scratches on the air spring shaft will allow air to bypass the negative piston/seal head, resulting in reduced spring/travel change performance.

27

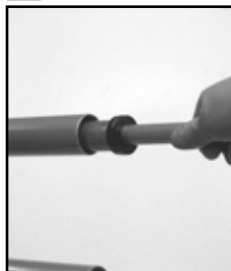

Important: Make sure the snap ring is securely fastened in the snap ring groove. You can check this by using the snap ring pliers to rotate the snap ring back and forth a couple of times, then firmly pulling down on the damper shaft.

Note: Snap rings have a sharper-edged side and a rounder-edged side. Installing snap rings with the sharper-edged side facing the tool will allow for easier installation and removal.

28

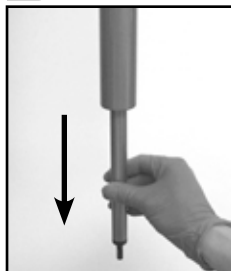

28. Pull down on the air shaft to ensure that it is extended to its maximum length. Use your finger to push down on the floating piston in the floating piston housing to ensure that it is completely bottomed out.

29. Pour 2.5 wt Pit-Stop oil into the floating piston housing, allowing oil to overflow into the upper tube around the air spring assembly. Continue to pour until the oil is level with the top of the crown.

Tip: Tap the side of the upper tube with your hand, then gently wiggle the shaft from side to side to bring any trapped air bubbles to the top. Scrape any bubbles from the top of the oil.

29



30. Use the 2-Step adjuster knob to rotate the hex shaped 2-Step adjuster located at the top of the top cap counter-clockwise, to the **max** setting. Set the adjuster knob aside. Insert the top cap into upper tube/crown and hand thread it into the upper tube. Oil will flow from the bleed port. Use a 24 mm socket wrench to tighten top cap to 7.3 N-m (65 in-lb).

30



31. Use a T10 TORX® wrench to re-install the top cap bleed screw and torque it to 1.0 N-m (8.9 in-lb). Spray the entire upper tube, crown, and top cap with isopropyl alcohol and wipe with a clean rag.

31



2-STEP AIR SPRING INSTALLATION INSTRUCTIONS (CONTINUED)

32. Install the 2-Step adjuster knob with the tab at approximately the 10 o'clock position (rider's perspective). Use a 2 mm hex wrench to install the knob fixing screw and torque it to 1.0 N·m (9 in-lb).

33. Lubricate the new Schrader valve with Pit-Stop suspension oil and install it into the bottom of the air shaft. Torque to 1.0 N·m (10 in-lb).

Important: Do not compress the air shaft until the lower leg is installed and the air spring is pressurized with air.

This concludes the spring service for your fork. You did a great job! You are now ready to move on to the next section: Lower Leg Installation.

32



33



LOWER LEG INSTALLATION

PURPOSE

Lower leg installation is the final step in completing the service of your RockShox front suspension. Be sure to look around and make sure you don't have any extra parts lying around that should be in your fork!

LOWER LEG INSTALLATION (ALL FORKS)

INTRODUCTION

At this point you should already have already serviced your fork bushings, damper system, and spring system. Once you have re-installed your fork lower legs, you will have successfully serviced your fork and you will be ready to ride!

LOWER LEG INSTALLATION INSTRUCTIONS

1. Spray the upper tubes with isopropyl alcohol and wipe them with a clean rag.
2. Pour 15wt Pit-Stop suspension oil onto new or clean foam rings, just under wiper seals inside each side of the lower leg.
3. Apply a small amount of grease to the inner surfaces of the dust wiper and oil seal.
4. Slide the lower leg assembly onto the upper tubes until you feel the lower bushings touch the end of the upper tubes.

2



3



4



Important: Make sure both dust seals slide onto the tubes correctly without folding the seals' lip.

5. Invert fork to about 45°, fork legs pointing upward. Measure and inject/pour 15 wt Pit-Stop suspension oil into lower legs through each shaft bolt hole, according to the lower leg oil volume values found in the Oil Volume chart, located in the "Getting Started" section of this manual. Wipe all excess oil from the lower legs.

5



7

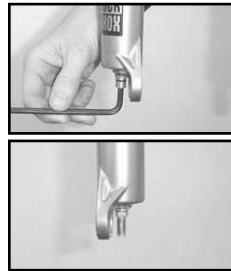

Note: For hollow bottom fork legs you will need to position the fork horizontally and use a syringe to inject oil into the lower legs from the dust wiper end prior to lower leg installation onto the upper tubes.

6. Inspect and clean the damper and air spring shaft bolts/nut, nylon crush washers and crush wash retainers. Replace crush washers and crush washer retainers if damaged.

Important: You must clean dirty crush washers and replace damaged crush washers. Dirty or damaged crush washers can cause oil to leak from the fork.

7. Insert the rebound damper and air spring shaft bolts into threaded shaft ends (or air shaft nut onto the threaded shaft end), through the lower leg shaft holes and tighten with a 5 mm hex or 10 mm socket wrench to 7.3 N-m (65 in-lb).

Note: For hollow bottom fork legs you will need to use a deep 10 mm socket to thread the Dual Air shaft nut.

LOWER LEG INSTALLATION INSTRUCTIONS (CONTINUED)

8. Insert the external rebound damper knob into the rebound damper shaft bolt. Push it in until secure. Adjust as desired.
9. For air sprung forks, refer to the air chart on your fork and inflate the positive and negative air chambers to the appropriate pressure.
10. Spray isopropyl alcohol on entire fork and wipe it with a clean rag.
11. For air sprung forks, thread the positive/negative air valve caps onto the air valves.

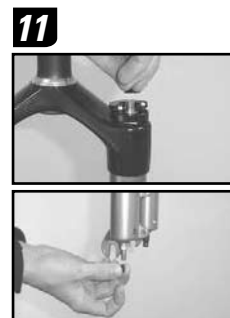
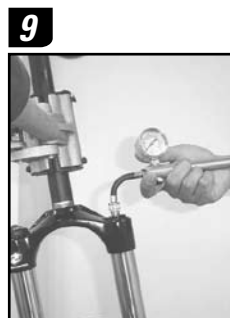

This concludes the service for your fork. You did a great job! You are now ready to install your fork on your bike and go for a ride!



BOXER

WORLD CUP

2010 Technical Manual



TABLE OF CONTENTS

GETTING STARTED	4
PARTS	4
TOOLS	4
RECORD YOUR SETTINGS	5
OIL VOLUME CHART	5
TORQUE CHART	5
ANATOMY	6
FORK REMOVAL	8
LOWER LEG REMOVAL	9
SEAL SERVICE	10
WIPER & OIL SEAL REMOVAL	10
WIPER & OIL SEAL INSTALLATION	10
AIR SPRING SERVICE	11
AIR SPRING REMOVAL INSTRUCTIONS	11
AIR SPRING SERVICE INSTRUCTIONS	12
AIR SPRING INSTALLATION INSTRUCTIONS	13
DAMPER SERVICE	15
DAMPER REMOVAL/SERVICE	15
DAMPER INSTALLATION	16
LOWER LEG INSTALLATION	18
FORK INSTALLATION	20

GETTING STARTED

This guide provides step-by-step instructions to assist in performing routine maintenance of your BoXXer front suspension fork.

PARTS

Servicing your fork will require new replacement parts such as dust seals, o-rings, oil, etc. Make sure you have all the parts available before you begin service. Refer to the RockShox Spare Parts Catalog for a complete list of all service kits and corresponding part numbers for the 2010 BoXXer World Cup.

TOOLS

The following chart is a list of the tools needed for service of your 2010 BoXXer World Cup. While this chart is intended to be comprehensive, it is still only a guide. The tools required for each step of service are detailed in the text of each service section.

TOOLS	LOWER LEG REMOVAL	OIL AND DUST SEAL SERVICE	DAMPER SERVICE	SPRING SERVICE	LOWER LEG INSTALLATION	FORK/WHEEL REMOVAL/ INSTALLATION
SAFETY/STARTING EQUIPMENT						
SAFETY GLASSES	X	X	X	X	X	X
APRON	X	X	X	X	X	X
RUBBER GLOVES	X	X	X	X	X	X
CLEAN RAGS (LINT FREE)	X	X	X	X	X	X
OIL PAN	X	X	X	X	X	X
CLEAN WORK AREA	X	X	X	X	X	X
BICYCLE STAND	X	X	X	X	X	X
WRENCHES/PLIERS						
1.5 mm HEX				X		
4 mm HEX						X
5 mm HEX	X				X	
6 mm HEX						X
12 mm SOCKET	X					
24 mm SOCKET			X	X		
24 mm FLAT WRENCH	X		X		X	
TORQUE WRENCH			X	X	X	X
SMALL SNAP RING PLIERS - EXTERNAL				X		
LARGE SNAP RING PLIERS - INTERNAL			X	X		
MISCELLANEOUS TOOLS						
SCHRADER VALVE CORE TOOL				X		
PLASTIC Mallet	X	X	X	X	X	
LONG DOWEL ROD (PLASTIC OR WOOD)		X			X	
SHARP PICK	X		X			
DOWNHILL TIRE LEVER OR LARGE FLAT HEAD SCREWDRIVER		X				
35 mm OIL SEAL/DUST WIPER INSTALLER		X				
SMALL FLAT HEAD SCREWDRIVER	X					
RULER				X		X
OIL/LIQUIDS						
PIT-STOP 5wt SUSPENSION OIL			X			
PIT-STOP 15wt SUSPENSION OIL					X	
GREASE (SUSPENSION OIL SOLUBLE)		X	X	X	X	
OIL MEASURING DEVICE		X	X	X	X	
ISOPROPYL ALCOHOL	X	X	X	X	X	X

BOXXER WORLD CUP TECHNICAL MANUAL

GETTING STARTED (CONTINUED)

RECORD YOUR SETTINGS

Take a moment and record all of your BoXXer fork settings in the chart below. This will allow you to return your fork to its original settings after service. Be sure to record the service date as well, this will help you keep track of service intervals.

To determine your bottom out, compression, and rebound settings perform the following:

Bottom Out - Count the number of clicks while turning the bottom out adjuster ⤵ fully counter-clockwise.

Rebound - Count the number of clicks while turning the rebound adjuster ⤵ fully counter-clockwise.

Compression - Count the number of clicks while turning the compression adjuster ⤵ fully counter-clockwise.

MY SETTINGS	SERVICE DATE	LOWER CROWN HEIGHT	PRESSURE SETTING	BOTTOM OUT	LOW SPEED COMPRESSION	HIGH SPEED COMPRESSION	BEGINNING STROKE REBOUND	ENDING STROKE REBOUND

The following chart lists all of the oil volumes and weights for your BoXXer as well as tool sizes and torque values for all of the fasteners.

OIL VOLUME CHART

	Damper technology (drive side)	Volume (mL)	Height (mm)	Oil wt	Volume (mL)	Oil wt	Spring technology (non-drive side)	Volume (mL)	Oil wt	Volume (mL)	Oil wt
		Upper leg			Lower leg			Upper leg		Lower leg	
		BoXXer World Cup	Mission Control DH	245	153	5		10	15	Solo Air with Volume Adjust	5

TORQUE CHART

Part/fastener	Tool size	Torque
Maxle DH (non drive-side)	6 mm	8 clicks
Maxle DH (drive-side)	6 mm	5.7 N·m (50 in-lb)
Crown bolts	4 mm	7.3 N·m (65 in-lb)
Bottom bolts	5 mm	7.3 N·m (65 in-lb)
Top caps	24 mm	7.3 N·m (65 in-lb)

ANATOMY

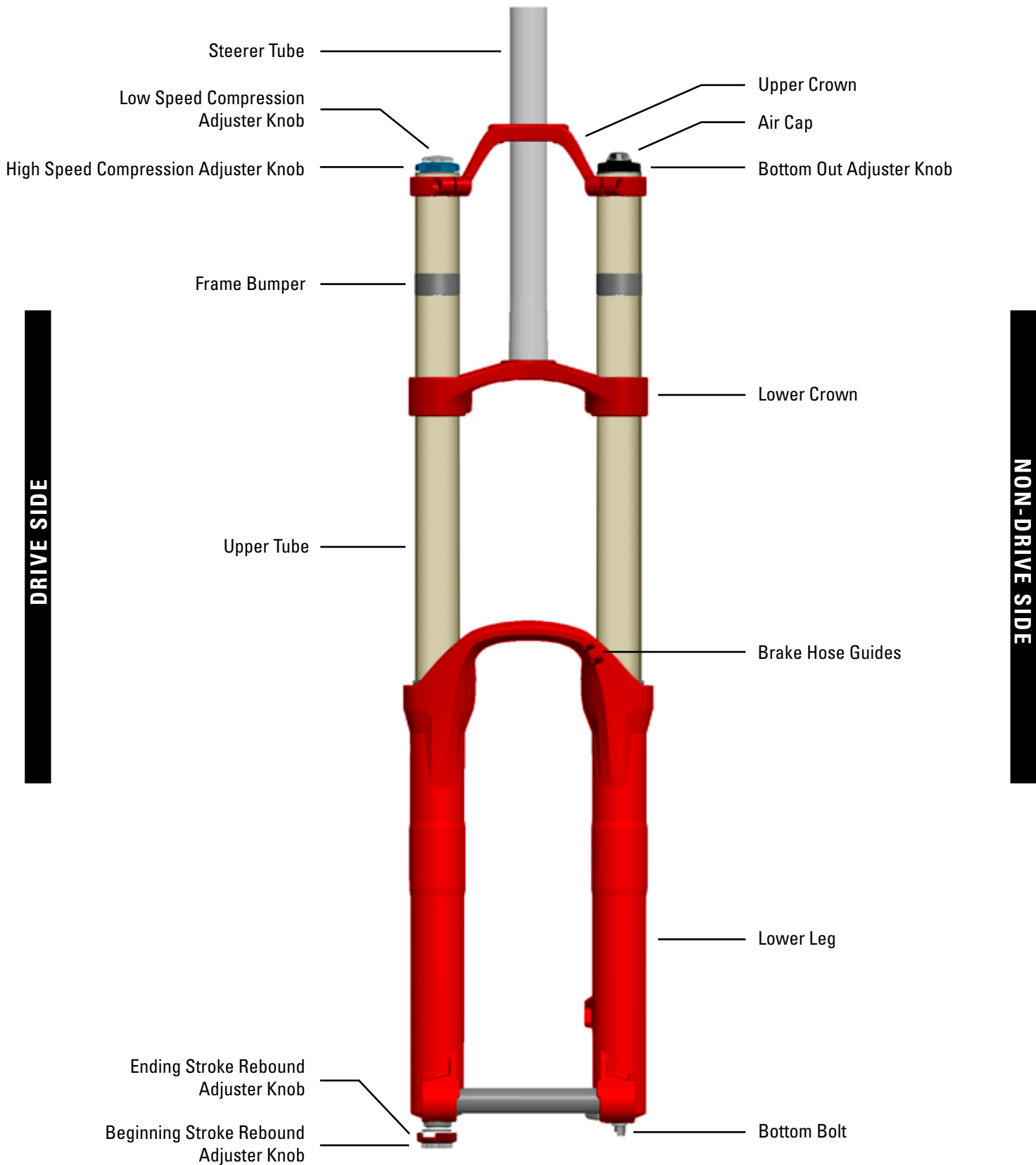

Maxle Lite DH



SAFETY FIRST!

At SRAM, we care about YOU. Please, always wear your safety glasses and protective gloves when servicing your RockShox suspension. Protect yourself! Wear your safety gear!

FORK REMOVAL

INTRODUCTION

Removing your fork from the bike is the first step required in order to perform service. BoXXer's dual crown feature allows the fork to be easily disassembled and removed from the bike. This provides easy access to internal components and is more convenient than working around a complete bike.

1. If you haven't done so already, measure and record (in the "Record Your Settings" section) the distance between the top of the lower crown and the top of the upper tube just underneath the top cap. This will make re-installing your fork easier.
2. Use a 6 mm hex wrench to loosen the Maxle™ DH bolt on the non-drive-side until detent clicks are no longer felt.
3. Use a 6 mm hex wrench to unthread and completely remove the Maxle DH from the drive-side. Pull downward on the wheel to remove it from the fork.
4. Remove the brake caliper and disconnect the brake hose from the fork.
5. Use a 4 mm hex wrench to loosen the four lower crown and two upper crown bolts that clamp the crowns to the upper tubes. Do not loosen the steerer tube clamping bolt located on the upper crown.
6. Slide the upper tubes downward until they are clear of the upper crown enough to be able to remove the frame bumpers. Lightly re-tighten one of the lower crown bolts to temporarily hold the fork in place.
7. Use your thumb and pry the thickest section of each frame bumper away from the upper tube. Spray isopropyl alcohol or water between each bumper and upper tube. Twist each bumper back and forth until it is loose on the upper tube. Slide both bumpers up and off of the upper tubes.
8. Loosen the lower crown bolt and slide the fork down through the lower crown and completely remove it from the bike.
9. Use isopropyl alcohol and a lint free rag to clean the upper tubes and the crown clamping surfaces.
10. Remove the air cap. Take a moment to check and record the air spring pressure. Use a Schrader valve core tool to depress the Schrader valve and completely depressurize the air spring. Remove the Schrader valve core.

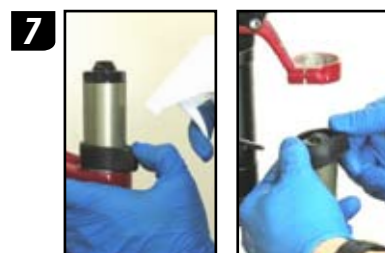
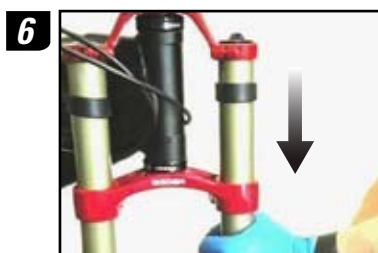
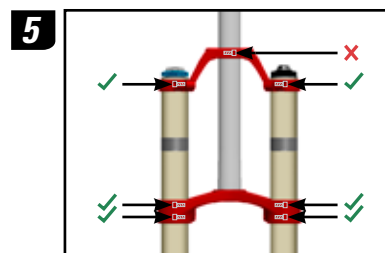
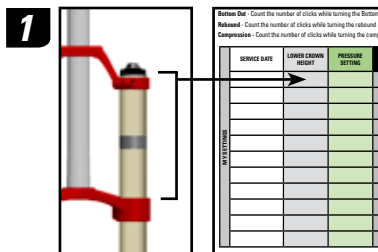

LOWER LEG REMOVAL

1. Clamp one of the upper tubes, just below the top cap, in a bike stand and place an oil pan beneath the fork to catch any draining oil.

Important: Do not scratch the upper tube while clamping it into the bike stand. Clean any debris from the stand clamping surface. A clean rag wrapped around the upper tube may be used to protect the tube surface.

2. Use a pick and a small flat bladed screwdriver to push/pull the rebound adjuster retaining clip to the side and free from the beginning stroke rebound adjuster. Remove the beginning stroke rebound adjuster, washer, and ending stroke rebound adjuster.
3. Use a 24 mm flat wrench to loosen and remove the rebound shaft bolt. Remove the crush washer and retainer from the bottom bolt then re-install two to three turns.
4. Place a 12 mm socket over the rebound adjuster shaft, against the rebound bolt. Use a plastic mallet to firmly strike the socket to free the rebound shaft from its press-fit to the lower leg.

2



3



4



LOWER LEG REMOVAL (CONTINUED)

5. Use a 5 mm hex wrench to loosen the spring shaft bolts three to four turns.
6. Use a plastic mallet to firmly strike the spring shaft bolt to free the spring shaft from its press-fit to the lower leg. Remove the spring shaft bolt and rebound bolt/adjuster assembly completely.
7. Position the fork upright in the stand and allow the oil to drain.

5



6



Note: If oil doesn't drain from either side, the press fit may not be completely released. Re-install the shaft bolt two to three turns and strike it again.

8. Remove the lower leg from the fork by firmly pulling each upper tube out of the lower leg assembly.
Important: Do not hit the brake arch with any tool when removing the lower leg as this could damage the fork. If an upper tube does not slide out of the lower leg, the press fit may not be completely released. Re-install the shaft bolt two to three turns and strike it again.
9. Allow any remaining oil in the lower leg to drain into the oil pan.
10. Spray isopropyl alcohol onto the upper tubes and clean with a lint free rag.

8



Note: Inspect the upper tubes for damage. Damage such as scratches, chips or wear marks on the surface of the upper tube can cause oil to leak during use and allow dirt and debris to contaminate the internals of the fork. Damaged upper tubes should be replaced.

SEAL SERVICE

INTRODUCTION

Suspension fork seals are considered "wear and tear" parts and require regular maintenance. The frequency of seal replacement will depend on the frequency of riding, riding terrain, rider body weight, and type of fork. The following chapter covers wiper and oil seal removal and installation.

WIPER & OIL SEAL REMOVAL

1. Position the tip of a downhill tire lever or large, flat head screwdriver underneath the lip of the lower black oil seal, above the upper bushing.
2. Stabilize the lower leg upright on a bench top or on the floor. Hold the lower leg firmly and use downward force on the tool handle to leverage both seals out at the same time.
Important: Be sure to stabilize the lower leg in order to prevent it from slipping while installing the seal. Do not allow the lower legs to twist in opposite directions, compress toward each other, or be pulled apart. This will damage the lower leg.
3. Spray isopropyl alcohol on and into the lower leg. Wipe the lower legs clean, then wrap a clean, lint free rag around a dowel and clean the inside of each lower leg.



WIPER & OIL SEAL INSTALLATION

1. Position the oil seal, with the grooved side visible, onto the stepped side of the 35 mm seal installation tool.
2. Hold one of the lower legs firmly and use the seal installation tool to push the oil seal evenly and completely into that leg. Repeat for the other leg.
Important: Be sure to stabilize the lower leg in order to prevent it from slipping while installing the seal. Do not allow the lower legs to twist in opposite directions, compress toward each other, or be pulled apart. This will damage the lower leg.
3. Position the dust wiper seal, with the grooved side visible, into the recessed side of the 35 mm seal installation tool.
4. Hold one of the lower legs firmly and use the seal installation tool to push the dust wiper evenly and completely into that leg. Repeat for the opposite leg.



AIR SPRING SERVICE

AIR SPRING REMOVAL INSTRUCTIONS

Important: Verify that all air pressure is removed from the Solo Air system before proceeding.

1. Use a 1.5 mm hex wrench to loosen the bottom out adjuster pinch bolts 1 full turn each. Remove the adjuster cap.
2. Use a 24 mm socket wrench to unthread and remove the air spring top cap. Pour any oil from the upper tube into an oil pan.
3. Use a pick to remove the top cap o-ring and bottom out adjuster o-ring. Use isopropyl alcohol to clean the bottom out adjuster threads. Apply fresh grease to the bottom out adjuster threads. Apply a few drops of suspension oil to the new o-rings and install.
4. Place the tips of large internal snap ring pliers in two of the ports in the base plate. Use the snap ring pliers to firmly press the bottom of the base plate into the upper tube and rotate until the base plate tab is behind the snap ring, out of the way of the snap ring eyelets.
5. Use large internal snap ring pliers to remove the snap ring. Guide the snap ring off of the spring shaft by hand.

Important: Do not scratch the air spring shaft surface while removing the snap ring. Scratches on the air spring shaft will allow air to bypass the seal head into the lower legs, resulting in reduced spring performance.

6. Firmly pull down on the air shaft to remove the air spring assembly from the upper tube. Clean and inspect the assembly for damage.

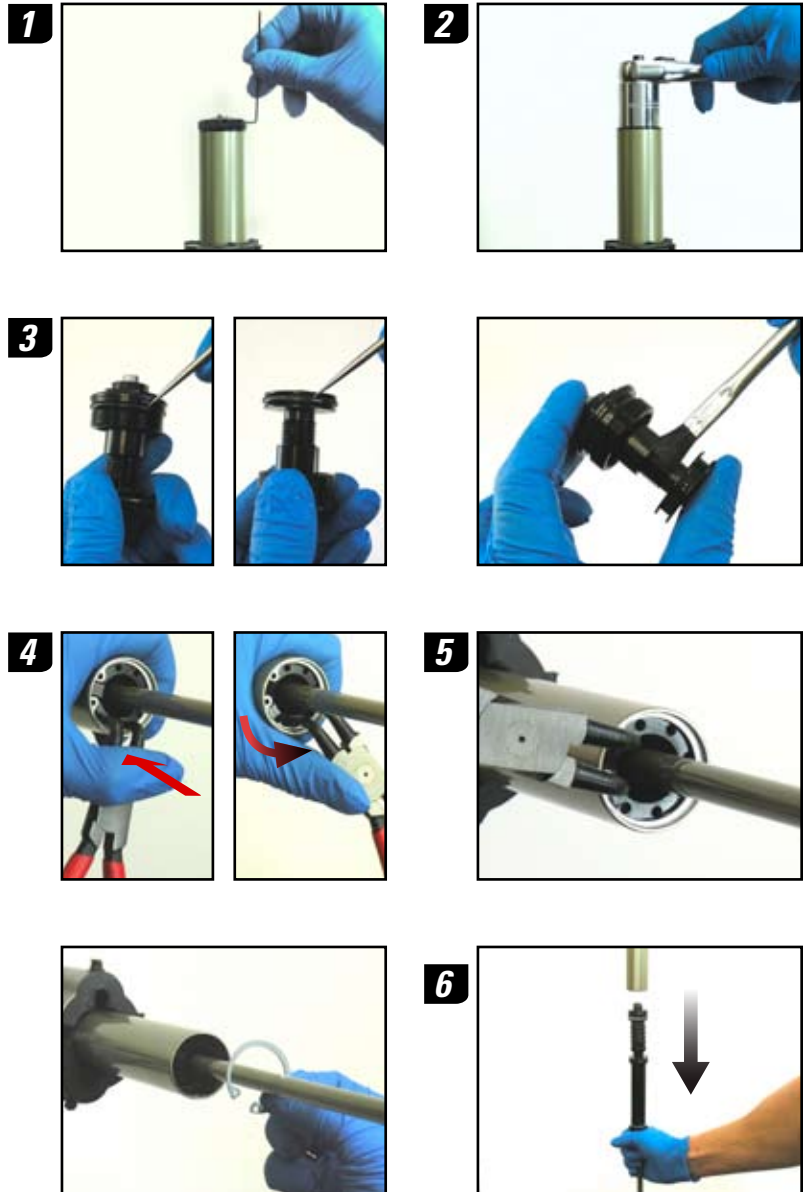

AIR SPRING SERVICE INSTRUCTIONS

7. Spray isopropyl alcohol on the inside and outside of the upper tube. Wipe the outside of the upper tube with a clean rag. Wrap a clean rag around a long dowel and insert it into the upper tube to clean inside the upper tube.
8. Use small external snap ring pliers to remove the air piston snap ring. Remove the air piston wavy spring washer, cushion, and air piston from the air shaft.

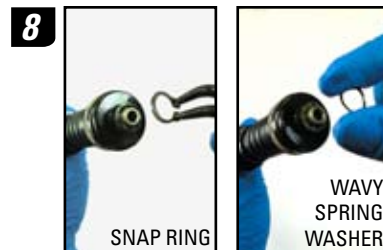

Important: Compress the snap ring just enough to disengage it from the air shaft. Over-extending the snap ring can permanently damage it and cause air spring assembly failure.

9. Use a pick to remove the face seal o-ring from the underside of the air piston. Apply a few drops of suspension oil to the new o-ring and install.

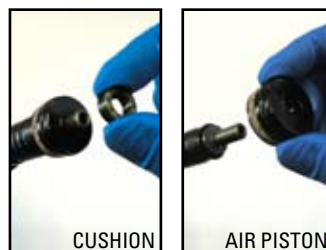

Note: Pierce the face seal o-ring with the pick and pull to remove it. Do not scoop or dig the o-ring out as this may damage the piston sealing surface.

10. Install the air piston, cushion, and spring wavy washer onto the air shaft and use small external snap ring pliers to secure the air piston snap ring in the snap ring groove. Check the snap ring fit to make sure it secures the air piston and wavy washer to the air shaft head. The air piston should compress upward slightly with spring resistance from wavy spring washer and snap ring.



Important: Compress the snap ring just enough to re-install it onto the air shaft. Over-extending the snap ring can permanently damage it and cause air spring assembly failure.

11. Use a pick to remove the air piston outer o-ring and foam ring. Install the new o-ring and a new foam ring onto the air piston. Apply a few drops of suspension oil to the new o-ring then saturate the new foam ring with suspension oil.



AIR SPRING INSTALLATION INSTRUCTIONS

12. Slide the base plate, wavy washer, aluminum support washer, negative piston top out bumper, negative piston, top out bumper, and kick plate from the air shaft. Spray the air shaft with isopropyl alcohol and wipe clean with a rag.



13. Remove the top out bumper from the negative piston. Use a pick to remove the inner and outer negative piston o-rings. Apply a few drops of suspension oil to the new o-rings and install.



Important: When using a pick to remove o-rings, do not scratch the negative piston. Scratches may cause air to leak.

14. Re-install the top out bumper and kick plate onto the negative piston.



15. Re-install the kick plate, top out bumper, and negative piston onto the air shaft with the kick plate oriented toward the air piston. Re-install the negative piston top out bumper, aluminum support washer, wavy washer, and base plate onto the air shaft with the small diameter side of the base plate oriented toward the negative piston.



Note: If the aluminum support washer and wavy washer are separated from the base plate, install the wavy washer onto the base plate first, followed by the aluminum support washer.

16. Apply grease to the air assembly outer o-rings. Insert the air assembly into the bottom of the upper tube by gently rocking the air shaft side to side while firmly pushing it into the upper tube.



17. Install the snap ring onto large internal snap ring pliers. Use the pliers to push the base plate into the upper tube while installing the snap ring into its groove. The base plate tab should be situated between the snap ring eyelets.



Important: Make sure the snap ring is securely fastened in the snap ring groove. You can check this by using the snap ring pliers to rotate the snap ring back and forth a couple of times, then firmly pulling down on the damper shaft.

Note: Snap rings have a sharper-edged side and a rounder-edged side. Installing snap rings with the sharper-edged side facing the tool will allow for easier installation and removal.

AIR SPRING INSTALLATION INSTRUCTIONS (CONTINUED)

18. Position the upper tube at a 45 degree angle. Measure and pour 5 mL of 15wt suspension oil into the upper tube.

Note: Suspension oil in the air chamber lubricates the air seal o-ring and foam ring during use and maintains the air seal.

19. Use isopropyl alcohol and a clean rag to clean the top cap, then apply a small amount of grease to the top cap threads and o-ring. Insert the top cap into the upper tube/crown and hand thread it into the upper tube. Be careful not to damage the top cap o-ring upon installation.
20. Use a 24 mm socket wrench to tighten the top cap to 7.3 N·m (65 in-lb).
21. Re-install the bottom out adjuster cap onto the top cap with the pinch bolts oriented toward the flat sections on the bottom out adjuster. Tighten the pinch bolts to 0.2-0.6 N·m (2-5 in-lb).
22. Lubricate the new Schrader valve with suspension oil and install it into the top cap. Torque to 1.0 N·m (10 in-lb).

18

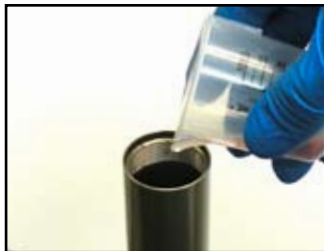

19

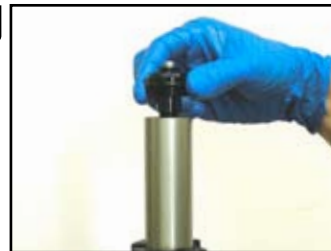

20



21



22



DAMPER SERVICE

DAMPER REMOVAL/SERVICE

1. Turn the blue high speed compression knob clockwise, to set it to the maximum compression position. Record your setting by counting the number of clicks. This will make tuning your fork after service easier.



2. Use a 24 mm flat wrench to access the top cap under the blue high speed compression knob. Unthread and remove the top cap.



3. Remove the compression damper from the upper tube by pulling up and rocking it from side to side. Once removed, clean the upper tube threads with a lint free rag.



4. Use a pick to remove the top cap o-ring. Apply a few drops of suspension oil to a new o-ring and install. Remove the glide ring from the compression damper piston assembly. Apply a few drops of suspension oil to a new glide ring and install.

5. Pour any remaining oil from the upper tube into the oil pan.



6. Push the rebound damper shaft into the seal head, leaving just enough shaft exposed to hold onto with your fingers. Use large internal snap ring pliers to remove the seal head snap ring from the snap ring groove.

Important: Do not scratch or damage the surface of the damper shaft during removal of the snap ring. Any damage will allow oil to bypass the inner o-ring during use, resulting in decreased damper performance and travel loss.

7. Orient the upper tube upright in the bicycle stand. Firmly pull down on the damper shaft and remove the rebound damper and seal head assembly from the upper tube.

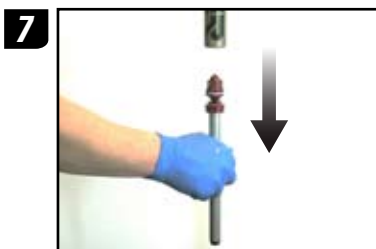

8. Slide the seal head off the damper shaft. Use a pick to remove the inner and outer seal head o-rings. Apply a few drops of suspension oil to the new o-rings and install.

Important: Do not scratch or damage the seal head during removal of the o-rings. Any damage will allow oil to bypass the o-rings during use, resulting in decreased damper performance and travel loss.

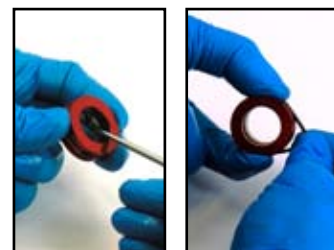

9. Spray isopropyl alcohol on the rebound damper shaft and clean with a lint free rag.

DAMPER INSTALLATION

10. Remove the glide ring from the rebound shaft assembly. Apply a few drops of suspension oil to a new glide ring and install.

11. Apply a small amount of grease to the seal head inner o-ring. Slide the rebound seal head onto the rebound damper shaft with the flat side of the seal head facing away from the piston.

Note: It is normal for some of the seal head bushing material to come off as the damper shaft is pushed through the seal head. Once the seal head is installed on the shaft, slide the seal head back and forth on the damper shaft three to four times to help clear bushing material from the seal head area. Remove any loose bushing material before re-installing the rebound assembly into the fork.

12. Spray isopropyl alcohol into the upper tube. Wrap a clean, lint free rag around a dowel and clean the inside of the upper tube.

13. Apply a small amount of grease to the seal head outer o-ring. Insert the rebound damper piston into the bottom of the upper tube at an angle, with the side of the glide ring opposite the split entering the upper tube first. Continue to angle and rotate until the glide ring is in the upper tube. Push the seal head firmly into the bottom of the upper tube until the retaining ring groove is visible.

14. Push the rebound damper shaft into the seal head, leaving just enough shaft exposed to hold onto with your fingers. Use large internal snap ring pliers to secure the snap ring into the snap ring groove.

Important: Make sure the snap ring is securely fastened in the snap ring groove. You can check this by using the snap ring pliers to rotate the snap ring back and forth a couple of times, then firmly pulling down on the damper shaft.

Note: Snap rings have a sharper-edged side and a rounder-edged side. Installing snap rings with the sharper-edged side facing the tool will allow for easier installation and removal.

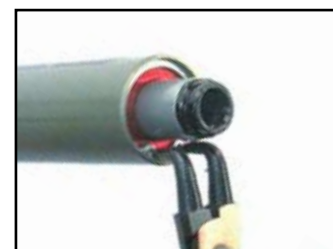
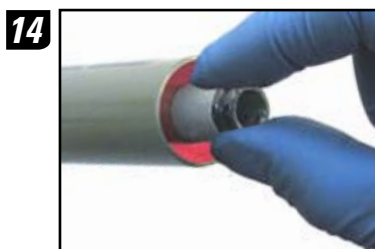
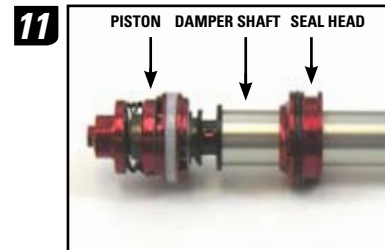

DAMPER INSTALLATION (CONTINUED)

15. Orient the fork upright in the bicycle stand. Pull the rebound damper shaft down to the fully extended position. Measure and slowly pour 245 mL of Pit-Stop 5wt suspension oil into the upper tube.

Note: You can use oil height to measure oil fill. This method is recommended for use only when the lower leg is attached to the fork. Pour suspension oil into the upper tube. Compress the fork a few times to circulate the oil throughout the damping system. If the fork is still on the bike, you will need to unweight the front of the bike to allow the fork to fully extend. Measure from the top of the upper tube to the top of the oil level. The measurement should be 153 mm. Add or remove oil as necessary.

16. Apply a small amount of grease to the compression damper top cap threads and top cap o-ring. Insert the compression damper into the top of the upper tube and push downward until the damper is fully seated in the upper tube.
17. Hand thread the compression damper clockwise into the upper tube. Use a 24 mm flat wrench to tighten the compression damper top cap to 7.3 N·m (65 in-lb). Reset the low speed compression adjuster knob to its original setting (documented in the table in the "Getting Started" section).

15



16



17



LOWER LEG INSTALLATION

1. Spray the upper tubes with isopropyl alcohol and wipe with a clean rag.

2. Clean and inspect the shaft bolts, nylon crush washers, and crush washer retainers. Replace any crush washers and crush washer retainers if damaged.

Important: You must clean dirty crush washers and replace damaged crush washers. Dirty or damaged crush washers can cause oil to leak from the fork.

3. Apply a small amount of grease to the inner surfaces of the dust wiper and oil seal.
4. Gently slide the lower leg assembly onto the upper tubes. Be sure each upper tube is inserted into its corresponding side of the lower. Slide the upper tubes into the lower leg until you feel the spring and damper shafts make contact with the inside of the legs, then pull the upper tubes back out a few centimeters to provide clearance for oil lubrication installation.

Important: Make sure both dust seals slide onto the tubes correctly without folding the seals' lip.

5. Invert the fork to about 45 degrees, with the fork legs pointing upward. Measure and inject/pour 10 mL of Pit-Stop 15wt suspension oil into both sides of the lower leg through the shaft bolt holes.

6. Slowly slide each upper tube completely into the lower leg until the shaft threads are visible through the shaft bolt holes.

Note: Sliding the upper tubes and lower legs together too quickly will cause oil to spray out of the shaft bolt holes.

7. Check for oil in the shaft threads. If there is oil in this area, use the corner of a rag to clean and dry the threads.

8. Thread the rebound damper and coil spring shaft bolts into the threaded shaft ends, through the lower leg holes. Use a 5 mm hex to tighten the spring shaft bolt to 7.3 N·m (65 in-lb). Use a 24 mm flat wrench to tighten the rebound damper shaft bolt to 7.3 N·m (65 in-lb).

3



4

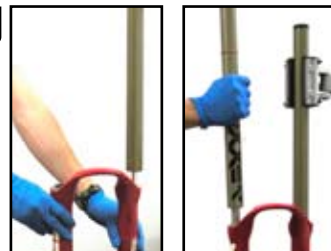

5



6



7



8



LOWER LEG INSTALLATION (CONTINUED)

9. Install the ending stroke rebound knob, washer, and beginning stroke rebound knob onto the rebound adjuster shaft.
10. Lightly push on the rebound adjusters to access the retaining clip groove. Place the retaining clip into the groove then push into place around the adjuster shaft using a small flat head screwdriver.
11. Spray isopropyl alcohol on entire fork and wipe with a clean rag.

9



10



FORK INSTALLATION

INTRODUCTION

Re-installing the fork onto the bike is the final step in servicing your BoXXer fork. Once you have installed the fork onto the bike, you'll be ready to ride!

1. Slide each upper tube through the lower crown, leaving enough clearance to install the frame bumpers.
2. Spray a liberal amount of isopropyl alcohol or water on the inner surfaces of the frame bumpers and re-install the bumpers onto the upper tubes.
3. Gently push and twist the upper tubes through the upper crown. With a minimum extension of 2 mm, position both upper tubes to extend past the top of the upper crown by an equal amount. Measure the distance from the top of the upper tube to the top of lower crown. This distance must be 156 mm (+/- 2 mm). Align the logo on the drive side upper tube with the logo on the lower leg.

Important: Refer to the BoXXer crown heights diagram for proper crown height dimensions. Improper crown height placement can cause a reduction in handling performance, travel, and/or cause fork damage.

2



3

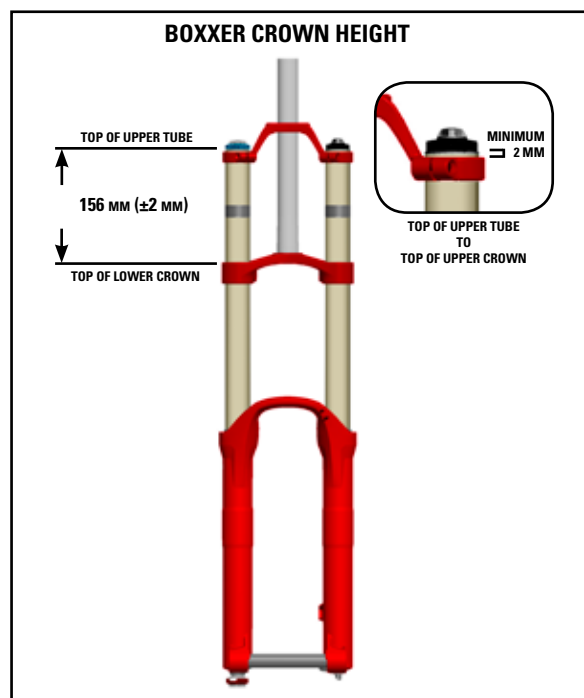

FORK INSTALLATION (CONTINUED)

4. Use a 4 mm hex wrench to torque the four lower crown bolts in an alternating fashion to 7.3 N·m (65 in-lb). Torque the two upper crown bolts to 7.3 N·m (65 in-lb).
5. Re-install the brake according to the brake manufacturer's instructions. Fasten the brake hose to the brake hose guides on the fork's lower leg.
6. Position your wheel in the lower leg dropouts. The hub should seat firmly in the dropouts. Be sure to position the disc brake rotor in the caliper. Verify that neither the rotor, hub, nor rotor bolts interfere with the lower legs. If you are unfamiliar with adjusting your disc brakes, see your brake manufacturer's instructions.
7. Slide the externally threaded end of the Maxle DH through the drive side of the hub, until it engages the threads of the lower leg dropout. Use a 6 mm hex wrench to turn the drive side axle bolt and tighten the axle into the dropout. Torque to 5.7 N·m (50 in-lb).
8. Use a 6 mm hex wrench to turn the non-drive side axle bolt clockwise until you hear or feel 8 clicks or you reach a torque value of 3.4 N·m (30 in-lb).
9. Inflate the Solo Air system to the pressure recorded prior to service. Re-check that the bottom out adjuster and all damping adjusters are at their original settings (documented in the table in the "Getting Started" section), or refer to the BoXXer World Cup Tuning Guide to aid in tuning adjustments for the rider.
10. Re-install the air valve cap.



This concludes the service for your fork. You did a great job! You are now ready to go for a ride!



BOXER_{TEAM}

2010 Technical Manual



TABLE OF CONTENTS

GETTING STARTED	4
PARTS	4
TOOLS	4
RECORD YOUR SETTINGS	5
OIL VOLUME CHART	5
TORQUE CHART	5
ANATOMY	6
FORK REMOVAL	8
LOWER LEG REMOVAL	9
SEAL SERVICE	10
WIPER & OIL SEAL REMOVAL	10
WIPER & OIL SEAL INSTALLATION	10
COIL SPRING SERVICE	11
COIL SPRING REMOVAL/SERVICE	11
COIL SPRING INSTALLATION	12
DAMPER SERVICE	13
DAMPER REMOVAL/SERVICE	13
DAMPER INSTALLATION	14
LOWER LEG INSTALLATION	16
FORK INSTALLATION	18

GETTING STARTED

This guide provides step-by-step instructions to assist in performing routine maintenance of your BoXXer front suspension fork.

PARTS

Servicing your fork will require new replacement parts such as dust seals, o-rings, oil, etc. Make sure you have all the parts available before you begin service. Refer to the RockShox Spare Parts Catalog for a complete list of all service kits and corresponding part numbers for the 2010 BoXXer Team.

TOOLS

The following chart is a list of the tools needed for service of your 2010 BoXXer Team. While this chart is intended to be comprehensive, it is still only a guide. The tools required for each step of service are detailed in the text of each service section.

TOOLS	LOWER LEG REMOVAL	OIL AND DUST SEAL SERVICE	DAMPER SERVICE	SPRING SERVICE	LOWER LEG INSTALLATION	FORK/WHEEL REMOVAL/ INSTALLATION
SAFETY/STARTING EQUIPMENT						
SAFETY GLASSES	X	X	X	X	X	X
APRON	X	X	X	X	X	X
RUBBER GLOVES	X	X	X	X	X	X
CLEAN RAGS (LINT FREE)	X	X	X	X	X	X
OIL PAN	X	X	X	X	X	X
CLEAN WORK AREA	X	X	X	X	X	X
BICYCLE STAND	X	X	X	X	X	X
WRENCHES/PLIERS						
1.5 mm HEX				X		
4 mm HEX						X
5 mm HEX	X				X	
6 mm HEX						X
12 mm SOCKET	X					
24 mm SOCKET			X	X		
24 mm FLAT WRENCH	X		X		X	
TORQUE WRENCH			X	X	X	X
LARGE SNAP RING PLIERS - INTERNAL			X	X		
MISCELLANEOUS TOOLS						
PLASTIC Mallet	X	X	X	X	X	
LONG DOWEL ROD (PLASTIC OR WOOD)		X			X	
SHARP PICK	X		X			
DOWNHILL TIRE LEVER OR LARGE FLAT HEAD SCREWDRIVER		X				
35 mm OIL SEAL/DUST WIPER INSTALLER		X				
SMALL FLAT HEAD SCREWDRIVER	X					
RULER				X		X
OIL/LIQUIDS						
PIT-STOP 5wt SUSPENSION OIL			X			
PIT-STOP 15wt SUSPENSION OIL					X	
GREASE (SUSPENSION OIL SOLUBLE)		X	X	X	X	
OIL MEASURING DEVICE		X	X	X	X	
ISOPROPYL ALCOHOL	X	X	X	X	X	X

BOXXER TEAM TECHNICAL MANUAL

GETTING STARTED (CONTINUED)

RECORD YOUR SETTINGS

Take a moment and record all of your BoXXer fork's settings in the chart below. This will allow you to return your fork to its original settings after service. Be sure to record the service date as well, this will help you keep track of service intervals.

To determine your bottom out, compression, and rebound settings perform the following:

Bottom out - Count the number of clicks while turning the bottom out adjuster ↺ fully counter-clockwise.

Rebound - Count the number of clicks while turning the rebound adjuster ↺ fully counter-clockwise.

Compression - Count the number of clicks while turning the compression adjuster ↺ fully counter-clockwise.

Note: Spring preload will be determined later during spring system service.

MY SETTINGS	SERVICE DATE	UPPER CROWN HEIGHT	NUMBER OF PRELOAD SPACERS	BOTTOM OUT	LOW SPEED COMPRESSION	HIGH SPEED COMPRESSION	BEGINNING STROKE REBOUND	ENDING STROKE REBOUND

The following chart lists all of the oil volumes and weights for your BoXXer as well as tool sizes and torque values for all of the fasteners.

OIL VOLUME CHART

BoXXer World Cup	Damper technology (drive side)	Volume (mL)	Height (mm)	Oil wt	Volume (mL)	Oil wt	Spring technology (non-drive side)	Volume (mL)	Oil wt	Volume (mL)	Oil wt
		Upper leg			Lower leg			Upper leg		Lower leg	
		Mission Control DH	245	153	5	10		15	Coil with Drop Stop	-	-

TORQUE CHART

Part/fastener	Tool size	Torque
Maxle DH (non drive-side)	6 mm	8 clicks
Maxle DH (drive-side)	6 mm	5.7 N-m (50 in-lb)
Crown bolts	4 mm	7.3 N-m (65 in-lb)
Bottom bolts	5 mm	7.3 N-m (65 in-lb)
Top caps	24 mm	7.3 N-m (65 in-lb)

ANATOMY

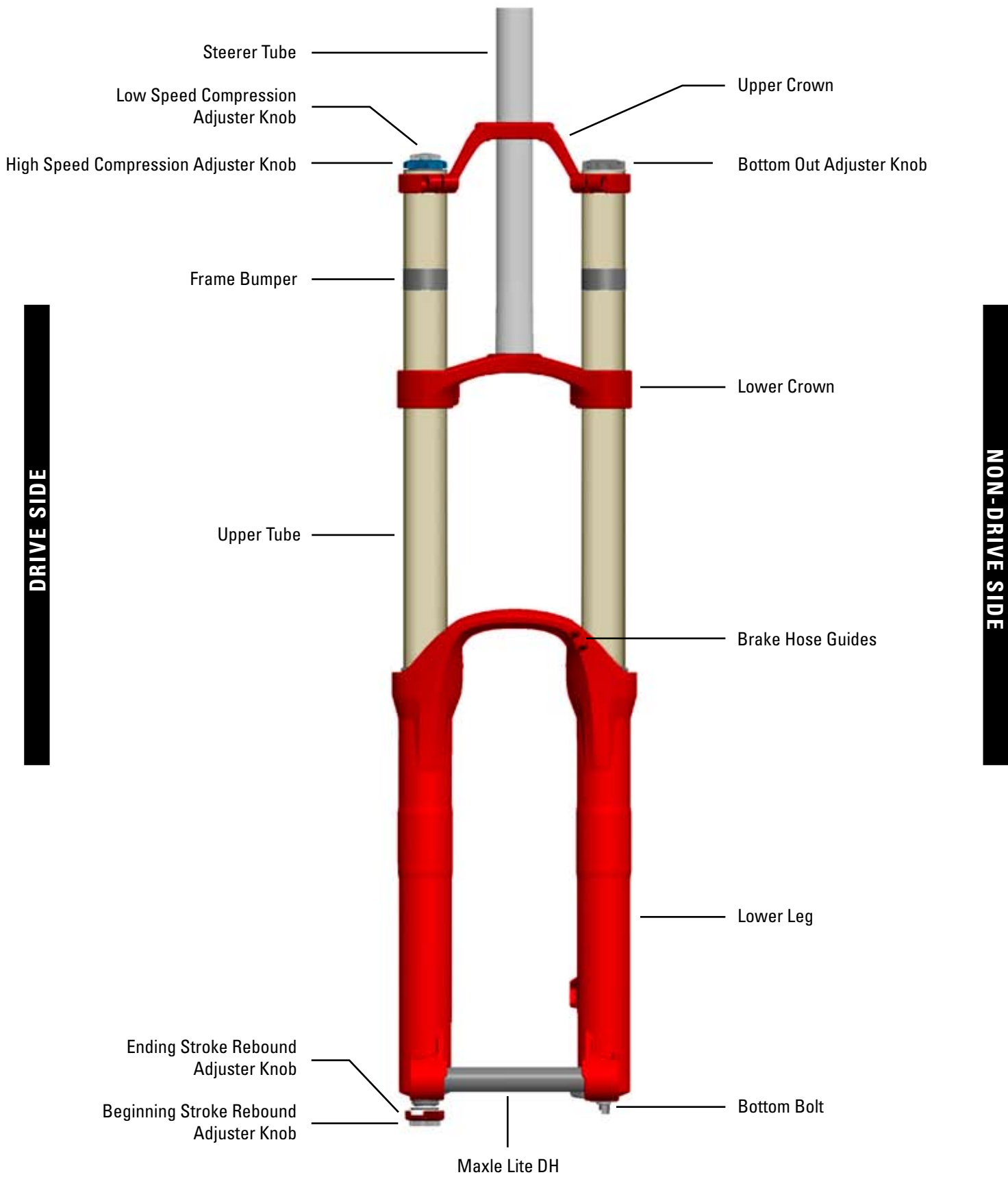



SAFETY FIRST!

At SRAM, we care about YOU. Please, always wear your safety glasses and protective gloves when servicing your RockShox suspension. Protect yourself! Wear your safety gear!

FORK REMOVAL

INTRODUCTION

Removing your fork from the bike is the first step required in order to perform service. BoXXer's dual crown feature allows the fork to be easily disassembled and removed from the bike. This provides easy access to internal components and is more convenient than working around a complete bike.

1. If you haven't done so already, measure and record (in the "Record Your Settings" section) the distance between the top of the lower crown and the top of the upper tube just underneath the top cap. This will make re-installing your fork easier.
2. Use a 6 mm hex wrench to loosen the Maxle™ DH bolt on the non-drive-side until detent clicks are no longer felt.
3. Use a 6 mm hex wrench to unthread and completely remove the Maxle DH from the drive-side. Pull downward on the wheel to remove it from the fork.
4. Remove the brake caliper and disconnect the brake hose from the fork.
5. Use a 4 mm hex wrench to loosen the four lower crown and two upper crown bolts that clamp the crowns to the upper tubes. Do not loosen the steerer tube clamping bolt located on the upper crown.
6. Slide the upper tubes downward until they are clear of the upper crown enough to be able to remove the frame bumpers. Lightly re-tighten one of the lower crown bolts to temporarily hold the fork in place.
7. Use your thumb and pry the thickest section of each frame bumper away from the upper tube. Spray isopropyl alcohol or water between each bumper and upper tube. Twist each bumper back and forth until it is loose on the upper tube. Slide both bumpers up and off of the upper tubes.
8. Loosen the lower crown bolt and slide the fork down through the lower crown and completely remove it from the bike.
9. Use isopropyl alcohol and a lint free rag to clean the upper tubes and the crown clamping surfaces.

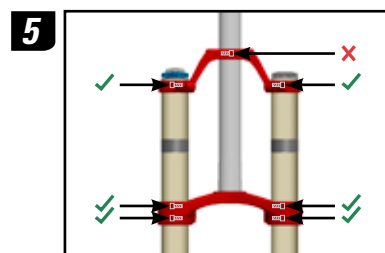
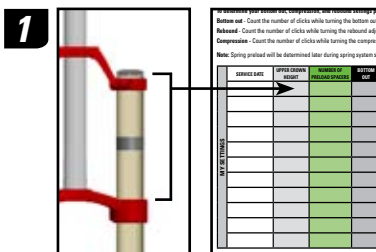

LOWER LEG REMOVAL

1. Clamp one of the upper tubes, just below the top cap, in a bike stand and place an oil pan beneath the fork to catch any draining oil.

Important: Do not scratch the upper tube while clamping it into the bike stand. Clean any debris from the stand clamping surface. A clean rag wrapped around the upper tube may be used to protect the tube surface.



2. Use a pick and a small flat bladed screwdriver to push/pull the rebound adjuster retaining clip to the side and free from the beginning stroke rebound adjuster. Remove the beginning stroke rebound adjuster, washer, and ending stroke rebound adjuster.



3. Use a 24 mm flat wrench to loosen and remove the rebound shaft bolt. Remove the crush washer and retainer from the bottom bolt then re-install two to three turns.

4. Place a 12 mm socket over the rebound adjuster shaft, against the rebound bolt. Use a plastic mallet to firmly strike the socket against the shaft bolt to free the rebound shaft from its press-fit to the lower leg.



5. Use a 5 mm hex wrench to loosen the spring shaft bolts three to four turns.
6. Use a plastic mallet to firmly strike the spring shaft bolt to free the spring shaft from its press-fit to the lower leg. Remove the spring shaft bolt and rebound bolt/adjuster assembly completely.
7. Position the fork upright in the stand and allow the oil to drain.

Note: If oil doesn't drain from either side, the press fit may not be completely released. Re-install the shaft bolt two to three turns and strike it again.

8. Remove the lower leg from the fork by firmly pulling each upper tube out of the lower leg assembly.
Important: Do not hit the brake arch with any tool when removing the lower leg as this could damage the fork. If an upper tube does not slide out of the lower leg, the press fit may not be completely released. Re-install the shaft bolt two to three turns and strike it again.

9. Allow any remaining oil in the lower leg to drain into the oil pan.

10. Spray isopropyl alcohol onto the upper tubes and clean with a lint free rag.

Note: Inspect the upper tubes for damage. Damage such as scratches, chips or wear marks on the surface of the upper tube can cause oil to leak during use and allow dirt and debris to contaminate the internals of the fork. Damaged upper tubes should be replaced.

SEAL SERVICE

INTRODUCTION

Suspension fork seals are considered "wear and tear" parts and require regular maintenance. The frequency of seal replacement will depend on the frequency of riding, riding terrain, rider body weight, and type of fork. The following chapter covers wiper and oil seal removal and installation.

WIPER & OIL SEAL REMOVAL

1. Position the tip of a downhill tire lever or large, flat head screwdriver underneath the lip of the lower black oil seal, above the upper bushing.
2. Stabilize the lower leg upright on a bench top or on the floor. Hold the lower leg firmly and use downward force on the tool handle to leverage both seals out at the same time.
Important: Be sure to stabilize the lower leg in order to prevent it from slipping while installing the seal. Do not allow the lower legs to twist in opposite directions, compress toward each other, or be pulled apart. This will damage the lower leg.
3. Spray isopropyl alcohol on and into the lower leg. Wipe the lower legs clean, then wrap a clean, lint free rag around a dowel and clean the inside of each lower leg.

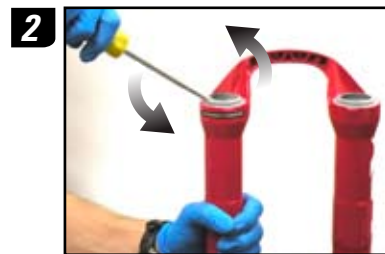

WIPER & OIL SEAL INSTALLATION

1. Position the oil seal, with the grooved side visible, onto the stepped side of the 35 mm seal installation tool.
2. Hold one of the lower legs firmly and use the seal installation tool to push the oil seal evenly and completely into that leg. Repeat for the other leg.
Important: Be sure to stabilize the lower leg in order to prevent it from slipping while installing the seal. Do not allow the lower legs to twist in opposite directions, compress toward each other, or be pulled apart. This will damage the lower leg.
3. Position the dust wiper seal, with the grooved side visible, into the recessed side of the 35 mm seal installation tool.
4. Hold one of the lower legs firmly and use the seal installation tool to push the dust wiper evenly and completely into that leg. Repeat for the opposite leg.



COIL SPRING SERVICE

COIL SPRING REMOVAL /SERVICE

1. Use a 1.5 mm hex wrench to loosen the bottom out adjuster pinch bolts 1 full turn each. Remove the adjuster cap.
2. Use a 24 mm socket wrench to unthread and remove the spring top cap. Use a pick to remove the top cap o-ring. Apply a few drops of suspension oil to the new o-ring and install.
3. Remove the spring pre-load spacer(s) then pull the coil spring from the upper tube.
4. Using a long dowel, remove the Drop Stop bumper from the coil by pushing it from the small diameter side of the coil out through the larger diameter side.
5. Use large internal snap ring pliers to remove the spring shaft base plate snap ring.
6. Pull the spring shaft and base plate from the upper tube.
7. Spray isopropyl alcohol on the coil spring, spring isolators, spring shaft, base plate, and the outside of the upper tube and wipe dry with a clean rag. Inspect the spring shaft assembly for damage. Replace entire assembly if necessary.
Note: Check the position of the spring isolators. There should be three isolators evenly spaced along the coil spring with approximately 50 mm of exposed coil at each end. If any of the isolators needs to be re-positioned, you can "thread" it along the coil by twisting it by hand. Once the isolator is positioned in place, use a heat gun or hair dryer to shrink down and secure the spring isolators around the spring. Gradually heat the isolators until they emit vapors. Be careful not to get the heat gun too close or you may burn a hole in the isolator. Allow the area to cool before handling.
8. Spray isopropyl alcohol into the upper tube. Wrap a clean, lint free rag around a long dowel and insert into the upper tube to clean inside the upper tube.

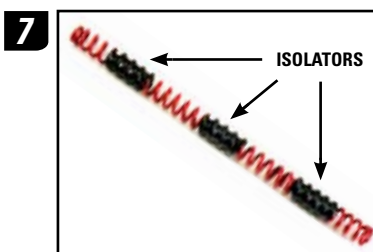
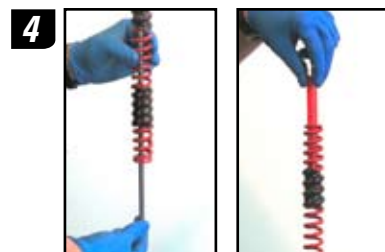
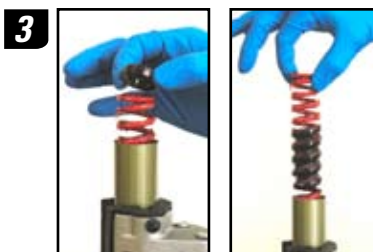

COIL SPRING INSTALLATION

9. Make sure the base plate is installed on the spring shaft so that the small top out spring is oriented toward the spring perch.
10. Insert the spring perch, spring shaft, and base plate assembly completely into the bottom of the upper tube so that the retaining ring groove is visible.

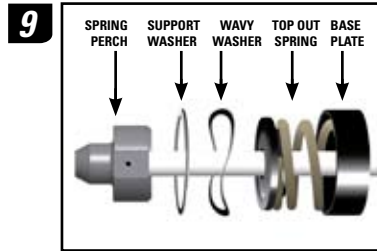

11. Use large internal snap ring pliers to secure the snap ring into the snap ring groove.
Important: Make sure the snap ring is securely fastened in the snap ring groove. You can check this by using the snap ring pliers to rotate the snap ring back and forth a couple of times, then firmly pulling down on the damper shaft.
Note: Snap rings have two unique sides. One side is flat edged, while the other is round edged. Installing snap rings with the flat edge facing the tool will allow for easier removal and installation.



12. Apply fresh grease liberally to the Drop Stop bumper, spring and spring isolators. Identify the larger diameter end of the of the coil spring and push the Drop Stop bumper into the coil from that end.
13. Use a grease brush and apply a generous amount of grease to the entire length of the coil spring. Install the coil spring, with the smaller diameter end first, into the upper tube.

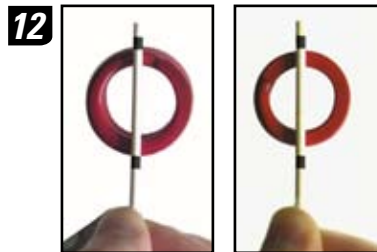

14. Use a ruler to measure the distance from the top of the coil spring to the top of the upper tube. This distance should be at least 14 mm but not more than 16 mm. If the measurement is greater than 16 mm, add preload spacers until the measurement falls between 14-16 mm (each preload spacer is 2 mm thick).



- Note: If the distance measures greater than 16 mm and is not corrected, the coil spring will experience up/down play in the upper tube and the fork will make a 'knocking' noise. If the distance is less than 14 mm, the coil spring will bind in the upper tube which can lead to damage of the coil spring.**

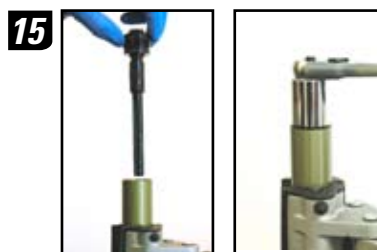

15. Clean the top cap, then apply a small amount of grease to the top cap threads and o-ring. Insert the top cap into the upper tube/crown and hand thread into upper tube. Be careful not to damage the top cap o-ring upon installation. Use a 24 mm socket wrench to tighten to 7.3 N-m (65 in-lb).
16. Re-install the bottom out adjuster cap onto the top cap. Tighten the pinch bolts to .2-.6 N-m (2-5 in-lb).

DAMPER SERVICE

DAMPER REMOVAL/SERVICE

1. Turn the blue high speed compression knob clockwise, to set it to the maximum compression position. Record your setting by counting the number of clicks. This will make tuning your fork after service easier.



2. Use a 24 mm flat wrench to access the top cap under the blue high speed compression knob. Unthread and remove the top cap.



3. Remove the compression damper from the upper tube by pulling up and rocking it from side to side. Once removed, clean the upper tube threads with a lint free rag.



4. Use a pick to remove the top cap o-ring. Apply a few drops of suspension oil to a new o-ring and install. Remove the glide ring from the compression damper piston assembly. Apply a few drops of suspension oil to a new glide ring and install.

5. Pour any remaining oil from the upper tube into the oil pan.



6. Push the rebound damper shaft into the seal head, leaving just enough shaft exposed to hold onto with your fingers. Use large internal snap ring pliers to remove the seal head snap ring from the snap ring groove.

Important: Do not scratch or damage the surface of the damper shaft during removal of the snap ring. Any damage will allow oil to bypass the inner o-ring during use, resulting in decreased damper performance and travel loss.

7. Orient the upper tube upright in the bicycle stand. Firmly pull down on the damper shaft and remove the rebound damper and seal head assembly from the upper tube.

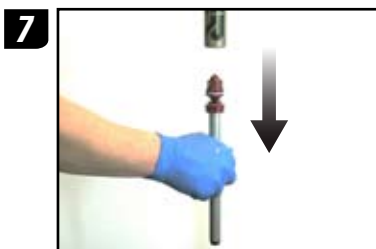

8. Slide the seal head off the damper shaft. Use a pick to remove the inner and outer seal head o-rings. Apply a few drops of suspension oil to the new o-rings and install.

Important: Do not scratch or damage the seal head during removal of the o-rings. Any damage will allow oil to bypass the o-rings during use, resulting in decreased damper performance and travel loss.

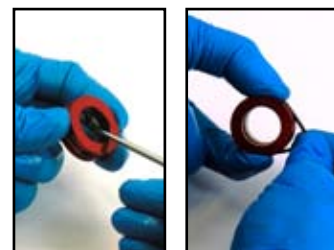

9. Spray isopropyl alcohol on the rebound damper shaft and clean with a lint free rag.

DAMPER INSTALLATION

10. Remove the glide ring from the rebound shaft assembly. Apply a few drops of suspension oil to a new glide ring and install.

11. Apply a small amount of grease to the seal head inner o-ring. Slide the rebound seal head onto the rebound damper shaft with the flat side of the seal head facing away from the piston.

Note: It is normal for some of the seal head bushing material to come off as the damper shaft is pushed through the seal head. Once the seal head is installed on the shaft, slide the seal head back and forth on the damper shaft three to four times to help clear bushing material from the seal head area. Remove any loose bushing material before re-installing the rebound assembly into the fork.

12. Spray isopropyl alcohol into the upper tube. Wrap a clean, lint free rag around a dowel and clean the inside of the upper tube.

13. Apply a small amount of grease to the seal head outer o-ring. Insert the rebound damper piston into the bottom of the upper tube at an angle, with the side of the glide ring opposite the split entering the upper tube first. Continue to angle and rotate until the glide ring is in the upper tube. Push the seal head firmly into the bottom of the upper tube until the retaining ring groove is visible.

14. Push the rebound damper shaft into the seal head, leaving just enough shaft exposed to hold onto with your fingers. Use large internal snap ring pliers to secure the snap ring into the snap ring groove.

Important: Make sure the snap ring is securely fastened in the snap ring groove. You can check this by using the snap ring pliers to rotate the snap ring back and forth a couple of times, then firmly pulling down on the damper shaft.

Note: Snap rings have a sharper-edged side and a rounder-edged side. Installing snap rings with the sharper-edged side facing the tool will allow for easier installation and removal.

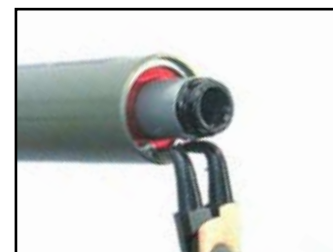
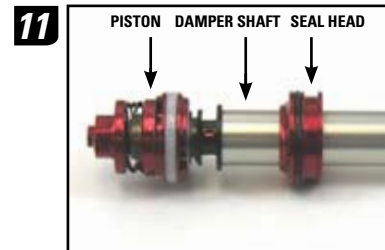

DAMPER INSTALLATION (CONTINUED)

15. Orient the fork upright in the bicycle stand. Pull the rebound damper shaft down to the fully extended position. Measure and slowly pour 245 mL of Pit-Stop 5wt suspension oil into the upper tube.

Note: You can use oil height to measure oil fill. This method is recommended for use only when the lower leg is attached to the fork. Pour suspension oil into the upper tube. Compress the fork a few times to circulate the oil throughout the damping system. If the fork is still on the bike, you will need to unweight the front of the bike to allow the fork to fully extend. Measure from the top of the upper tube to the top of the oil level. The measurement should be 153 mm. Add or remove oil as necessary.

16. Apply a small amount of grease to the compression damper top cap threads and top cap o-ring. Insert the compression damper into the top of the upper tube and push downward until the damper is fully seated in the upper tube.
17. Hand thread the compression damper clockwise into the upper tube. Use a 24 mm flat wrench to tighten the compression damper top cap to 7.3 N·m (65 in-lb). Reset the low speed compression adjuster knob to its original setting (documented in the table in the "Getting Started" section).

15



16



17



LOWER LEG INSTALLATION

1. Spray the upper tubes with isopropyl alcohol and wipe with a clean rag.

2. Clean and inspect the shaft bolts, nylon crush washers, and crush washer retainers. Replace any crush washers and crush washer retainers if damaged.

Important: You must clean dirty crush washers and replace damaged crush washers. Dirty or damaged crush washers can cause oil to leak from the fork.

3. Apply a small amount of grease to the inner surfaces of the dust wiper and oil seal.

4. Gently slide the lower leg assembly onto the upper tubes. Be sure each upper tube is inserted into its corresponding side of the lower. Slide the upper tubes into the lower leg until you feel the spring and damper shafts make contact with the inside of the legs, then pull the upper tubes back out a few centimeters to provide clearance for oil lubrication installation.

Important: Make sure both dust seals slide onto the tubes correctly without folding the seals' lip.

5. Invert the fork to about 45 degrees, with the fork legs pointing upward. Measure and inject/pour 10 mL of Pit-Stop 15wt suspension oil into the drive side lower leg through the shaft bolt hole, then inject/pour 40 mL of 15wt suspension oil into the non-drive side lower leg through the shaft bolt hole.

6. Slowly slide each upper tube completely into the lower leg until the shaft threads are visible through the shaft bolt holes.

Note: Sliding the upper tubes and lower legs together too quickly will cause oil to spray out of the shaft bolt holes.

7. Check for oil in the shaft threads. If there is oil in this area, use the corner of a rag to clean and dry the threads.

8. Thread the rebound damper and coil spring shaft bolts into the threaded shaft ends, through the lower leg holes. Use a 5 mm hex to tighten the spring shaft bolt to 7.3 N·m (65 in·lb). Use a 24 mm flat wrench to tighten the rebound

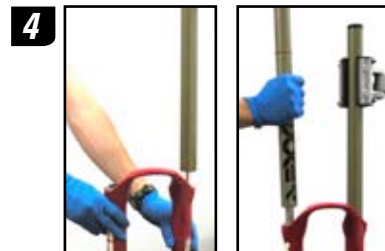

LOWER LEG INSTALLATION (CONTINUED)

damper shaft bolt to 7.3 N·m (65 in-lb).

9. Install the ending stroke rebound knob, washer, and beginning stroke rebound knob onto the rebound adjuster shaft.
10. Lightly push on the rebound adjusters to access the retaining clip groove. Place the retaining clip into the groove then push it into place around the adjuster shaft using a small flat head screwdriver.
11. Spray isopropyl alcohol on the entire fork and wipe it with a clean rag.

9



10



FORK INSTALLATION

INTRODUCTION

Re-installing the fork onto the bike is the final step in servicing your BoXXer fork. Once you have installed the fork onto the bike, you will be ready to ride!

1. Slide each upper tube through the lower crown, leaving enough clearance to install the frame bumpers.
2. Spray a liberal amount of isopropyl alcohol or water on the inner surfaces of the frame bumpers and re-install the bumpers onto the upper tubes.
3. Gently push and twist the upper tubes through the upper crown. With a minimum extension of 2 mm, position both upper tubes to extend past the top of the upper crown by an equal amount. Measure the distance from the top of the upper tube to the top of lower crown. This distance must be 156 mm (+/- 2 mm). Align the logo on the drive side upper tube with the logo on the lower leg.

Important: Refer to the BoXXer crown heights diagram for proper crown height dimensions. Improper crown height placement can cause a reduction in handling performance, travel, and/or cause fork damage.

2



3

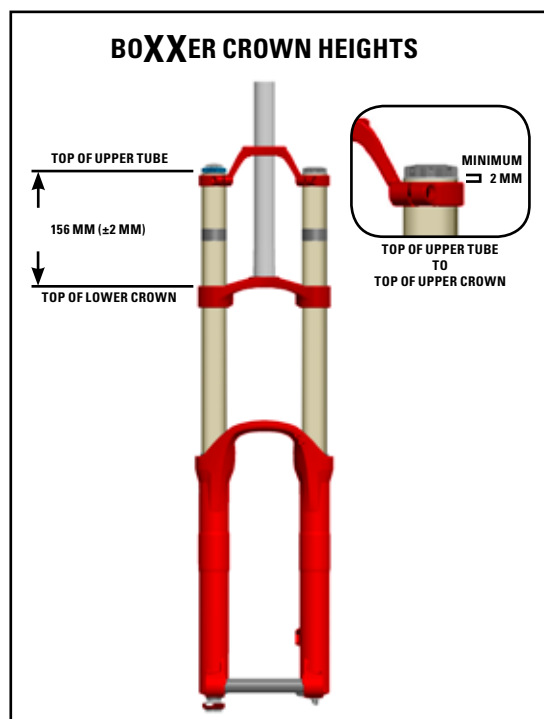
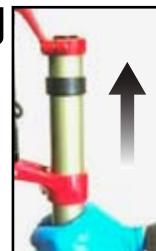

FORK INSTALLATION (CONTINUED)

4. Use a 4 mm hex wrench to torque the four lower crown bolts in an alternating fashion to 7.3 N·m (65 in-lb). Torque the two upper crown bolts to 7.3 N·m (65 in-lb).
5. Re-install the brake according to the brake manufacturer's instructions. Fasten the brake hose to the brake hose guides on the fork's lower leg.
6. Position your wheel in the lower leg dropouts. The hub should seat firmly in the dropouts. Be sure to position the disc brake rotor in the caliper. Verify that neither the rotor, hub, nor rotor bolts interfere with the lower legs. If you are unfamiliar with adjusting your disc brakes, see your brake manufacturer's instructions.
7. Slide the externally threaded end of the Maxle DH through the drive side of the hub, until it engages the threads of the lower leg dropout. Use a 6 mm hex wrench to turn the drive side axle bolt and tighten the axle into the dropout. Torque to 5.7 N·m (50 in-lb).
8. Use a 6 mm hex wrench to turn the non-drive side axle bolt clockwise until you hear or feel 8 clicks or you reach a torque value of 3.4 N·m (30 in-lb).
9. Re-check that all damping adjusters are at their original positions (documented in the table in the "Getting Started" section), or refer to the BoXXer Team Tuning Guide for tuning advice.



This concludes the service for your fork. You did a great job! You are now ready to go for a ride!



BOXER_{RACE}

2010 Technical Manual



TABLE OF CONTENTS

GETTING STARTED	4
PARTS	4
TOOLS	4
RECORD YOUR SETTINGS	5
OIL VOLUME CHART	5
TORQUE CHART	5
ANATOMY	6
FORK REMOVAL	8
LOWER LEG REMOVAL	9
SEAL SERVICE	10
WIPER & OIL SEAL REMOVAL	10
WIPER & OIL SEAL INSTALLATION	10
COIL SPRING SERVICE	11
COIL SPRING REMOVAL/SERVICE	11
COIL SPRING INSTALLATION	12
DAMPER SERVICE	13
DAMPER REMOVAL/SERVICE	13
DAMPER INSTALLATION	14
LOWER LEG INSTALLATION	16
FORK INSTALLATION	17

GETTING STARTED

This guide provides step-by-step instructions to assist in performing routine maintenance of your BoXXer front suspension fork.

PARTS

Servicing your fork will require new replacement parts such as dust seals, o-rings, oil, etc. Make sure you have all the parts available before you begin service. Refer to the RockShox Spare Parts Catalog for a complete list of all service kits and corresponding part numbers for the 2010 BoXXer Race.

TOOLS

The following chart is a list of the tools needed for service of your 2010 BoXXer Race. While this chart is intended to be comprehensive, it is still only a guide. The tools required for each step of service are detailed in the text of each service section.

TOOLS	LOWER LEG REMOVAL	OIL AND DUST SEAL SERVICE	DAMPER SERVICE	SPRING SERVICE	LOWER LEG INSTALLATION	FORK/WHEEL REMOVAL/ INSTALLATION
SAFETY/STARTING EQUIPMENT						
SAFETY GLASSES	X	X	X	X	X	X
APRON	X	X	X	X	X	X
RUBBER GLOVES	X	X	X	X	X	X
CLEAN RAGS (LINT FREE)	X	X	X	X	X	X
OIL PAN	X	X	X	X	X	X
CLEAN WORK AREA	X	X	X	X	X	X
BICYCLE STAND	X	X	X	X	X	X
WRENCHES/PLIERS						
2 mm HEX			X			
4 mm HEX						X
5 mm HEX	X				X	
6 mm HEX						X
24 mm SOCKET			X	X		
TORQUE WRENCH			X	X	X	X
LARGE SNAP RING PLIERS - INTERNAL			X	X		
MISC TOOLS						
PLASTIC MALLET	X	X	X	X	X	
LONG DOWEL ROD (PLASTIC OR WOOD)		X			X	
SHARP PICK			X			
DOWNHILL TIRE LEVER OR LARGE FLAT HEAD SCREWDRIVER		X				
35 mm OIL SEAL/DUST WIPER INSTALLER		X				
RULER				X		X
OIL/LIQUIDS						
5wt PIT-STOP SUSPENSION OIL			X			
15wt PIT-STOP SUSPENSION OIL					X	
GREASE (SUSPENSION OIL SOLUBLE)		X	X	X	X	
GRADUATED CYLINDER/BEAKER		X	X	X	X	
ISOPROPYL ALCOHOL	X	X	X	X	X	X

BOXXER RACE TECHNICAL MANUAL

GETTING STARTED (CONTINUED)

RECORD YOUR SETTINGS

Take a moment and record all of your BoXXer settings in the chart below. This will allow you to return your fork to its original settings after service. Be sure to record the service date as well, this will help you keep track of service intervals.

To determine your compression and rebound settings perform the following:

Rebound - Count the number of clicks while turning the rebound adjuster ⤴ fully counter-clockwise.

Compression - Count the number of clicks while turning the compression adjuster ⤴ fully counter-clockwise.

Note: The number of preload spacers will be determined during Spring Service.

MY SETTINGS	SERVICE DATE	UPPER CROWN HEIGHT	NUMBER OF PRELOAD SPACERS	COMPRESSION	REBOUND

The following chart lists all of the oil volumes and weights for your BoXXer as well as tool sizes and torque values for all of the fasteners.

OIL VOLUME CHART

BoXXer Race	Damper technology (drive side)	Volume (mL)	Height (mm)	Oil wt	Volume (mL)	Oil wt	Spring technology (non-drive side)	Volume (mL)	Oil wt	Volume (mL)	Oil wt
		Upper leg			Lower leg			Upper leg		Lower leg	
		290	105	5	10	15		-	-	40	15

TORQUE CHART

Part/fastener	Tool size	Torque
Maxle DH (non drive-side)	6 mm	8 clicks
Maxle DH (drive-side)	6 mm	5.7 N·m (50 in-lb)
Crown bolts	4 mm	7.3 N·m (65 in-lb)
Bottom bolts	5 mm	7.3 N·m (65 in-lb)
Top caps	24 mm	7.3 N·m (65 in-lb)
Compression adjuster bolt	2 mm	0.6-1.0 N·m (5-9 in-lb)

ANATOMY

DRIVE SIDE

NON-DRIVE SIDE

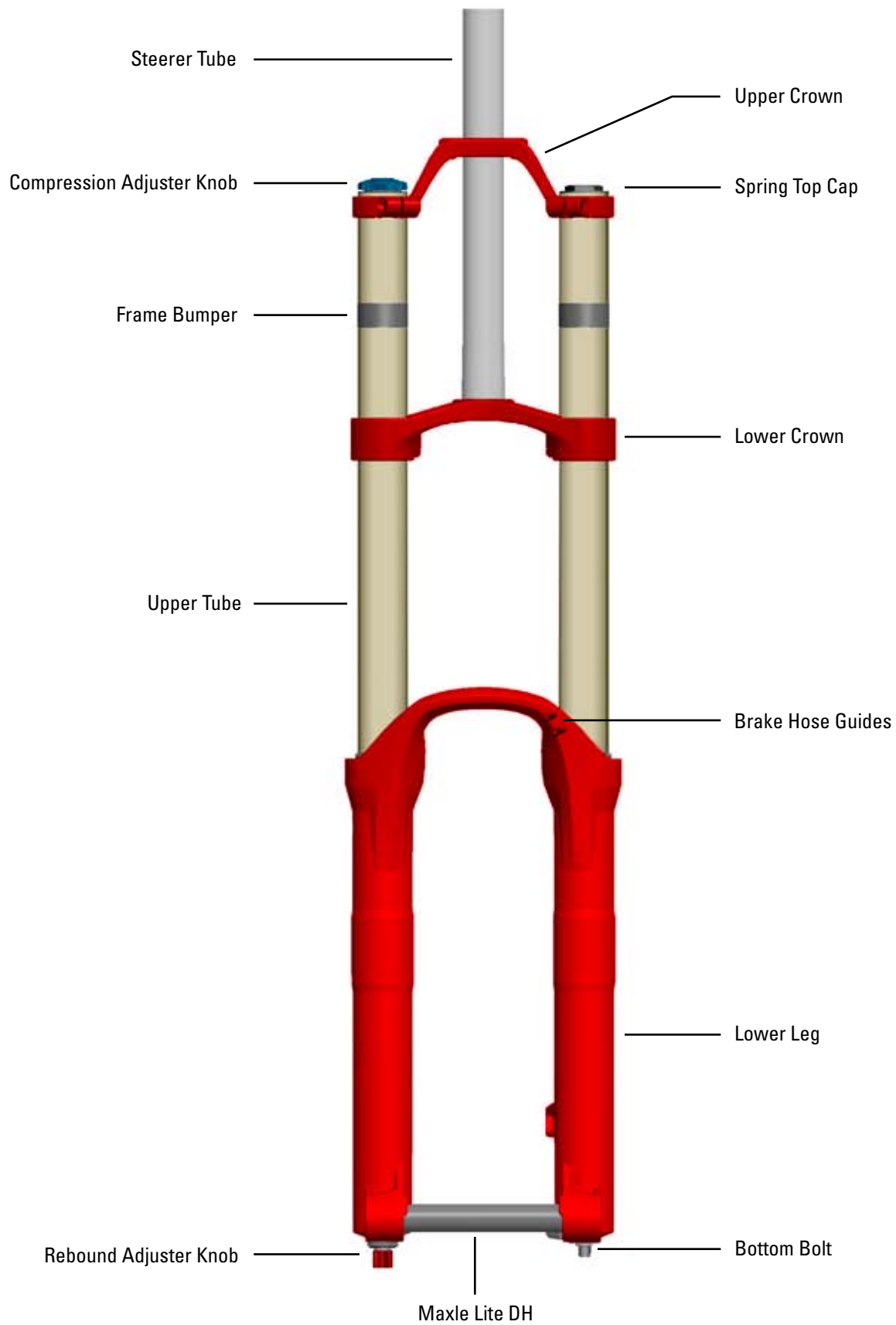



SAFETY FIRST!

At SRAM, we care about YOU. Please, always wear your safety glasses and protective gloves when servicing your RockShox suspension.

Protect yourself! Wear your safety gear!

FORK REMOVAL

INTRODUCTION

Removing your fork from the bike is the first step required in order to perform service. BoXXer's dual crown feature allows the fork to be easily disassembled and removed from the bike. This provides easy access to internal components and is more convenient than working around a complete bike.

1. If you haven't done so already, measure and record (in the "Record Your Settings" section) the distance between the top of the lower crown and the top of the upper tube just underneath the top cap. This will make re-installing your fork easier.
2. Use a 6 mm hex wrench to loosen the Maxle™ DH bolt on the non-drive side until detent clicks are no longer felt.
3. Use a 6 mm hex wrench to unthread and completely remove the Maxle DH from the drive side. Pull downward on the wheel to remove it from the fork.
4. Remove the brake caliper and disconnect the brake hose from the fork.
5. Use a 4 mm hex wrench to loosen the four lower crown and two upper crown bolts that clamp the crowns to the upper tubes. Do not loosen the steerer tube clamping bolt located on the upper crown.
6. Slide the upper tubes downward until they are clear of the upper crown enough to be able to remove the frame bumpers. Lightly re-tighten one of the lower crown bolts to temporarily hold the fork in place.
7. Use your thumb and pry the thickest section of each frame bumper away from the upper tube. Spray isopropyl alcohol or water between each bumper and upper tube. Twist each bumper back and forth until it is loose on the upper tube. Slide both bumpers up and off of the upper tubes.
8. Loosen the lower crown bolt and slide the fork down through the lower crown and completely remove it from the bike.
9. Use isopropyl alcohol and a lint free rag to clean the upper tubes and the crown clamping surfaces.

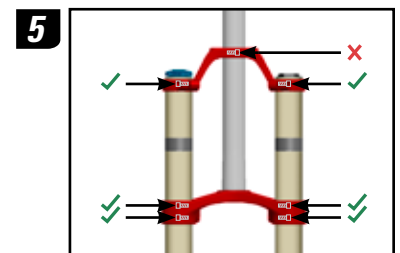
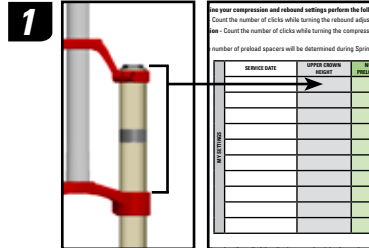

LOWER LEG REMOVAL

1. Clamp one of the upper tubes, just below the top cap, in a bike stand and place an oil pan beneath the fork to catch any draining oil.

Important: Do not scratch the upper tube while clamping it into the bike stand. Clean any debris from the stand clamping surface. A clean rag wrapped around the upper tube may be used to protect the tube surface.

2. Firmly pull the external rebound adjuster knob and remove it from the drive side shaft bolt.
3. Use a 5 mm hex wrench to loosen both shaft bolts three to four turns.
4. Use a plastic mallet to firmly strike each shaft bolt to free the shafts from their press-fit to the lower leg. Remove the shaft bolts completely and allow the oil to drain.

Note: If oil doesn't drain from either side, the press-fit may not be completely released. Re-install the shaft bolt two to three turns and strike it again.

5. Remove the lower leg from the fork by firmly pulling each upper tube out of the lower leg assembly.
Important: Do not hit the brake arch with any tool when removing the lower leg as this could damage the fork. If an upper tube does not slide out of the lower leg, the press-fit may not be completely released. Re-install the shaft bolt 2 to 3 turns and strike it again.

6. Allow any remaining oil in the lower leg to drain into the oil pan.

7. Spray isopropyl alcohol onto the upper tubes and clean with a lint free rag.

Note: Inspect the upper tubes for damage. Damage such as scratches, chips or wear marks on the surface of the upper tube can cause oil to leak during use and allow dirt and debris to contaminate the internals of the fork. Damaged upper tubes should be replaced.

2



3



4



5

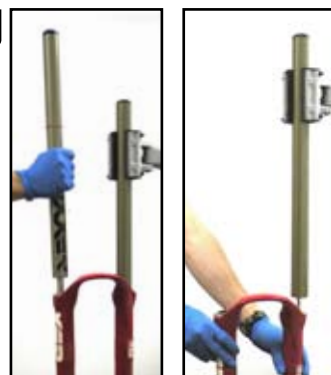

SEAL SERVICE

INTRODUCTION

Suspension fork seals are considered "wear and tear" parts and require regular maintenance. The frequency of seal replacement will depend on the frequency of riding, riding terrain, rider body weight, and type of fork. The following chapter covers wiper and oil seal removal and installation.

WIPER & OIL SEAL REMOVAL

1. Position the tip of a downhill tire lever or large, flat head screwdriver underneath the lip of the lower black oil seal, above the upper bushing.
2. Stabilize the lower leg upright on a bench top or on the floor. Hold the lower leg firmly and use downward force on the tool handle to leverage both seals out at the same time.
Important: Be sure to stabilize the lower leg in order to prevent it from slipping while installing the seal. Do not allow the lower legs to twist in opposite directions, compress toward each other, or be pulled apart. This will damage the lower leg.
3. Spray isopropyl alcohol on and into the lower leg. Wipe the lower legs clean, then wrap a clean, lint free rag around a dowel and clean the inside of each lower leg.



WIPER & OIL SEAL INSTALLATION

1. Position the oil seal, with the grooved side visible, onto the stepped side of the 35 mm seal installation tool.
2. Hold one of the lower legs firmly and use the seal installation tool to push the oil seal evenly and completely into that leg. Repeat for the other leg.
Important: Be sure to stabilize the lower leg in order to prevent it from slipping while installing the seal. Do not allow the lower legs to twist in opposite directions, compress toward each other, or be pulled apart. This will damage the lower leg.
3. Position the dust wiper seal, with the grooved side visible, into the recessed side of the 35 mm seal installation tool.
4. Hold one of the lower legs firmly and use the seal installation tool to push the dust wiper evenly and completely into that leg. Repeat for the opposite leg.



COIL SPRING SERVICE

COIL SPRING REMOVAL/SERVICE

1. Use a 24 mm socket wrench to unthread and remove the spring top cap. Use a pick to remove the top cap o-ring. Apply a few drops of suspension oil to a new o-ring and install.
2. Remove the spring pre-load spacer(s) then pull the coil spring from the upper tube.
3. Use large internal snap ring pliers to remove the spring shaft base plate snap ring.
4. Pull the spring shaft and base plate from the upper tube.
5. Spray isopropyl alcohol on the coil spring, spring isolators, spring shaft, base plate, and the outside of the upper tube and wipe dry with a clean rag. Inspect the spring shaft assembly for damage. Replace entire assembly if necessary.
Note: Check the position of the spring isolators. There should be three isolators evenly spaced along the coil spring with approximately 50 mm of exposed coil at each end. If any of the isolators needs to be re-positioned, you can "thread" it along the coil by twisting it by hand. Once the isolator is positioned in place, use a heat gun or hair dryer to shrink down and secure the spring isolators around the spring. Gradually heat the isolators until they emit vapors. Be careful not to get the heat gun too close or you may burn a hole in the isolator. Allow the area to cool before handling.
6. Spray isopropyl alcohol into the upper tube. Wrap a clean, lint free rag around a long dowel and insert into the upper tube to clean inside the upper tube.

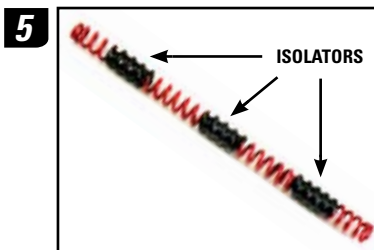

COIL SPRING INSTALLATION

7. Make sure the base plate is installed on the spring shaft so that the small top out spring is oriented toward the spring perch.
8. Insert the spring perch, spring shaft, and base plate assembly completely into the bottom of the upper tube so that the retaining ring groove is visible.
9. Use large internal snap ring pliers to secure the snap ring into the snap ring groove.

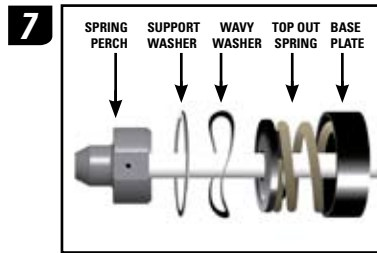

Important: Make sure the snap ring is securely fastened in the snap ring groove. You can check this by using the snap ring pliers to rotate the snap ring back and forth a couple of times, then firmly pulling down on the damper shaft.

Note: Snap rings have two unique sides. One side is flat edged, while the other is round edged. Installing snap rings with the flat edge facing the tool will allow for easier removal and installation.



10. Identify the smaller diameter end of the coil spring. Use a grease brush and apply a generous amount of grease to the entire length of the coil spring. Install the coil spring, with the smaller diameter end first, into the upper tube.
11. Use a ruler to measure the distance from the top of the coil spring to the top of the upper tube. This distance should be at least 14 mm but not more than 16 mm. If the measurement is greater than 16 mm, add preload spacers until the measurement falls between 14-16 mm (each preload spacer is 2 mm thick).

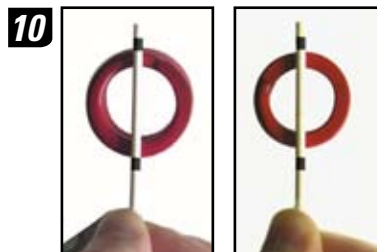

Note: If the distance measures greater than 16 mm and is not corrected, the coil spring will experience up/down play in the upper tube and the fork will make a 'knocking' noise. If the distance is less than 14 mm, the coil spring will bind in the upper tube which can lead to damage of the coil spring.

12. Clean the top cap, then apply a small amount of grease to the top cap threads and o-ring. Insert the top cap into the upper tube/crown and hand thread it into the upper tube. Be careful not to damage the top cap o-ring upon installation. Use a 24 mm socket wrench to tighten to 7.3 N-m (65 in-lb).

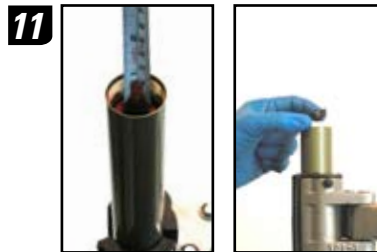

DAMPER SERVICE

DAMPER REMOVAL/SERVICE

1. Turn the compression adjuster knob counter-clockwise until it stops. Record your setting by counting the number of clicks. This will make tuning your fork after service easier.
2. Use a 2 mm hex wrench to remove the compression adjuster knob retaining bolt. Remove the compression adjuster knob.
3. Use a 24 mm socket wrench to unthread the compression damper top cap.



4. Remove the compression damper from the upper tube by pulling it up and rocking side to side. Once removed, clean the upper tube threads with a rag.



5. Use a pick to remove the compression damper o-rings located at the top and bottom of the damper. Apply a few drops of suspension oil to the new o-rings and install.

Important: Do not scratch or damage the top cap or the surface of the piston during removal of the o-rings. Any damage will allow oil to bypass the o-rings during use, resulting in oil leakage and decreased damper performance.

6. Pour any remaining oil from the upper tube into the oil pan.

7. Push the rebound damper shaft into the seal head, leaving just enough shaft exposed to hold onto with your fingers. Use large internal snap ring pliers to remove the seal head snap ring from the snap ring groove.



Important: Do not scratch or damage the surface of the damper shaft during removal of the snap ring. Any damage will allow oil to bypass the inner o-ring during use, resulting in decreased damper performance and travel loss.

8. Position the upper tube upright. Firmly pull down on the damper shaft and remove the rebound damper and seal head assembly from the upper tube.



9. Slide the seal head off the damper shaft. Use a pick to remove the inner and outer seal head o-rings. Apply a few drops of suspension oil to the new o-rings and install.
- Important: Do not scratch or damage the seal head during removal of the o-rings. Any damage will allow oil to bypass the o-rings during use, resulting in decreased damper performance and travel loss.**

DAMPER INSTALLATION

10. Spray isopropyl alcohol on the rebound damper shaft and clean with a lint free rag.
11. Remove the glide ring from the rebound shaft assembly. Apply a few drops of suspension oil to a new glide ring and install.
12. Apply a small amount of grease to the seal head inner o-ring. Slide the rebound seal head onto the rebound damper shaft with the stepped side of the seal head oriented toward the piston.
13. Spray isopropyl alcohol into the upper tube. Wrap a clean, lint free rag around a dowel and clean the inside of the upper tube.
14. Apply a small amount of grease to the seal head outer o-ring. Insert the rebound damper piston into the bottom of the upper tube at an angle, with the side of the glide ring opposite the split entering the upper tube first. Continue to angle and rotate until the glide ring is in the upper tube. Push the seal head firmly into the bottom of the upper tube until the retaining ring groove is visible.
15. Push the rebound damper shaft into the seal head, leaving just enough shaft exposed to hold onto with your fingers. Use large internal snap ring pliers to secure the snap ring into the snap ring groove.

Important: Make sure the snap ring is securely fastened in the snap ring groove. You can check this by using the snap ring pliers to rotate the snap ring back and forth a couple of times, then firmly pulling down on the damper shaft.

Note: Snap rings have a sharper-edged side and a rounder-edged side. Installing snap rings with the sharper-edged side facing towards the tool will allow for easier installation and removal.

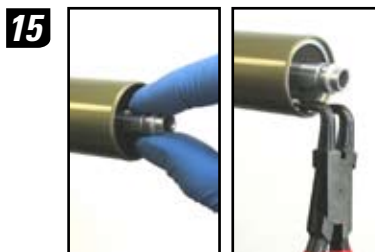
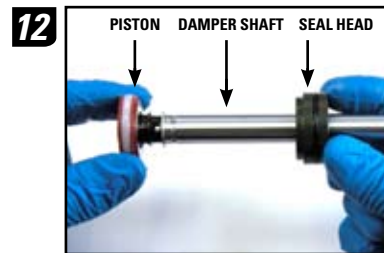

DAMPER INSTALLATION (CONTINUED)

16. Make sure that the fork is upright in the bicycle stand. Pull the rebound damper shaft down to the fully extended position. Measure and slowly pour 290 mL of 5wt Pit-Stop suspension oil into the upper tube.

Note: You can use oil height to measure oil fill. This method is recommended for use only when the lower leg is attached to the fork. Pour suspension oil into the upper tube. Compress the fork a few times to circulate the oil throughout the damping system. If the fork is still on the bike, you will need to unweight the front of the bike to allow the fork to fully extend. Measure from the top of the upper tube to the top of the oil level. The measurement should be 105 mm. Add or remove oil as necessary.

17. Apply a small amount of grease to the compression damper top cap threads, top cap o-ring, and piston o-ring. Insert the compression damper into the top of the upper tube and push downward until the damper is fully seated in the upper tube.
18. Use a 24 mm socket wrench to thread the compression damper into the upper tube and tighten to 7.3 N·m (65 in-lb).
19. Re-install the compression adjuster knob and retaining bolt. Tighten the retaining bolt to 0.6-1 N·m (5-9 in-lb). Reset the compression adjuster knob to its original setting (documented in the table in the "Getting Started" section).

16

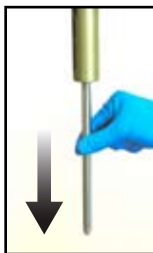

17



18



19



LOWER LEG INSTALLATION

1. Spray the upper tubes with isopropyl alcohol and wipe with a clean rag.

2. Clean and inspect the shaft bolts, nylon crush washers, and crush washer retainers. Replace any crush washers and crush washer retainers if damaged.

Important: You must clean dirty crush washers and replace damaged crush washers. Dirty or damaged crush washers can cause oil to leak from the fork.

3. Apply a small amount of grease to the inner surfaces of the dust wiper and oil seal.
4. Gently slide the lower leg assembly onto the upper tubes. Be sure each upper tube is inserted into its corresponding side of the lower. Slide the upper tubes into the lower leg until you feel the spring and damper shafts make contact with the inside of the legs, then pull the upper tubes back out a few centimeters to provide clearance for oil lubrication installation.

Important: Make sure both dust seals slide onto the tubes correctly without folding the seals' lip.

5. Invert the fork to about 45 degrees, with the fork legs pointing upward. Measure and pour 10 mL of 15wt Pit-Stop suspension oil into the drive side lower leg through the shaft bolt hole, then inject/pour 40 mL of 15wt suspension oil into the non-drive side lower leg through the shaft bolt hole.

6. Slowly slide each upper tube completely into the lower leg until the shaft threads are visible through the shaft bolt holes.

Note: Sliding the upper tubes and lower legs together too quickly will cause oil to spray out of the shaft bolt holes.

7. Check for oil in the shaft threads. If there is oil in this area, use the corner of a rag to clean and dry the threads.

8. Thread the rebound damper and coil spring shaft bolts into the threaded shaft ends, through the lower leg holes. Use a 5 mm hex to tighten bolts to 7.3 N·m (65 in-lb).

9. Insert the external rebound adjuster knob onto the rebound shaft bolt. To secure the rebound adjuster, press firmly to engage the retaining clip on the shaft bolt.

10. Spray isopropyl alcohol on the entire fork and wipe it with a clean rag.

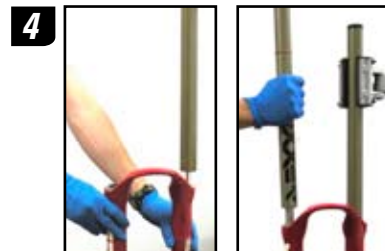

FORK INSTALLATION

INTRODUCTION

Re-installing the fork onto your bike is the final step in servicing your BoXXer fork. Once you have installed the fork onto your bike, you will be ready to ride!

1. Slide each upper tube through the lower crown, leaving enough clearance to install the frame bumpers.
2. Spray a liberal amount of isopropyl alcohol or water on the inner surface of the frame bumpers and re-install the bumpers onto the upper tubes.
3. Gently push and twist the upper tubes through the upper crown. With a minimum extension of 2 mm, position both upper tubes to extend past the top of the upper crown by an equal amount. Measure the distance from the top of the upper tube to the top of lower crown. This distance must be 156 mm (+/- 2 mm). Align the logo on the drive side upper tube with the logo on the lower leg.

Important: Refer to the BoXXer crown heights diagram for proper crown height dimensions. Improper crown height placement can cause a reduction in handling performance, travel, and/or cause fork damage.

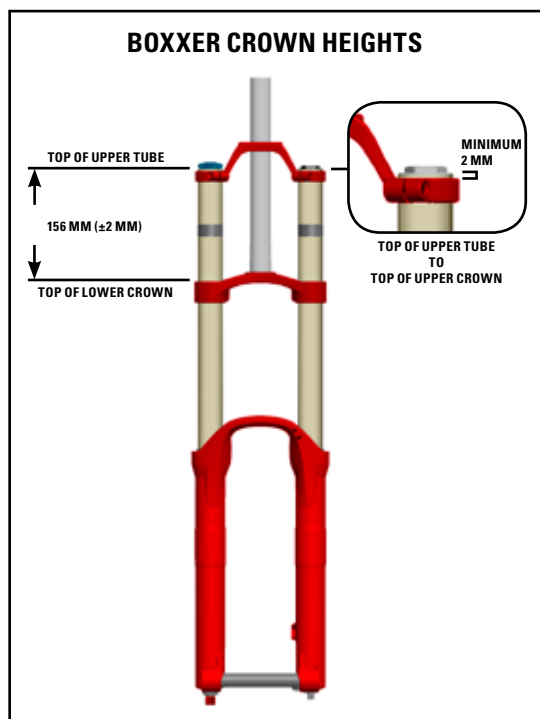
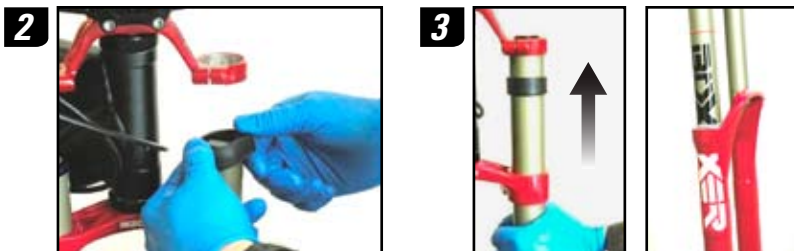

FORK INSTALLATION (CONTINUED)

4. Use a 4 mm hex wrench to torque the four lower crown bolts in an alternating fashion to 7.3 N·m (65 in-lb). Torque the two upper crown bolts to 7.3 N·m (65 in-lb).
5. Re-install the brake according to the brake manufacturer's instructions. Fasten the brake hose to the brake hose guides on the fork's lower leg.
6. Position your wheel in the lower leg dropouts. The hub should seat firmly in the dropouts. Be sure to position the disc brake rotor in the caliper. Verify that neither the rotor, hub, nor rotor bolts interfere with the lower legs. If you are unfamiliar with adjusting your disc brakes, see your brake manufacturer's instructions.
7. Slide the externally threaded end of the Maxle DH through the drive side of the hub, until it engages the threads of the lower leg dropout. Use a 6 mm hex wrench to turn the drive side axle bolt and tighten the axle into the dropout. Torque to 5.7 N·m (50 in-lb).
8. Use a 6 mm hex wrench to turn the non-drive side axle bolt clockwise until you hear or feel 8 clicks or you reach a torque value of 3.4 N·m (30 in-lb).
9. Re-check that all damping adjusters are at their original positions (documented in the table in the "Getting Started" section), or refer to the BoXXer Race Tuning Guide for tuning advice.



This concludes the service for your fork. You did a great job! You are now ready to go for a ride!

REAR SHOCK SERVICE - GETTING STARTED

KEY

RockShox rear suspension service is separated by the name of the rear shock. Performing routine service on your rear shock will help maintain its consistent and plush performance, as well as reduce overall maintenance costs.

TOOLS NEEDED FOR SERVICE (ALL REAR SHOCKS)

The following chart is a list of the model year 2010 tools needed for service on your RockShox rear shock. While this chart is intended to be comprehensive, it is still only a guide. The tools required for each step of service are detailed in the text of each service section. Keep in mind your specific shock may not require every tool listed.

TOOLS	BAR	MONARCH/ ARIO	VIVID
SAFETY/STARTING EQUIPMENT			
SAFETY GLASSES	X	X	X
APRON	X	X	X
RUBBER GLOVES	X	X	X
CLEAN RAGS (LINT FREE)	X	X	X
OIL PAN	X	X	X
CLEAN WORK AREA	X	X	X
BENCH VICE	X	X	X
SOFT JAWS	X	X	X
SHAFT CLAMP			X
WRENCHES/PLIERS			
1.5 mm HEX		X	
2 mm HEX		X	X
2.5 mm HEX		X	X
13 mm WRENCH			X
30 mm FLAT WRENCH			X
ADJUSTABLE WRENCH		X	X
CROW'S FOOT WRENCH		X	
TORQUE WRENCH		X	X
T10 TORX® WRENCH			X
24 mm PIN SPANNER			X
SLIP JOINT PLIERS	X		
MISC TOOLS			
AIR COMPRESSOR WITH BLOW GUN CHUCK		X	
GAUGED AIR PUMP	X	X	X
MONARCH AIR PUMP ADAPTER		X	
VIVID AIR PUMP ADAPTER			X
MOUNT HARDWARE/EYELET BUSHING TOOL		X	X
SHAFT CLAMPS			X
24 mm PIN SPANNER			X
SHARP PICK	X	X	X
SHOCK PUMP	X	X	X
SCHRADER VALVE CORE REMOVAL TOOL		X	
STRAP WRENCH		X	
OIL/LIQUIDS			
7wt PIT-STOP REAR SHOCK FLUID		X	
3wt PIT-STOP REAR SHOCK FLUID			X
GREASE		X	X
OIL MEASURING DEVICE	X	X	X
ISOPROPYL ALCOHOL	X	X	X
RED THREADLOCK			X

REAR SHOCK SERVICE (BAR)

INTRODUCTION

Prior to servicing your rear shock, you will first need to remove it from your bicycle frame according to your bicycle manufacturer's instructions. Once your shock is off your bicycle, you will need to remove the mounting hardware before performing any service.

AIR CAN REMOVAL/SERVICE INSTRUCTIONS

1. Use either your fingers or a pair of pliers to remove the shock mounting hardware.
2. Spray isopropyl alcohol on the the entire shock and wipe it with a clean rag.
3. Remove the air valve cap. Use a small hex wrench or pick to depress the Schrader valve and release all air pressure from the shock. Use a Schrader valve tool to remove the valve core.
Important: To avoid injury, all air pressure must be released from the shock prior to removing the air can.

1



3

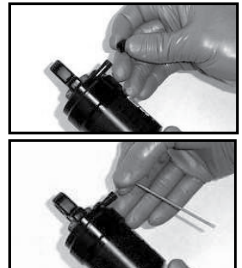

4. Clamp the eyelet at the air can end of the shock into a bench vise.
Note: Use aluminum vise "soft-jaws" to protect the shock eyelet when clamped.

4

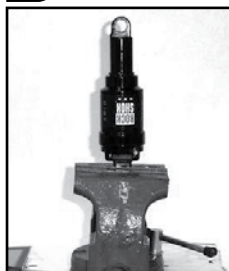

5

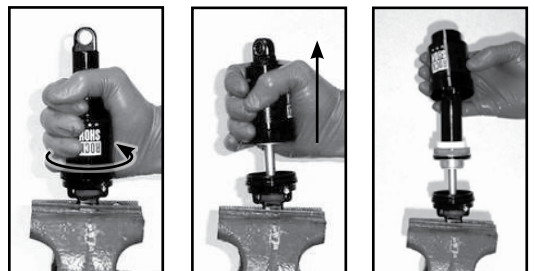

5. Grip the air can firmly by hand and turn it counter-clockwise to loosen and unthread it. Once it is completely unthreaded, slowly pull the air can along the shock damper body to remove it.
note: you may need to use a strap wrench to help unthread the air can. if possible, avoid placing the strap wrench on the logo sticker.

Important: Be careful not to clamp and damage any of the adjuster knobs.

Note: Vacuum pressure will increase as you pull the air can along the damper body, then suddenly release as the end of the can comes over the damper body eyelet.

6. Remove the negative spring spacer and negative spring bumper (the spacer may still be in the air can). Spray both with isopropyl alcohol and wipe them with a clean rag.
Important: Do not attempt to disassemble shock damper and/or shock eyelet assembly. They are not serviceable.

6

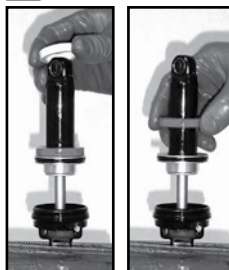

7

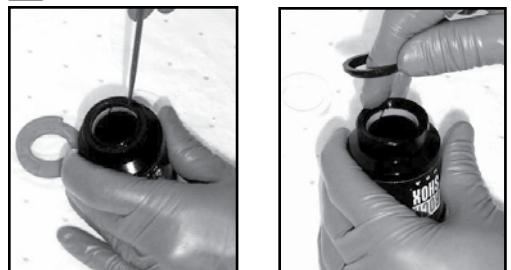

7. Use a sharp pick to remove the rubber dust wiper from the air can.

Note: Pierce the dust wiper with the pick and pull to remove it. Do not scoop or dig the dust wiper out as this may damage the air can sealing surface.

AIR CAN REMOVAL/SERVICE INSTRUCTIONS

8. Hold the air can, narrow end down, and use a sharp pick to remove the plastic glide ring from the air can.

Note: Pierce the glide ring with the pick and pull to remove it. Do not scoop or dig the glide ring out as this may damage the air can sealing surface.

9. Use your fingers to remove the air can outer o-ring located at the large diameter end of the air can. Apply a few drops of Pit-Stop suspension to the new o-ring and install it.
10. Spray isopropyl alcohol inside the air can and wipe it with a clean rag. Inspect the inside of the air can for any rough surfaces or scratches. Additionally, run your finger along the inside surface of the air can to feel for rough surfaces or scratches. Replace the air can if it is scratched or damaged.

11. Use a pick to remove the large fixed air piston o-ring. Apply a few drops of Pit-Stop suspension oil to the new o-ring and install.

Important: When using a pick to remove the o-ring, do not scratch the piston. Scratches may cause air to leak.

12. Install the new air can glide ring by gently compressing the glide ring so that it doubles over on itself slightly, then pushing the glide ring into the small side of the air can so that it rests on the second step just below the opening.

13. Orient the air can dust wiper so that the flat side faces toward the air can and the angled side faces away from the air can. Install the new dust wiper by gently squeezing it into the groove next to the glide ring at the small end of the air can.

14. Spray isopropyl alcohol on the air can threads and eyelet body threads and wipe them with a clean rag.

15. Apply a small amount of 5wt Pit-Stop suspension oil to the inside of the air can. Using your finger, spread and coat the entire inner air can surface with the oil. Re-apply a few drops of Pit-Stop suspension oil to the glide ring and rubber dust seal.

Important: Coating the inside of the air can with Pit-Stop suspension oil ensures lubrication of the air seals, which reduces friction and o-ring wear.



AIR CAN REMOVAL/SERVICE INSTRUCTIONS

16. Install the new negative spring bumper and the negative spring spacer onto the damper body.
17. Position the large side of the air can over the damper body eyelet. Firmly press the air can down onto the air piston and damper body until the air can and eyelet body threads make contact. Thread the air can clockwise onto the eyelet body threads. Tighten the air can onto the eyelet body as tightly as possible by hand.

Note: Ensure the outside of the air can is free from oil. This allows a better grip when tightening the air can onto the shock eyelet body.

18. Remove the shock from the vise and install it into a bike stand by clamping onto the air can. Use a 13mm open end wrench to tighten the air can eyelet to 7.3 N·m (65 in-lb).

Important: Inspect the bike stand clamp and remove any debris that could damage the air can decal. Clamp the air can firmly enough to prevent it from rotating, but not firmly enough to deform the air can. Deformation of the air can can cause a poor seal resulting in an air leak.

19. Apply a few drops of Pit-Stop suspension oil to the new valve core and use a Schrader valve tool to install it.
20. Use a shock pump to inflate the shock to the desired air pressure, then install the valve cap.
21. Spray isopropyl alcohol on the entire shock and wipe it with a clean rag.
22. Insert mounting hardware into both eyelets.

This concludes the spring service for your shock. You did a great job! You are now ready to re-install your shock onto your bike and go for a ride!

17

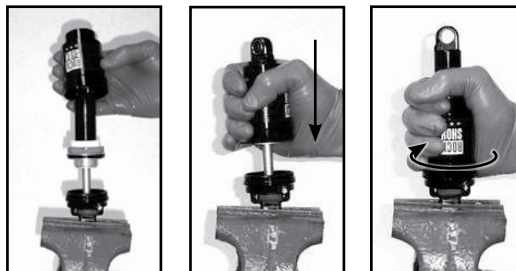

18

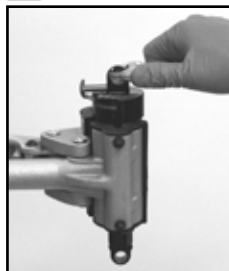

19



20



22



MOUNTING HARDWARE & BUSHING SERVICE (ARIO - MONARCH - VIVID)

Prior to servicing your rear shock, you will first need to remove it from your bicycle frame according to your bicycle manufacturer's instructions. Once your shock is off your bicycle, you will need to remove the mounting hardware before performing any service.

MOUNTING HARDWARE REMOVAL

Some mounting hardware is easily removed using only your fingers. Try to remove the end spacers with your fingernail, then push the bushing pin out of the bushing. If this works, move onto the next section titled "Bushing Service".

If you are unable to remove your mounting hardware using your fingers, use the RockShox rear shock bushing installation and removal tool.

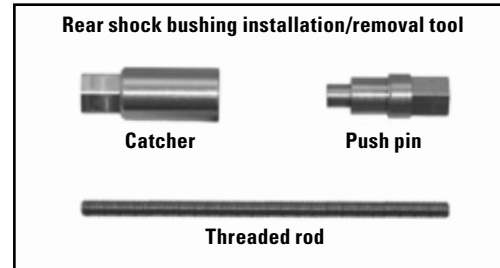

1. Thread the push pin onto the threaded rod, small diameter end first, until the rod is flush with or slightly protrudes from the hex-shaped end of the push pin.
2. Insert the threaded rod through the shock eyelet so that the push pin rests against the bushing pin.
3. Thread the catcher, opening side first, along the rod until it rests over the end spacer on the opposite side of the bushing pin.
4. Secure the catcher in a vise or hold it secure with a 13 mm or adjustable wrench. Use a 13 mm wrench to thread the push pin along the rod until it stops against the end spacer. Unthread the push pin from the threaded rod and remove the end spacer from that side.
5. Re-install the push pin onto the threaded rod and hand thread it along the rod until it rests against the bushing pin (inside the shock eyelet bushing) again. Use a 13 mm wrench to thread the push pin along the rod until it stops against the shock eyelet.
6. Unthread the catcher from the threaded rod. Remove the end spacer from the threaded rod and the bushing pin from the catcher. Remove the push pin and threaded rod from the shock. Set the mounting hardware aside until you have finished servicing your shock. Repeat for the other eyelet.

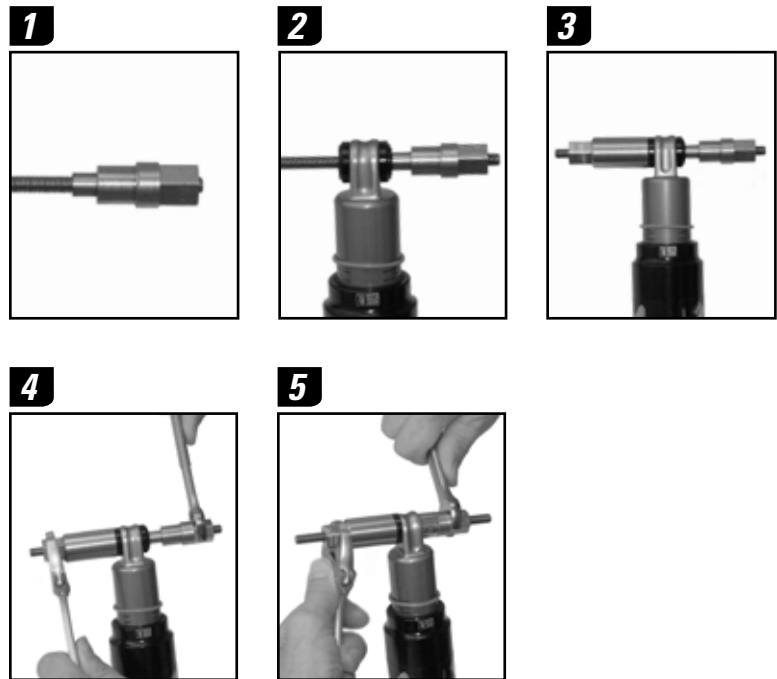

REAR SHOCK BUSHING SERVICE

To replace damaged or worn out bushings, use the RockShox rear shock bushing installation and removal tool.

Bushing removal

1. Insert the threaded rod through the shock eyelet so that the base of the push pin rests against the bushing.
2. Thread the catcher, opening side first, along the rod until it rests on the opposite side of the shock eyelet.
3. Secure the catcher in a vise or hold it secure with a 13 mm or adjustable wrench. Use a 13 mm wrench to thread the push pin along the rod until the push pin rests against the shock eyelet.
4. Unthread the catcher from the threaded rod. Remove the tool from the shock eyelet and discard the old bushing. Repeat for other eyelet.

Bushing installation

5. Apply a small amount of grease on the outside of the new bushing and slide it over the threaded rod so that it rests on the base of the push pin.
6. Insert the threaded rod through the shock eyelet until the bushing makes contact with the eyelet.
7. Thread the catcher down the rod until it rests against the opposite side of the eyelet.
8. Secure the catcher in a vise or hold it secure with a 13 mm or adjustable wrench.
9. Use a 13 mm wrench to thread the push pin along the rod, being careful to keep the bushing straight, until the bushing is seated and flush in the eyelet. Repeat for other eyelet.

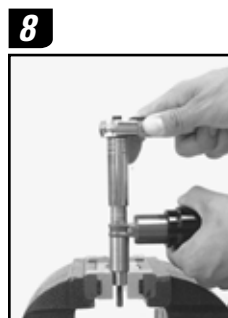
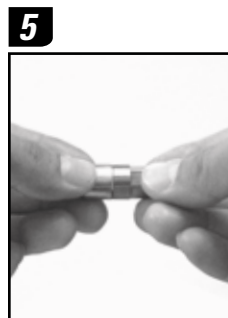

MOUNTING HARDWARE INSTALLATION

Some mounting hardware is easily installed using only your fingers. Try to press the bushing pin into the shock eyelet bushing until the pin protrudes from both sides of the eyelet an equal amount. Then press an end spacer, large diameter side first, completely onto each end of the bushing pin. If this works, you have completed mounting hardware and bushing service.

If you are unable to install your mounting hardware using your fingers, use the RockShox rear shock bushing installation and removal tool.

1. Thread the push pin onto the threaded rod, small diameter end first, until the rod is flush with or slightly protrudes from the hex-shaped end of the push pin.
2. Insert the threaded rod through the bushing pin then through the shock eyelet so that the bushing pin is positioned between the push pin and the shock eyelet.
3. On the opposite side of the shock eyelet, thread the catcher, opening side first, along the rod until it rests against the shock eyelet.
4. Secure the catcher in a vise or hold it secure with a 13 mm or adjustable wrench. Use a 13 mm wrench to thread the push pin along the rod so that it pushes the bushing pin into the shock eyelet bushing. Continue to thread the push pin and push the bushing pin into the shock eyelet bushing until the bushing pin protrudes from both sides of the eyelet an equal amount (you may need to unthread the catcher slightly to check the bushing pin spacing).
5. Unthread the catcher from the threaded rod and remove the tool from the shock eyelet.
6. Use your fingers to push an end spacer onto each end of the bushing pin, with the large diameter side of the spacers facing the shock eyelet.

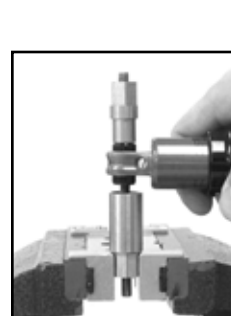

REAR SHOCK SERVICE (MONARCH/ARIO)

INTRODUCTION

Prior to servicing your rear shock, you will first need to remove it from your bicycle frame according to your bicycle manufacturer's instructions. Once your shock is off your bicycle, be sure to remove the shock mount hardware.

SERVICE INSTRUCTIONS

Getting started

Be sure to remove shock mounting hardware (see the "Mounting Hardware And Bushing Service" section).

Place an oil pan on the floor underneath the area where you will be working on the shock. Place a large oil absorbing rag directly underneath the vise where the shock will be clamped to catch all oil that will spill from the shock during service.

Turn the rebound adjuster fully counter-clockwise (toward the rabbit). Switch the Gate (if applicable) to the full open, unlocked, position.

Air can removal

1. Remove the swivel air valve cap. Use a small hex wrench or pick to depress the Schrader valve and release all air pressure from the air can. Use a Schrader valve tool to remove the valve core from the swivel valve.
2. Use a Schrader valve tool to remove the air/nitrogen port cap. Use a small hex wrench or pick to depress the Schrader valve and release all air/nitrogen pressure from the damper. Use a Schrader valve tool to remove the valve core.
3. Clamp the eyelet at the air can end of the shock into a bench vise, with the shock positioned sideways.

Note: Use aluminum vise "soft-jaws" to protect the shock eyelet when clamped.

Important: Be careful not to clamp and damage any of the adjuster knobs.

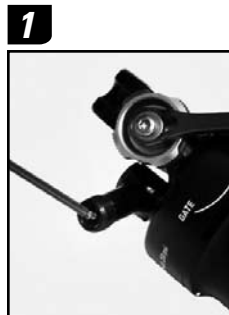

SERVICE INSTRUCTIONS (CONTINUED)

4. Grip the air can firmly by hand and turn it counter-clockwise to loosen and unthread it. Once it is completely unthreaded, slowly pull the air can along the shock damper body to remove it.

Note: For high volume air cans, grip the lower portion of the can. Otherwise the high volume sleeve will rotate independent of the air can preventing the air can from unthreading.

Note: You may need to use a strap wrench to help unthread the air can. If possible, avoid placing the strap wrench on the logo sticker.

Note: Vacuum pressure will increase as you pull the air can along the damper body, then suddenly release as the end of the can comes over the damper body eyelet.

5. Remove the negative spring bumper from inside the air can.

Shaft assembly service

6. Remove the shock from the vise, then re-install it into the vise at the damper end of the shock, with the shock positioned vertically.

Note: Use aluminum vise "soft-jaws" to protect the shock eyelet when clamped.

7. Using a 2 mm hex, unthread and remove the bleed screw, located in the seal head/fixed air piston.

Note: The compression ball may float up through bleed hole, this is ok. Simply remove the ball from the bleed hole. You will be able to skip step 9.

8. Using an adjustable wrench, loosen and remove the shaft/piston assembly from the shock body.

Note: Oil will spill from the damper body and/or shaft assembly.

9. Remove the shock from the vise. Hold the damper body eyelet with one hand, and push the seal head/fixed piston toward the air can eyelet body with your other hand to expose the bleed hole on the underside of the seal head.

Note: Be careful not to pinch your fingers as you slide the seal head/fixed piston.

10. Use a pick or 1.5 mm hex wrench to push and remove the compression ball out of the backside of the seal head through the bleed hole.

Note: Do not replace the compression ball at this time, you will do that later.

11. Spray the entire shaft and piston assembly with isopropyl alcohol and wipe it with a clean rag.

4

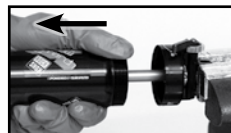

5

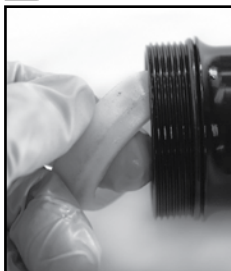

6



7



8



9



10



SERVICE INSTRUCTIONS (CONTINUED)

12. Use a pick to remove the seal head/fix piston outer glide ring, outer seal, and the piston glide ring. Apply a small amount of grease to the new seal head/fix piston outer glide ring, outer seal, and the piston glide ring and install.

12



13. Use a pick to remove the seal head/fix piston inner o-ring. Apply a few drops of Pit-Stop suspension oil to the new o-ring and install it.

Important: When using a pick to remove o-rings, do not scratch the seal head/fix piston. Scratches may cause oil to leak.

IFP and damper body service

14. Remove the damper body from the vise, and pour any remaining oil into the oil pan.
15. Wrap a rag around the end of the damper body. Thread a shock pump with the Monarch air fill adapter installed onto it into the air fill port, and force air into the damper body to force the internal floating piston (IFP) out of the end of the damper body, into the rag.

13



15

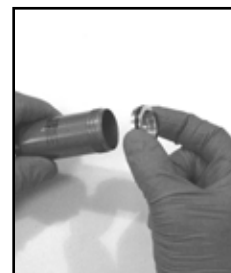

16. Spray isopropyl alcohol on the inside and outside of the shock body and wipe it with a clean rag. Inspect the inside and outside of the damper body for scratches. If scratches are found, the entire damper assembly will need to be replaced.

17



18



17. Use a pick to carefully remove IFP o-ring. Spray the IFP with isopropyl alcohol and wipe it with a clean rag. Apply a small amount of grease to the new o-ring and install.

Important: When using a pick to remove the o-ring, do not scratch the IFP. Scratches may cause air/oil to leak.

18. Insert the IFP into the damper body with the stepped side visible. Use a gauge tool to set the IFP height to the value indicated in the table below.

Important: Measure the IFP height from the bottom of the step on the IFP.

Damper body dimensions	IFP insertion depth
152x31	48 mm
165x38	54 mm
184x44	59 mm
190x51	65 mm
200x51	65 mm
200x57	70 mm
216x63	76 mm
222x66	78 mm

Shock reassembly

19. Using a Schrader valve core tool, install the new Schrader valve into the air fill port.
20. Clamp the damper body eyelet into the vise, with the damper body positioned vertically.
21. Pour new 7 wt Pit-Stop suspension oil into the damper body until it is level with the top of the damper body. Scrape any bubbles from the surface of the oil.

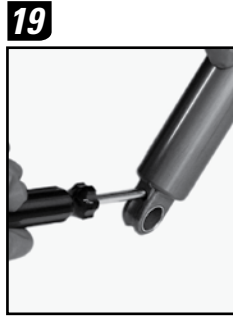

22. Check that both the gate and the rebound adjusters are in the full open/unlocked position. Insert the damper piston into the damper body until oil begins to flow from the hole in the damper shaft, just above the damper piston, then remove the damper piston from the damper body.



23. Pour 7 wt Pit-Stop suspension oil into the damper body until it is level with the top of the damper body again. Slide the seal head/fixed piston against the damper piston assembly, then, holding only the seal head/fixed piston, install the seal head/fixed piston onto the damper body and thread it completely onto the damper body.

Important: Do not hold on to the air can eyelet while inserting. It will move the piston/shaft assembly, causing too much oil to displace out of the damper body. The seal head/fixed piston must remain against the damper piston assembly for the remainder of the shock re-assembly procedure.

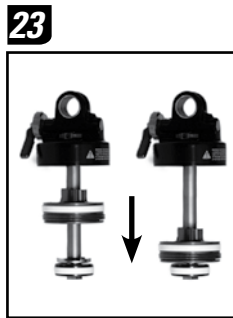

Note: Oil will displace out of the bleed hole.

24. Use a torque wrench with crow's foot to torque the seal head/fixed piston to 250 in-lb.

Important: Install the crow's foot onto the torque wrench at a 90° angle to the handle to ensure an accurate torque reading.

25. Insert the new compression ball into the bleed hole.

26. Use a 2.5 mm hex to gently thread the bleed screw into the bleed hole until you feel it touch the compression ball. Tighten the bleed screw an additional ½ turn.

Important: Tightening the bleed screw any more than a ½ turn can damage the compression ball, causing oil to leak.



27. Use a gauged pump with the Monarch air fill adapter to pressurize the damper body with air.

Shock	Pressure
Monarch	250 psi
Ario 1.1	250 psi
Ario 2.1	250 psi
Ario 3.2	500 psi

27



28

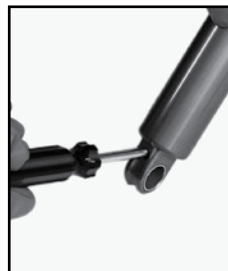

Important: Once you have pressurized the shock, remove the Monarch air fill adapter from the air fill port **BEFORE** removing it from the shock pump. Separating the pump from the adapter first will allow all of the air to escape from the shock.

Note: If you have the proper fill equipment, you may substitute air with nitrogen.

28. Use a Schrader valve tool to re-install the air fill port cap.
 29. Spray the damper assembly with isopropyl alcohol and wipe it with a clean rag.

30



Air can service and installation

30. Use your fingers to remove the air can outer o-ring located at the large diameter end of the air can. Apply a few drops of Pit-Stop suspension to the new o-ring and install it.
 31. Use a pick to remove the rubber dust wiper and the air seal from the air can.

Note: Pierce the seals with the pick and pull to remove them. Do not scoop or dig the seals out as this may damage the air can sealing surface.

31



32. Hold the air can, narrow end down, and use a sharp pick to remove the plastic glide ring from the air can.

Note: Pierce the glide ring with the pick and pull to remove it. Do not scoop or dig the glide ring out as this may damage the air can sealing surface.

32



34



33. Spray isopropyl alcohol inside the air can and wipe it with a clean rag. Inspect the inside of the air can for any rough surfaces or scratches. Additionally, run your finger along the inside surface of the air can to feel for rough surfaces or scratches. Replace the air can if it is scratched or damaged.

Note: High volume air cans have a port that you may feel during inspection. This is normal.

34. Install the new air can glide ring by gently compressing the glide ring so that it doubles over on itself slightly, then pushing the glide ring into the small end of the air can so that it rests on the second step just below the opening.



SERVICE INSTRUCTIONS (CONTINUED)

35. Apply a small amount of grease to the air can air seal. Install it into the small end of the air can, so that it rests on the first step just below the opening.

35



36. Orient the air can dust wiper so that the flat side faces toward the air can and the angled side faces away from the air can. Install the new dust wiper by gently squeezing it in between the air seal and the lip of the air can at the small end of the air can.

36



37. Spray isopropyl alcohol on the air can threads and eyelet body threads and wipe them with a clean rag.

38



38. Apply a small amount of 5wt Pit-Stop suspension oil to the inside of the air can. Using your finger, spread and coat the entire inner air can surface with the oil. Re-apply a few drops of Pit-Stop suspension oil to the glide ring, air seal, and rubber dust seal.

39

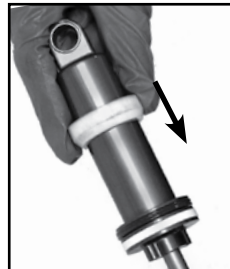

Important: Coating the inside of the air can with Pit-Stop suspension oil ensures lubrication of the air seals, which reduces friction and o-ring wear.

39. Install the negative spring bumper onto the damper body with the angled side of the bumper facing the seal head/ fixed piston.

40

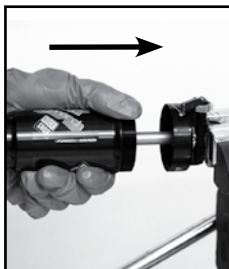

40. Position the large side of the air can over the damper body eyelet. Firmly press the air can down onto the air piston and damper body until the air can and eyelet body threads make contact. Thread the air can clockwise into the eyelet body threads. Tighten the air can into the eyelet body as tightly as possible by hand.



Note: Ensure the outside of the air can is free from oil. This allows a better grip when tightening the air can onto the shock eyelet body.

Note: For high volume air cans, grip the lower portion of the can. Otherwise the high volume sleeve will rotate independent of the air can preventing tightening of the air can.

SERVICE INSTRUCTIONS (CONTINUED)

41. Remove the shock from the vise and install it into a bike stand by clamping onto the air can.
Important: Inspect the bike stand clamp and remove any debris that could damage the air can decal. Clamp the air can firmly enough to prevent it from rotating, but not firmly enough to deform the air can. Deformation of the air can can cause a poor seal resulting in an air leak.

Note: For high volume air cans, remove the high volume sleeve and o-rings before clamping the can into the bike stand.

42. Use a 13mm open end wrench to tighten the air can eyelet to 11.2 N-m (100 in-lb).

Note: For high volume air cans, re-install the high volume o-rings and sleeve.

43. Monarch only: Inspect the swivel air valve for damage. If necessary, use a 7 mm open end wrench to loosen and remove the swivel valve. Apply a few drops of suspension oil to the o-ring and a drop of blue Loctite to the threads of the new swivel valve and install it. Tighten the swivel valve to 1.1 N-m (10 in-lbs).
44. Apply a few drop of Pit-Stop suspension oil to the new valve core and use a Schrader valve tool to install it into the swivel valve.
45. Use a shock pump to inflate the shock to the desired air pressure, then install the valve cap.
46. Spray isopropyl alcohol on the entire shock and wipe it with a clean rag.
47. Re-install shock mounting hardware (see the "Mounting Hardware And Bushing Service" section).

42



43



44

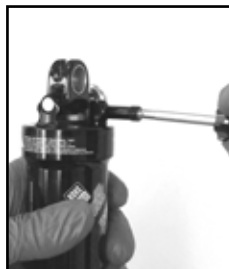

45



This concludes the service for your shock. You did a great job! You are now ready to re-install your shock onto your bike and go for a ride!

REAR SHOCK SERVICE (VIVID)

INTRODUCTION

Prior to servicing your rear shock, you will first need to remove it from your bicycle frame according to your bicycle manufacturer's instructions. Once your shock is off your bicycle, be sure to remove the shock mount hardware.

Vivid rear shock service includes instructions for completing both regular and full service procedures. Regular service procedures are maintenance items that should be completed routinely in order to keep your shock performing optimally. Full service procedures are long-term maintenance items that are performed in addition to the regular service items. For regular service intervals, you only have to perform the sections called out as 'Regular Service'. For full service intervals, you will complete all instructions, in order, including the regular service procedures.

SERVICE INSTRUCTIONS

Getting started

Be sure to remove the shock mounting hardware (see the "Mounting Hardware And Bushing Service" section).

Place an oil pan on the floor underneath the area of the shock. Place a large oil absorbing rag directly underneath the vise where the shock will be clamped to catch all oil that will spill from the shock during service.

Record the adjustment settings for post-service set-up.

Turn the Beginning Stroke Rebound and Ending Stroke Rebound adjustments to the full open position, toward the rabbit. Turn the Low Speed Compression adjustment to the full closed position, toward the turtle.

Spring removal (regular service)

1. Turn the pre-load collar counter-clockwise until it stops.
2. Remove the spring retainer, spring and drop stop. Set aside the parts until the Shock Bleed & Reassembly section.

Note: The Drop Stop houses a bumper which will not be removed from the shock.

Shock body disassembly (regular service)

3. Clamp the shock by body eyelet into a vise. **note: use aluminum vise "soft jaws" to protect the shaft eyelet when clamped.**
4. Using a T10 TORX® wrench, remove the internal floating piston (IFP) reservoir cap from the IFP reservoir and discharge the air by depressing the valve. Using a Schrader valve tool, remove the Schrader valve core.

Important: Be sure to completely discharge the IFP reservoir to avoid personal injury during disassembly.

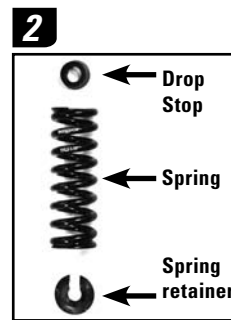
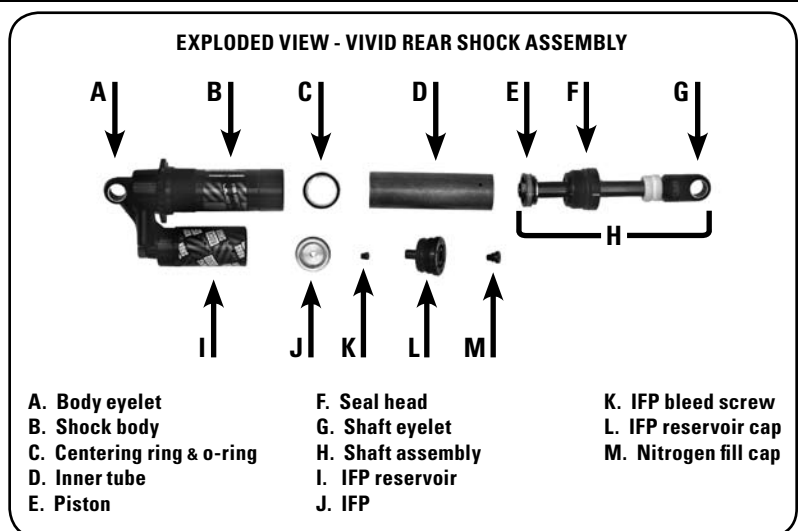

SERVICE INSTRUCTIONS (CONTINUED)

5. Using the RockShox 24 mm pin spanner, unthread the seal head.

Important: Hold the pin spanner head in place with your opposite hand during use to avoid damaging the seal head pin holes.

6. Pull up on the seal head and remove the entire shaft assembly.
Note: The shock body inner tube may become dislodged with the shaft assembly; this is ok. If this occurs, simply separate the shaft assembly from the inner tube and remove the inner tube from the shock body.

7. Use your fingers to remove inner tube from the shock body.

8. Remove the shock from the vise and pour all oil from the shock into the oil pan.

9. Confirm that the centering ring, located in the bottom of the shock body, is still in place.
Note: The centering ring may become dislodged when removing the inner tube, this is ok. If this occurs, simply remove it from the inner tube or the shock body.

10. Clamp a pick into the vise. Slide the shock body over the pick. Using the pick as a hook, hook the bottom of the centering ring and pull back on the shock body to dislodge the centering ring. You may have to hook the pick around the centering ring in several places in order to dislodge.
Important: Do not to scratch the bottom of the shock body with the pick; this is the sealing surface. Damage to this surface will interfere with the performance of the shock.

Shock body shaft assembly service (regular service)

11. Spray the shaft assembly with isopropyl alcohol and wipe it with a clean lint-free rag.
 12. Use the RockShox shaft clamp tool to clamp the shaft assembly into the vise.
Note: Spray isopropyl alcohol on the shaft clamp and wipe it with a clean rag prior to use.
 13. Use a pick to remove the glide ring on the main piston. Apply a small amount of grease to the new glide ring and install it.
 14. Use a 13 mm wrench to unthread the piston bolt. Carefully remove the main piston assembly (piston bolt, main piston, and shim stack washers), keeping all parts together and set it aside.
 15. Firmly pull up on the seal head to remove it.

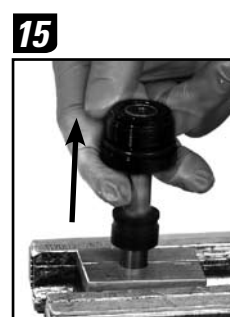
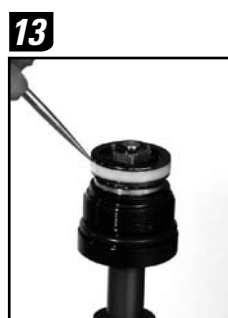
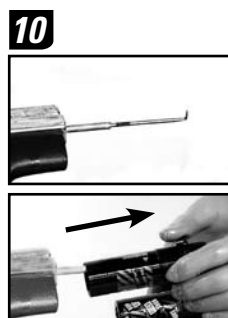
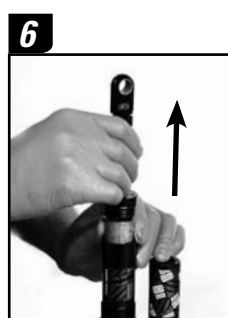
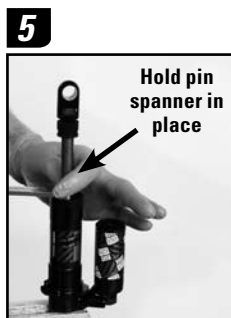

16. Use a pick to remove the shaft wiper seal and main shaft o-ring located in the interior of the seal head. Remove the o-ring top out pad located on the backside of the side head. Apply a small amount of grease to the new shaft wiper seal, main shaft o-ring and quad ring top out pad and install them into the seal head.
17. Inspect the body seal o-ring located on the underside lip of the seal head for wear or damage. Replace it if necessary.
18. Set the seal head and main piston assembly aside.

16



17



Eyelet service

19. Flip the shaft assembly in the shaft clamp so that the shaft eyelet is accessible. Use a 13 mm wrench to unthread the eyelet and remove it.
20. Clean all Loctite from the threads of the shaft eyelet.
21. Use a pick to carefully push the red Beginning Stroke Rebound Adjuster knob out of the shaft eyelet.

19



Note: The beginning stroke rebound adjuster knob houses the detent ball and spring. Be careful not to lose these parts.

22. Use a pick to remove the Beginning Stroke Rebound Adjuster knob o-ring. Apply a small amount of grease to the new o-ring and install it.
23. Use a crescent wrench to unthread the rebound needle and remove it.

21

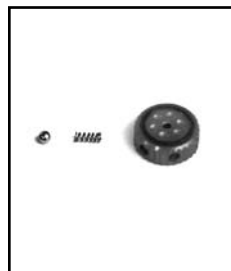

22

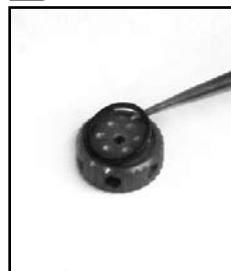

Important: Be very careful not to damage the hex-shaped portion of the rebound needle with the crescent wrench.

24. Use a pick to remove the rebound needle o-ring. Apply a small amount of grease to the new o-ring and install it. Set aside the rebound needle.
25. Carefully insert the detent spring followed by the detent ball into to the offset hole in the shaft eyelet. Slide the rebound knob, with the detent features interfacing with the detent ball, back into the shaft eyelet. Set aside the shaft eyelet.

23

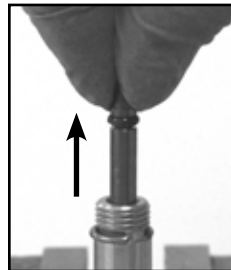

24

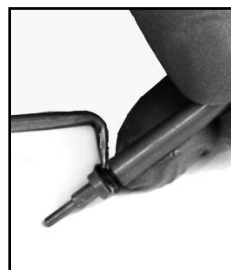

Shock body shaft assembly service (regular service)

26. Clamp the shaft assembly so that the rebound bleed port is accessible. Grease the interior of the seal head and install it onto the shaft assembly with the seal head threads oriented upward.

25



26



Important: Make sure the shaft wiper seal does not fold over when installing the seal head.

27. Use a 14 mm wrench to thread the piston assembly back onto the shaft assembly and torque it to 7.9 N·m (70 in-lb).
28. Flip the shaft assembly in the shaft clamp so that the shaft eyelet threads are exposed. Insert the rebound needle into the rebound shaft. While pushing down on the needle, thread it into the shaft by hand until it stops.
29. Clean the shaft assembly threads with isopropyl alcohol. Apply a thin layer of red Loctite to the shaft threads.

Important: Be sure the loctite does not get between the rebound needle and shaft. It will prevent the needle from moving.

30. Clean the shaft eyelet threads with isopropyl alcohol.
31. Hold the shaft eyelet assembly by the eyelet and thread it onto the shaft.

Important: Do not hold the beginning stroke rebound knob while threading the shaft eyelet assembly.

After approximately 4 full turns, you will hear an audible clicking sound, indicating the rebound needle has engaged the adjuster knob. Continue to thread the shaft eyelet assembly by hand until it is tight. Use a 13 mm wrench to torque it to 14.6 N·m (130 in-lb).

32. Remove the shaft assembly from the vise and set it aside until you get to the Shock Bleed & Reassembly section.

IFP reservoir & low speed compression valve service

IFP reservoir service (regular service)

33. Clamp the shock body by the body eyelet into the vise. Use a 30 mm flat wrench at the base of IFP reservoir (to keep the reservoir from spinning) and a 24 mm pin spanner wrench on the top of the reservoir to unthread the IFP seal head cap and remove it.

Important: Hold the pin spanner head flat against the seal head cap during use to avoid damaging the pin holes.

34. Use a pick to remove the IFP seal head o-ring. Apply a few drops of Pit-Stop suspension oil to the new o-ring and install it.
35. Use a 30 mm flat wrench at the base of the IFP reservoir to unthread and remove the IFP reservoir.

Note: The IFP may become dislodged from the IFP reservoir; this is ok. If this occurs, simply remove the IFP from the IFP reservoir.

36. Use your finger to push the IFP out of the IFP reservoir from the backside.

27



28

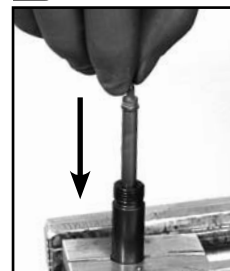

29



31



33



34



35



36



SERVICE INSTRUCTIONS (CONTINUED)

37. Use a pick to remove the glide ring and main seal quad-ring from the IFP. Apply a small amount of grease to the new glide ring and o-ring and install it.
38. Use a T10 TORX® to remove the IFP bleed screw. Use a pick to remove the IFP bleed screw o-ring. Apply a small amount of grease to the new o-ring and install it.
39. Set aside the IFP reservoir, IFP, and IFP bleed screw until you get to the Shock Bleed & Reassembly section.

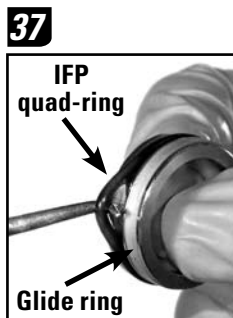

- Low speed compression valve service**
40. Use a 2 mm hex to loosen the low speed compression knob set screw. Remove the low speed compression knob.
 41. Squeeze the Low Speed Compression valve assembly between your fingers, and carefully push it up and out of the IFP reservoir base.
Note: Continue to squeeze the compression valve assembly together as you remove; it houses the detent ball and spring. Once it is removed, set the assembly aside, being careful not to lose these parts.

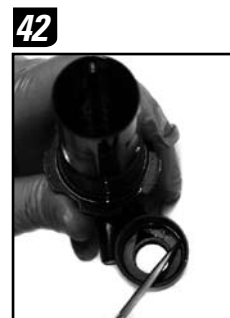

42. Use a pick to remove the IFP base o-ring. Apply grease to the new o-ring and install it.
43. Separate the inner knob and detent ball and spring from the Low Speed Compression valve assembly. Slide the shim check spring off the valve assembly.
44. Use your fingers to unthread the compression needle from the back of the Low Speed Compression valve assembly.
45. Inspect the check shim for damage and replace it if necessary.



- Important: If the check shim needs to be replaced, do not use a pick to remove it. Instead, use your fingernail to avoid damaging the valve sealing surface.**
46. Remove the Low Speed Compression valve main o-ring, compression piston o-ring, and compression needle o-ring. Apply grease to the new main, compression, and needle o-rings and install them.
 47. Remove the shock from the vise and pour out any remaining oil. Clamp the shock by the body eyelet back into vise.
 48. Use your fingers to thread the compression needle back into the Low Speed Compression valve assembly.
 49. Slide the shim check spring onto the piston assembly. Using a dab of grease to hold parts together, insert the detent spring followed by the detent ball into the inner knob.

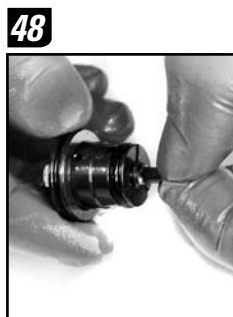
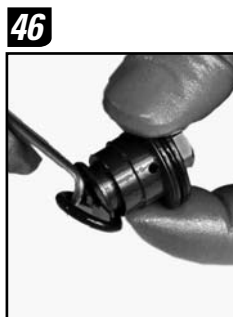

SERVICE INSTRUCTIONS (CONTINUED)

50. Install the inner knob onto the compression needle and hold the entire assembly together by squeezing it between your fingers.

51. Carefully insert the Low Speed Compression valve assembly into the shock body, inner knob first.

Tip: Use your little finger to help guide the low speed compression valve assembly into place.
Important: Make sure the low speed compression valve assembly is fully seated. Be careful not to damage the main o-ring.

52. Hand thread the IFP reservoir onto the shock body until it is tight.

Important: Make sure there is no gap between the IFP reservoir and the shock body.

53. Use a 2 mm hex to re-install the low speed compression knob.

Ending stroke rebound service

54. Clamp the shock into the vise sideways by the body eyelet so that the Ending Stroke Rebound adjuster is easily accessible. Use a 2.5 mm hex to turn the Ending Stroke Rebound adjuster five clicks from fully open.

55. Use a pick to remove the Ending Stroke Rebound retaining ring.

56. Use a 2.5 mm hex to unthread and remove the Ending Stroke Rebound adjuster screw.

Important: The ending stroke rebound adjuster consists of two detent balls, the detent spring, high speed rebound coil spring and plug, and two shims. Separate, but do not lose these parts.

57. Use a pick to remove the Ending Stroke Rebound adjuster screw o-ring. Apply grease to the new o-ring and install it.

58. Using dabs of grease to hold the parts together, install the rebound adjuster screw onto a 2.5 mm hex wrench held upright, then install the rebound coil onto the adjuster screw, followed by the plug, the 6 mm shim, and the 7mm shim. Install the small detent spring into the adjuster screw, then using dabs of grease to hold them in place, install a detent ball onto each side of the detent spring inside the adjuster screw. Apply a dab of grease onto the outer surfaces of the detent balls to hold them in place in the adjuster screw.

50



51



52



53



54



55



56



57



58

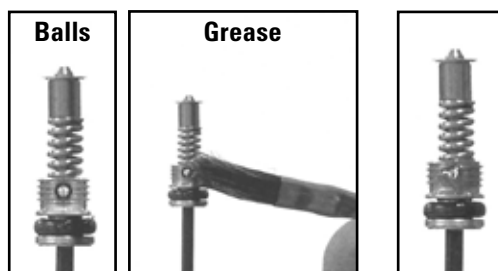
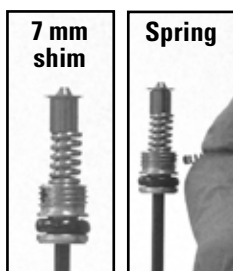
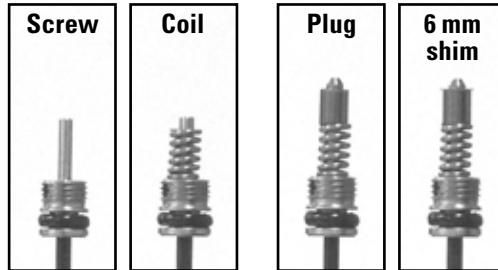

59. Remove the shock from the vise. Clamp the 2.5 mm wrench, with the High Speed Rebound adjuster assembly still installed onto it, upright in the vise. With one hand, lower the shock body down over the High Speed Rebound adjuster assembly to install the assembly into the rebound adjuster cavity. Use the thumb and fore finger of your other hand to hold the two detent balls inside the rebound adjuster screw as the rebound adjuster assembly enters the shock body. Once the detent balls are inside of the shock body, remove the assembled rebound assembly/shock body from the 2.5 mm hex, and rotate the shock body so that the rebound adjuster screw faces upward.

59

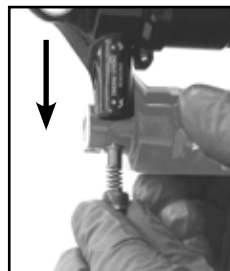
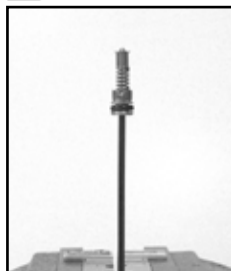

60. Remove the 2.5 mm hex from the vise and use it to thread the rebound screw into the shock body until it stops. All parts are properly seated when you hear 'clicking' sounds.

60

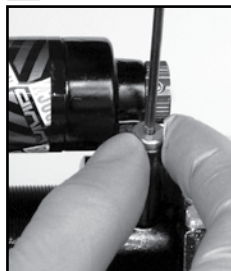

61



Important: You don't want to feel the parts binding as you thread adjuster screw into place. It should remain smooth until it starts to click. If the parts bind, it means one of the detent balls came unseated and you will need to disassemble the Ending Stroke Rebound assembly and repeat the last two steps.

61. Use your fingers to re-install the Ending Stroke Rebound retaining ring. Insert one end of the retaining ring into its groove, then press around the ring to seat it completely.

62

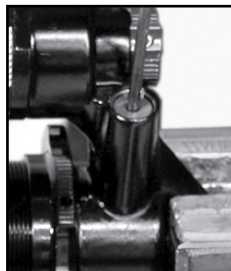

63

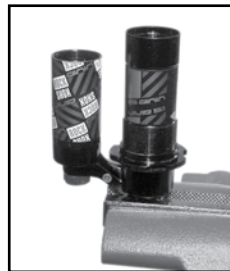

62. Use a 2.5 mm hex to turn the Ending Stroke Rebound adjuster fully counter-clockwise, toward the rabbit, to ensure the retaining ring is fully seated. Leave it in this position for the remainder of the shock service.

64



Shock bleed & re-assembly procedures (regular service)

63. Clamp the shock by the body eyelet into the vise so that the shock body and IFP reservoir are accessible.

64. Grease the o-ring groove of the Centering Ring and install the new face seal crush washer, smoothing grease over the o-ring to keep it in place. Using the inner tube as a push rod, press the Centering Ring, o-ring side down, into the bottom of the shock body.

Important: Make sure the o-ring stays in its groove as you insert the Centering Ring into the shock body. Otherwise, the damper will not seal properly, resulting in poor damping performance.

SERVICE INSTRUCTIONS (CONTINUED)

65. **5.1 only:** Turn the Low Speed Compression Knob fully counter-clockwise, away from "+" sign (not pictured).

65



66. Use 3wt Pit-Stop suspension oil to fill the IFP reservoir to the top. Oil will gradually flow from the IFP reservoir into the shock body through the small port located at the bottom of the IFP reservoir. Continue to fill the IFP reservoir until the oil level in the shock body reaches approximately 25 mm from the bottom of the inside of the shock body.

66



67



67. Begin the reverse process of pouring oil into the shock body. Oil will begin to flow from the shock body into IFP reservoir. Continue until oil starts to overflow out of the IFP reservoir. This procedure effectively dislodges air bubbles from the system. Top off the oil in the shock body in order to continue oil flow from the shock body to the IFP reservoir (oil will continue to overflow from the IFP reservoir, this is normal).

68



68. Gently slide the IFP, stepped side down, into the top of the IFP reservoir. Let the IFP 'float' on top of the oil in IFP reservoir.

69. Cover and seal the bleed hole on the IFP with your thumb or finger and push the IFP down into the IFP reservoir approximately 12 mm.

69



70. Top off the oil in the shock body again in order to continue oil flow from the shock body to the IFP reservoir.

70



71



Important: Wait for the oil to overflow from the IFP reservoir before continuing.

71. Use the T10 TORX® wrench to install the IFP bleed screw. Tighten the screw until the IFP spins.

72. Using the T10 TORX® wrench inserted into the bleed screw as a push rod, firmly push the IFP down into IFP reservoir until it stops at the bottom of the IFP reservoir.

72



73. Insert the shock body inner tube into the shock body with the cross holes oriented up toward the top of the shock body.

73



Important: It is critical that the cross holes are oriented properly.

74. Gently wiggle the inner tube side to side against the shock body with your finger to dislodge any air bubbles that may be trapped between the inner tube and the shock body inner surface.

74



SERVICE INSTRUCTIONS (CONTINUED)

75. Top off the oil in the shock body one last time.
76. Seat the seal head fully against the piston on the shaft assembly. Place the piston into the oil on top of the shock body at a 45 degree angle. Rotate the shaft/piston assembly 2-3 times to fill any cavities in the piston assembly with oil. Continue to rotate the shaft assembly as you align it vertically, then gently insert the assembly into the shock body. This process minimizes trapped air during the assembly process.

75



77. Hold the shaft assembly by the seal head and **slowly** thread the seal head onto the shock with your fingers. Trapped air and oil should escape through the notch in the seal head threads. **Important: Do not push on the shaft or shaft eyelet. This will displace more oil than is necessary at this time.** **Important: Be sure to perform this step slowly, allowing oil and air to escape through the notch.**

76



78. Continue to thread the seal head down until the seal head o-ring contacts the shock body. Use the 24 mm pin spanner tool to torque the seal head to 28.2 N-m (250 in-lb).

77



78



Note: Firmly hold the 24 mm pin spanner in place with one hand while torquing with the other.

Important: The torque wrench should be attached at a 90° angle to the 24 mm pin spanner tool in order to obtain an accurate torque reading.

79. Remove the shock from the vise and pour out any remaining oil in the IFP reservoir, above the IFP.

79



80



80. Clamp the shock back into the vise at the body eyelet. Install the IFP reservoir seal head onto the IFP reservoir, and hand thread until the o-ring contacts the reservoir housing. Use the 24 mm pin spanner tool to torque the seal head to 11.2 N-m (100 in-lb).

Important: The torque wrench should be attached at a 90° angle to the 24 mm pin spanner tool in order to obtain an accurate torque measurement.

SERVICE INSTRUCTIONS (CONTINUED)

81. Install the Vivid air adapter onto a gauged pump, and charge the IFP chamber to:

Shock Model	Pressure
Vivid 5.1	200psi (13.8 bar)
Vivid 4.1	230psi (15.9 bar)

Important: Once you have pressurized the shock, remove the VIVID air fill adapter from the air fill port BEFORE removing it from the shock pump. Separating the pump from the adapter first will allow all of the air to escape from the shock.

82. Use a T10 TORX® wrench to install the IFP end cap onto the reservoir.
83. Spray the entire shock with isopropyl alcohol and wipe it with a clean rag.
84. Re-install the Drop Stop bumper, coil spring, spring retainer, and shock mounting hardware (see the "Mounting Hardware And Bushing Service" section).

This concludes the service for your shock. You did a great job! You are now ready to re-install your shock onto your bike and go for a ride!

81



82



www.sram.com

WORLD HEADQUARTERS

SRAM, LLC
1333 N. Kingsbury St., 4th Fl
Chicago, IL 60642
USA
Phone +1-312-664-8800
Fax +1-312-664-8826

EUROPEAN HEADQUARTERS

SRAM Europe
Basicweg 12-d
3821 Br Amersfoort
The Netherlands
Phone +31-33-450-6060
Fax +31-33-457-0200

ASIAN HEADQUARTERS

SRAM Taiwan
No. 1598-8 Chung Sahn Rd
Shen Kang Hsiang, Taichung
County 429 Taiwan R.O.C.
Phone +886-4-2564-3678
Fax +886-4-2561-3686