



2007 ROCKSHOX TECHNICAL MANUAL (ENGLISH)

Part# 95-4015-011-000, Rev. B

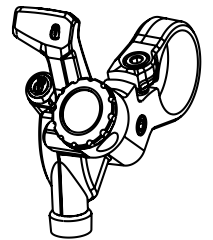
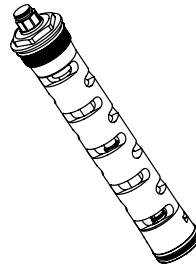
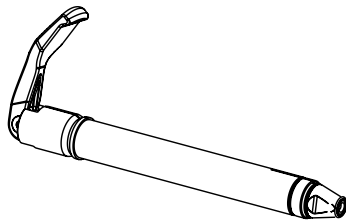

TABLE OF CONTENTS

Getting Started Information	5
Fork Technology Designation.....	6
Tools Needed for Service.....	8
Oil Volumes.....	10
Lower Leg Removal (All Forks)	13
Bushing Service (All Forks)	15
Damper Service	25
Rebound & Turnkey	
(Dart 2, 2 with Turnkey, 3 - Domain 302 - Recon 335 - Tora 289, 302).....	26
Motion Control	
(Argyle 318, 409 - Domain 318 - Tora 318).....	29
Motion Control	
(BoXXer Race, Team, WC - Pike 409, 426 - Reba SL, Race, Team, WC - Recon 351 - Revelation 409, 426).....	32
Motion Control	
(SID Team, WC).....	35
Pure Delite	
(SID Race).....	39
Mission Control	
(Lyrik - Totem).....	41
Spring Service	45
Coil	
(Argyle 302, 318 - Dart 1, 2, 2 (with Turnkey), 3 - Domain 302, 318 - Tora 289, 302, 318).....	46
Coil	
(BoXXer Race, Team - Recon 327, 335, 351 - Totem).....	47
Coil U-Turn	
(Domain 302, 318 - Tora 289, 302, 318).....	48
Coil U-Turn	
(Lyrik - Pike 409, 426, 454 - Recon 327, 351 - Revelation 426).....	49
Solo Air	
(Argyle 409, Recon 335, 351 - Tora 318).....	50
Solo Air	
(BoXXer WC - Lyrik - Recon 327, 335, 351 - Totem).....	53
Dual Air	
(Pike 409, 426 - Reba SL, Race, Team, WC - Revelation 409, 426).....	56
Air U-Turn	
(Pike 409, 429 - Reba Race, Team - Revelation 409, 429).....	60
2-Step Air	
(Lyrik - Totem).....	64
Lower Leg Installation (All Forks)	67
Rear Shock Service (All Shocks)	71



SAFETY FIRST!

At SRAM Corporation, we care about YOU, our customer. Please, **ALWAYS** wear your safety glasses when servicing your RockShox fork. There are just too many trails to ride, vistas to summit and sunrises to see. **Protect your eyes! Wear your safety glasses!**

GETTING STARTED INFORMATION



For exploded diagrams and part number information, please refer to the Spare Parts Catalog, which is available on our website at www.rockshox.com

For ordering information, please contact your local distributor or visit our website at www.rockshox.com.

Information contained in this publication is subject to change at anytime without prior notice. For the latest technical information, please visit our website at www.rockshox.com. Product names used in this manual may be trademarks or registered trademarks of others.

© SRAM CORPORATION • 2007 ROCKSHOX TECHNICAL MANUAL

FORK TECHNOLOGY DESIGNATION (ALL FORKS)

The following chart is a complete list of the 2007 RockShox fork line-up. It details the fork model and corresponding damper and spring technology specific to each fork. It is important to determine the technology used in your fork, in order to successfully service it, as this manual is sectioned by technology, rather than forks. If you are unsure of the technology used in your fork, consult your local RockShox dealer for assistance.

FORK MODEL	DAMPER TECHNOLOGY					SPRING TECHNOLOGY					
	REBOUND ONLY	TURNKEY	MOTION CONTROL	PURE DELITE	MISSION CONTROL	COIL	COIL U-TURN	SOLO AIR	DUAL AIR	AIR U-TURN	2-STEP
ARGYLE 302	X					X					
ARGYLE 318			X			X					
ARGYLE 409			X					X			
BOXXER RACE			X			X					
BOXXER TEAM			X			X					
BOXXER WORLD CUP (WC)			X					X			
DART 1						X					
DART 2 (WITH TURNKEY)		X				X					
DART 2	X					X					
DART 3		X				X					
DOMAIN 302	X					X					
DOMAIN 302 COIL U-TURN	X						X				
DOMAIN 318			X			X					
DOMAIN 318 COIL U-TURN			X				X				
LYRIK COIL U-TURN					X		X				
LYRIK SOLO AIR					X			X			
LYRIK 2-STEP					X						X
PIKE 409 COIL U-TURN			X				X				
PIKE 409 AIR U-TURN			X							X	
PIKE 409 DUAL AIR			X						X		
PIKE 426 COIL U-TURN			X				X				
PIKE 426 AIR U-TURN			X							X	
PIKE 426 DUAL AIR			X						X		
PIKE 454 DUAL AIR			X						X		
PIKE 454 COIL U-TURN			X				X				
PIKE 454 AIR U-TURN			X							X	
REBA SL			X						X		
REBA RACE			X						X		
REBA RACE AIR U-TURN			X							X	
REBA TEAM			X						X		
REBA TEAM AIR U-TURN			X							X	
REBA WORLD CUP (WC)			X						X		
RECON 327 SOLO AIR	X							X			
RECON 335		X				X					
RECON 335 SOLO AIR		X						X			
RECON 351			X			X					
RECON 351 COIL U-TURN			X				X				
RECON 351 SOLO AIR			X					X			

FORK TECHNOLOGY DESIGNATION (CONT)

FORK MODEL	DAMPER TECHNOLOGY					SPRING TECHNOLOGY					
	REBOUND ONLY	TURNKEY	MOTION CONTROL	PURE DELITE	MISSION CONTROL	COIL	COIL U-TURN	SOLO AIR	DUAL AIR	AIR U-TURN	2-STEP
REVELATION 409 DUAL AIR			X						X		
REVELATION 409 AIR U-TURN			X							X	
REVELATION 426 DUAL AIR			X						X		
REVELATION 426 COIL U-TURN			X				X				
REVELATION 426 AIR U-TURN			X							X	
SID RACE				X					X		
SID TEAM			X						X		
SID WORLD CUP			X						X		
TOTEM COIL					X	X					
TOTEM SOLO AIR					X			X			
TOTEM 2-STEP					X						X
TORA 289	X					X					
TORA 289	X						X				
TORA 302		X				X					
TORA 302		X					X				
TORA 318			X			X					
TORA 318			X				X				
TORA 318			X					X			

TOOLS NEEDED FOR SERVICE (ALL FORKS)

The following chart is a list of the model year 2007 tools needed for service on your RockShox fork. While this chart is intended to be comprehensive, it is still only a guide. The tools required for each step of service are detailed in the text of each service section. Keep in mind your specific fork may not require every tool listed.

TOOLS	LOWER LEG REMOVAL	BUSHING SERVICE	DAMPER SERVICE	SPRING SERVICE	LOWER LEG INSTALLATION	REAR SHOCK SERVICE
SAFETY/STARTING EQUIPMENT						
SAFETY GLASSES	X	X	X	X	X	X
APRON	X	X	X	X	X	X
RUBBER GLOVES	X	X	X	X	X	X
CLEAN RAGS (LINT FREE)	X	X	X	X	X	X
OIL PAN	X	X	X	X	X	X
CLEAN WORK AREA	X	X	X	X	X	X
BICYCLE STAND	X		X	X	X	
BENCH VICE		X				X
WRENCHES/PLIERS						
1.5MM HEX			X			
2MM HEX				X		
2.5MM HEX			X	X	X	
4MM HEX	X ¹		X ²		X ¹	
5MM HEX	X				X	
10MM SOCKET OR OPEN ENDED WRENCH	X				X	
15MM SOCKET				X		
24MM SOCKET			X	X		
24MM THIN WRENCH			X ²			
TORQUE WRENCH			X	X		
SLIP JOINT PLIERS			X ²			X
SNAP RING PLIERS - INTERNAL			X	X		
SNAP RING PLIERS - EXTERNAL			X	X		
MISC TOOLS						
PLASTIC MALLET	X	X	X	X	X	
MALLET DRIFT TOOL		X				
LONG DOWEL ROD (PLASTIC OR WOOD)	X	X	X	X	X	
FLATHEAD SCREWDRIVER		X		X		
SHARP PICK			X	X		X
SHOCK PUMP			X ³	X	X	X
MAGNET				X		
RULER			X ³		X ¹	
SID DUAL AIR UPPER TUBE RETAINER TOOL				X ⁴		
BUSHING REMOVAL TOOL/PLATE		X				

¹BoXXer Only

²Mission Control Only

³SID Race Only

⁴SID Models Only

TOOLS NEEDED FOR SERVICE (CONT)

TOOLS	LOWER LEG REMOVAL	BUSHING SERVICE	DAMPER SERVICE	SPRING SERVICE	LOWER LEG INSTALLATION	REAR SHOCK SERVICE
OIL/LIQUIDS						
2.5, 5, 10 OR 15WT SUSPENSION OIL		X	X	X	X	X
GREASE		X	X	X	X	
OIL MEASURING DEVICE		X	X	X	X	X
ISOPROPYL ALCOHOL	X	X	X	X	X	X
BLUE THREADLOCK						X
COLD FROSTY BEVERAGE	X	X	X	X	X	X

OIL VOLUMES (ALL FORKS)

The following chart is a complete list of the model year 2007 RockShox fork line-up. It details the oil volume and weight for each fork leg.

FORK MODEL	RIGHT LEG (DAMPER)				LEFT LEG (SPRING)			
	TOP		BOTTOM		TOP		BOTTOM	
	VOLUME (CC/ML)	OIL WT	VOLUME (CC/ML)	OIL WT	VOLUME (CC/ML)	OIL WT	VOLUME (CC/ML)	OIL WT
ARGYLE 302	130	5	10	15	-	-	30	15
ARGYLE 318	130	5	10	15	-	-	30	15
ARGYLE 409	130	5	10	15	6	15	15	15
BOXXER RACE	150	5	15	15	30	15	-	-
BOXXER TEAM	150	5	15	15	30	15	-	-
BOXXER WORLD CUP (WC)	150	5	15	15	6	15	15	15
DART 1	-	-	20	15	-	-	20	15
DART 2 (WITH TURNKEY)	93	5	10	15	-	-	20	15
DART 2	150	5	-	-	-	-	20	15
DART 3	93	5	10	15	-	-	20	15
DOMAIN 302	200	5	10	15	-	-	15	15
DOMAIN 302 COIL U-TURN	200	5	10	15	-	-	15	15
DOMAIN 318	200	5	10	10	-	-	15	15
DOMAIN 318 COIL U-TURN	200	5	10	10	-	-	15	15
LYRIK COIL U-TURN	112	5	15	15	-	-	15	15
LYRIK SOLO AIR	112	5	15	15	6	15	15	15
LYRIK 2-STEP	112	5	15	15	40	2.5	10	15
PIKE 409 COIL U-TURN	120	5	15	15	-	-	15	15
PIKE 409 AIR U-TURN	120	5	15	15	6	15	15	15
PIKE 409 DUAL AIR	120	5	15	15	6	15	15	15
PIKE 426 COIL U-TURN	120	5	15	15	-	-	15	15
PIKE 426 AIR U-TURN	120	5	15	15	6	15	15	15
PIKE 426 DUAL AIR	120	5	15	15	6	15	15	15
PIKE 454 DUAL AIR	120	5	15	15	6	15	15	15
PIKE 454 COIL U-TURN	120	5	15	15	-	-	15	15
PIKE 454 AIR U-TURN	120	5	15	15	6	15	15	15
REBA SL	110	5	15	15	6	15	15	15
REBA RACE	110	5	15	15	6	15	15	15
REBA RACE AIR U-TURN	110	5	15	15	6	15	15	15
REBA TEAM	110	5	15	15	6	15	15	15
REBA TEAM AIR U-TURN	110	5	15	15	6	15	15	15
REBA WORLD CUP (WC)	110	5	15	15	6	15	15	15
RECON 327 SOLO AIR	120	5	15	15	6	15	15	15
RECON 335	120	5	15	15	-	-	30	15
RECON 335 SOLO AIR	120	5	15	15	6	15	15	15
RECON 351	118	5	15	15	-	-	30	15
RECON 351 COIL U-TURN	118	5	15	15	-	-	30	15
RECON 351 SOLO AIR	118	5	15	15	6	15	15	15

OIL VOLUMES (CONT)

FORK MODEL	RIGHT LEG (DAMPER)				LEFT LEG (SPRING)			
	TOP		BOTTOM		TOP		BOTTOM	
	VOLUME (CC/ML)	OIL WT	VOLUME (CC/ML)	OIL WT	VOLUME (CC/ML)	OIL WT	VOLUME (CC/ML)	OIL WT
REVELATION 409 DUAL AIR	115	5	15	15	6	15	15	15
REVELATION 409 AIR U-TURN	115	5	15	15	6	15	15	15
REVELATION 426 DUAL AIR	115	5	15	15	6	15	15	15
REVELATION 426 COIL U-TURN	115	5	15	15	-	-	30	15
REVELATION 426 AIR U-TURN	115	5	15	15	6	15	15	15
SID RACE	5	15	10	15	6	15	10	15
SID TEAM	-	-	10	15	6	15	10	15
SID WORLD CUP	-	-	10	15	6	15	10	15
TOTEM COIL	137	5	20	15	-	-	20	15
TOTEM SOLO AIR	137	5	20	15	6	15	20	15
TOTEM 2-STEP	137	5	20	15	135	2.5	20	15
TORA 289	145	5	15	15	-	-	20	15
TORA 289 COIL U-TURN	145	5	15	15	-	-	30	15
TORA 302	145	5	15	15	-	-	20	15
TORA 302 COIL U-TURN	145	5	15	15	-	-	30	15
TORA 318	145	5	15	15	-	-	20	15
TORA 318 COIL U-TURN	145	5	15	15	-	-	20	15
TORA 318 SOLO AIR	130	5	15	15	6	15	15	15

LOWER LEG REMOVAL



LOWER LEG REMOVAL

(ALL FORKS)

INTRODUCTION

Removing the lower legs of your fork is the first step in servicing your fork. It allows you access to your fork bushings, damper system and spring system. Once you have removed your fork lower legs, you'll be ready to move onto the next section.

LOWER LEG REMOVAL INSTRUCTIONS

NOTE: BOXXER ONLY - LOOSEN UPPER CROWN BOLTS WITH A 4MM HEX WRENCH AND REMOVE UPPER CROWN. SPRAY ISOPROPYL ALCOHOL ONTO UPPER TUBES AND UNDER FRAME BUMPERS. TWIST AND PULL UP TO REMOVE BUMPERS. FINALLY, USE A 4MM HEX WRENCH TO LOOSEN LOWER CROWN BOLTS AND REMOVE UPPERS FROM CROWN BY TWISTING AND SLIDING EACH UPPER DOWN AND OUT OF CROWN.

1. Remove the air chamber valve cover cap from the left fork leg top cap. If fork has a negative air chamber, remove the negative air chamber valve cover cap from the bottom of the left fork leg.
2. Depress schrader valve and release all air from the air chamber. If fork has a negative air chamber, start with the negative air chamber first, then proceed to the positive air chamber.
3. Gently pull external rebound adjuster knob and remove from the right shaft bolt.
4. Use a 5mm hex wrench to loosen both shaft bolts 3 to 4 turns. For Dual Air equipped forks, use a 10mm socket (or open end) wrench to loosen and unthread the Dual Air shaft nut just past the threaded shaft end.
5. Use a plastic mallet to gently tap each shaft bolt free from its press-fit to the lower leg and use your fingers to remove shaft bolts completely.
6. Remove the lower leg assembly from fork by firmly pulling it downward, holding onto both legs or the brake arch.
7. Use oil pan to drain excess oil from lower leg assembly.
8. Spray isopropyl alcohol onto and into the lower leg assembly. Wipe the lower legs clean, then wrap a clean rag around a dowel and clean the inside of each lower leg (not pictured).

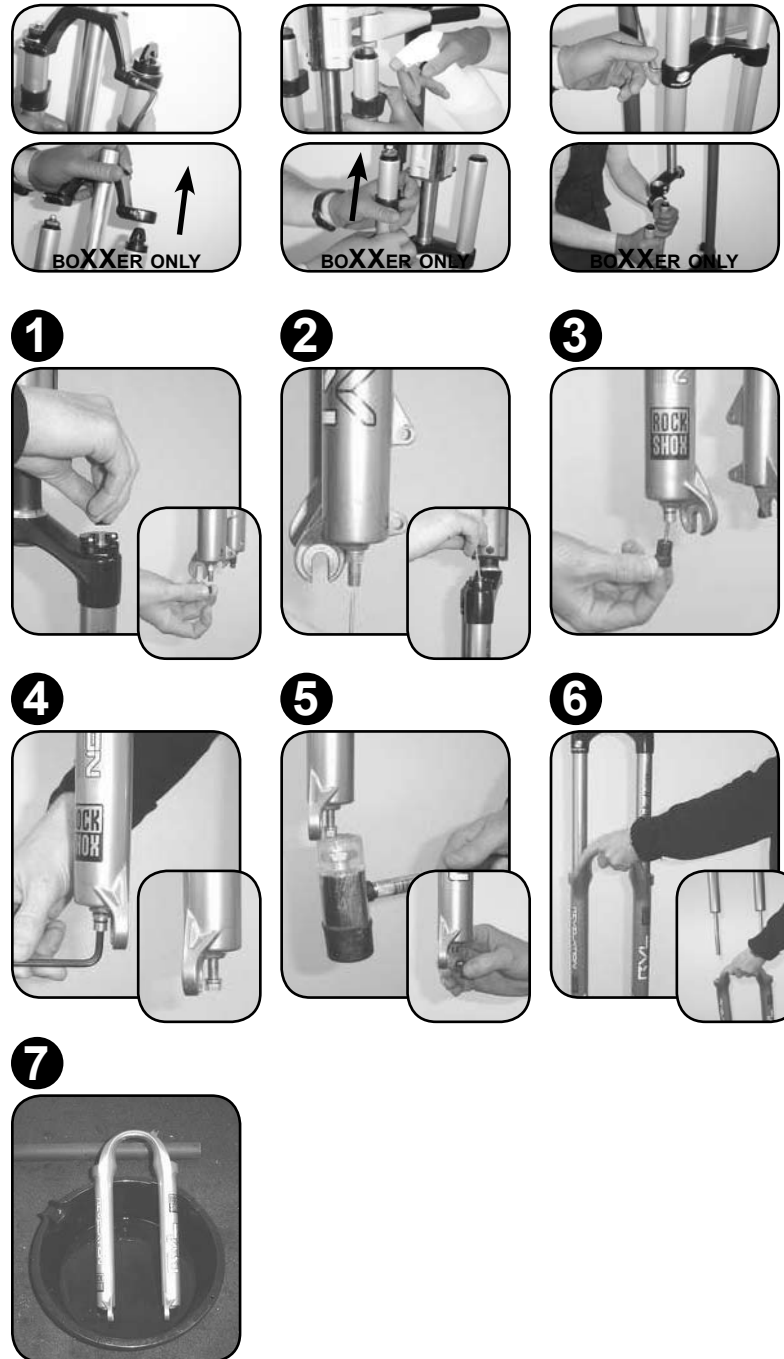

BUSHING SERVICE



BUSHING SERVICE (ALL FORKS)

INTRODUCTION

Suspension fork bushings are considered "wear and tear" parts and require regular maintenance, depending on the frequency of riding, riding terrain, rider body weight, and type of fork. The more you ride, the more frequently your bushings need to be replaced. The following chapter covers Dust & Oil Seal Removal, Bushing Removal, Bushing Installation, and Dust & Oil Seal Installation.

SYMPTOMS OF WORN BUSHINGS

Symptoms of worn bushings that need to be replaced include, a "knocking" sound from the fork when riding and/or the headset may feel loose when it isn't.

HOW TO CHECK FOR LOOSE BUSHINGS

1. Compress fork 5 times to circulate lower leg lube (not pictured).
2. Hold the front brake lever tight and rock the bike back and forth. If the fork feels like it's "knocking", or the headset feels loose, proceed to steps 2 and 3.
3. Check the fork: wrap your fingers around the dust seal and upper tube area. Rock the bike back and forth again. Listen and feel if there is any play between the upper tube and the dust seal. If so, the bushings are loose.
4. Check the headset: wrap your fingers around the headset upper cup or lower cup/race areas. Holding the brake, rock the bike back and forth and feel if the headset is loose. If so, tighten the headset and check again.

2

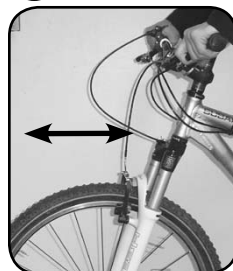

3



4

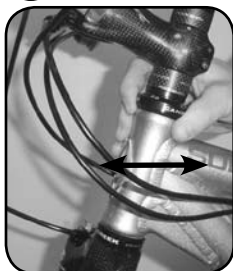

PARTS AND TOOL KITS NEEDED FOR BUSHING SERVICE

To obtain the parts and tool kits needed to service your fork bushings, visit your local SRAM dealer. If the parts and/or tool kits are not in stock, your dealer can place an order with their SRAM distributor. For a comprehensive list of RockShox spare parts and tool kits, please visit us on-line at www.rockshox.com or www.sram.com under the Spare Parts Catalog.

DUST & OIL SEAL REMOVAL (ALL FORKS)

1. Remove the dust seal using a medium to large flat-head screwdriver to carefully pry it from the lower leg.
NOTE: NOT ALL FORKS CONTAIN A FOAM RING. IF YOUR FORK DOES NOT HAVE A FOAM RING, PLEASE MOVE ONTO STEP 3.
2. Remove the oil foam ring with your fingers.
NOTE: NOT ALL FORKS CONTAIN AN INNER OIL SEAL. IF YOUR FORK DOES NOT HAVE AN INNER OIL SEAL, PLEASE MOVE ONTO THE NEXT SECTION, BUSHING REMOVAL.
3. Remove the inner oil seal, located just below the dust seal using a flat head screwdriver. To protect the lower leg paint, place a rag in between the lower leg and the screwdriver.
NOTE: THE NEW IMPROVED SAMURAI DUST SEAL ELIMINATES THE NEED TO REPLACE THE OIL SEAL.
NOTE: ALL DART FORKS AND TORA 289, 302 DO NOT HAVE SERVICEABLE BUSHINGS, PLEASE MOVE ONTO THE SECTION DUST & OIL SEAL INSTALLATION.

1



2



3



BUSHING REMOVAL

(ALL ARGYLE - BOXXER - DOMAIN - LYRIK - PIKE - REBA - RECON - REVELATION - SID - TOTEM & TORA 318)

1. Clamp bushing removal handle/puller tool into bench vice tightly.
2. Install the correct bushing removal plate onto handle end and secure with handle plate screw.
 - 28mm plate (SID)
 - 32mm plate (Argyle, BoXXer, Pike, Reba, Recon, Revelation, Tora)
 - 35mm plate (Domain, Lyrik)
 - 40mm plate (Totem)
3. Slide the removal plate past the upper bushing, pull lower leg away from puller tool, and hook the flat end of the plate secure under the bushing. The removal plate pivots when inserted. When the plate is secure under bushing, begin to remove.
4. To pull the upper bushing free from the lower leg, use a plastic mallet to firmly and squarely hit the top of the lower leg on the flat dust seal surface area until upper bushing pulls free.
5. To pull the lower bushing free from the lower leg, slide the removal plate past the lower bushing and hook the flat end of the plate secure under the bushing. Again, firmly and squarely hit the top of the lower leg on the flat dust seal surface area until the lower bushing pulls free. Longer lower bushings may require more force.
6. Return to Step 3 and repeat for the other fork leg.
7. Spray isopropyl alcohol inside lower legs. Wrap a clean rag around a dowel and clean the inside of the lower legs (not pictured).

1



2

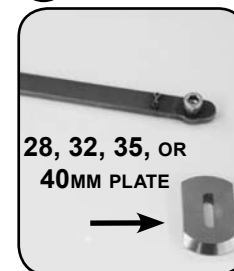

3

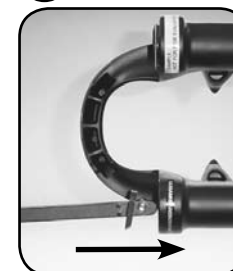

4



5

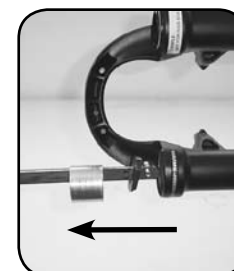

5

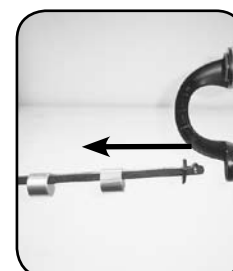

BUSHING INSTALLATION - 28MM UPPER TUBE DIAMETER (SID)

LOWER BUSHING INSTALLATION WITH BUSHING SIZE:
28MM x 20MM (SID)

1. Clamp 28mm bushing installation tool into bench mounted vice.
 2. Slide the lower bushing sleeve onto bushing installation post.
 3. Slide lower bushing onto top of lower bushing installation sleeve.
 4. Slide lower leg over installation post and rest on top of lower bushing.
 5. Insert the mallet drift tool into the lower leg shaft hole and hold in place with one hand. Using a plastic mallet, hit the mallet drift tool to press the bushing into the lower leg.
 6. Continue to hit the mallet drift tool until the lower leg dust seal ridge is level with the top of the installation post spacer.
 7. Remove lower leg from tool and inspect the fit of the lower bushing by sliding one upper tube into the lower leg. Hold lower leg 90° horizontally and release. Lower leg should swing 45° down and stop (not pictured).
- NOTE: IF LOWER LEG SWINGS TOO FREELY, REPEAT STEP 6. IF LOWER LEG FEELS TIGHT OR DOES NOT MOVE AT ALL, SLIDE LOWER LEG BACK ONTO BUSHING INSTALLATION POST AND ROCK SIDE TO SIDE TO LOOSEN FIT.**
8. Return to step 1 and repeat for other leg.

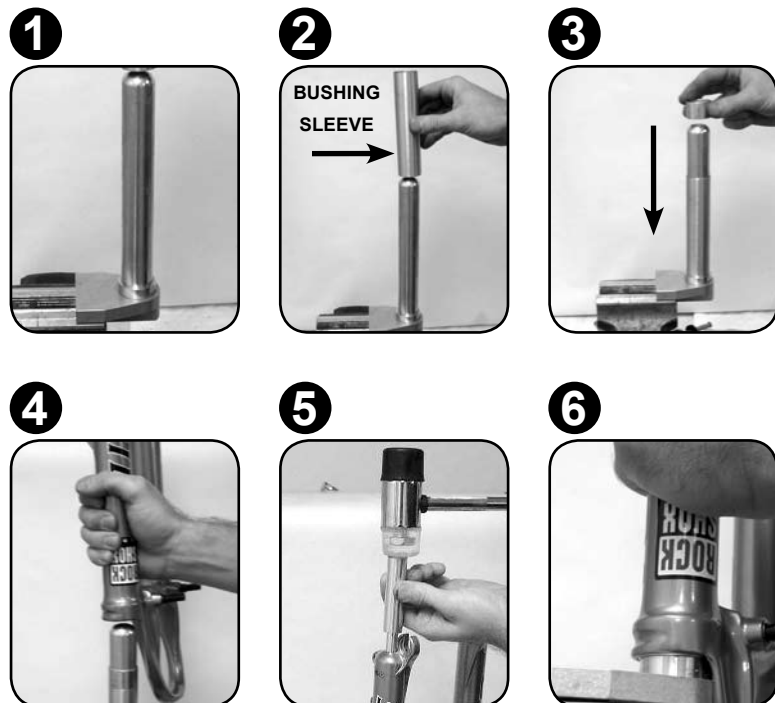

UPPER BUSHING INSTALLATION WITH BUSHING SIZE:
28MM x 10MM (SID)

9. Remove upper bushing installation sleeve from bushing installation post.
 10. Slide 10mm then 5mm upper bushing installation spacers onto bushing installation post.
 11. Slide upper bushing onto bushing installation post, on top of the 5mm spacer.
 12. Slide lower leg over installation post and rest on top of upper bushing.
 13. Insert mallet drift tool into the lower leg shaft hole and hold in place. Using a plastic mallet, hit the mallet drift tool to press the bushing into the lower leg.
 14. Continue to hit the mallet drift tool until the lower leg dust seal ridge is flush with the 5mm installation spacer.
 15. Remove lower leg from tool and inspect the fit of the upper bushing by sliding one upper tube into the lower leg. Hold lower leg 90° horizontally and release. Lower leg should swing 45° down and stop (not pictured).
- NOTE: DO NOT PRESS BUSHING BELOW BORE STEP.**
NOTE: IF LOWER LEG SWINGS TOO FREELY, REPEAT STEP 14. IF LOWER LEG FEELS TIGHT OR DOES NOT MOVE AT ALL, SLIDE LOWER LEG BACK ONTO BUSHING INSTALLATION POST AND ROCK SIDE TO SIDE TO LOOSEN FIT.
16. Return to Step 9 and repeat for other leg.

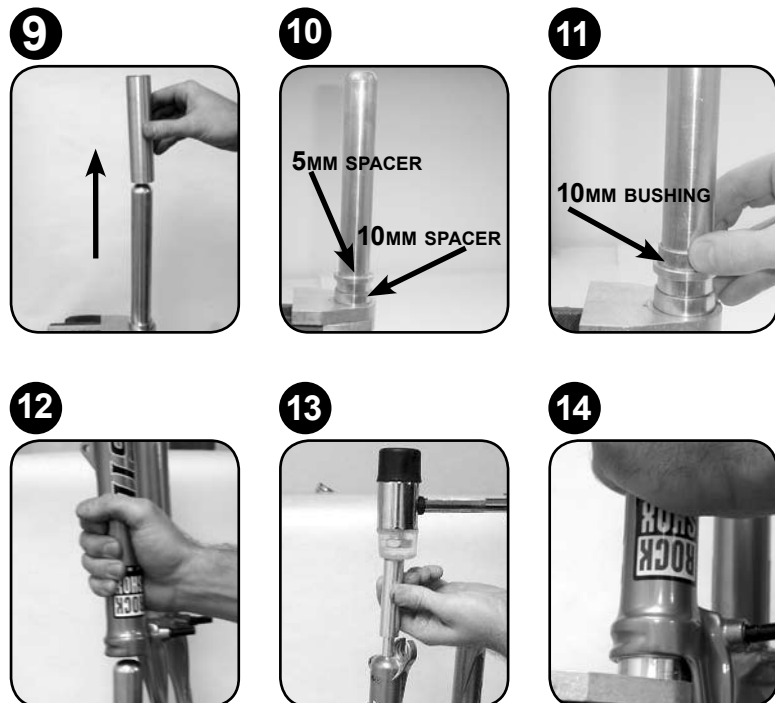

BUSHING INSTALLATION 32MM UPPER TUBE DIAMETER (ARGYLE - PIKE - REBA - RECON - REVELATION - TORA 318) 32MM UPPER TUBE DIAMETER (BOXXER)

LOWER BUSHING INSTALLATION WITH BUSHING SIZE:
32MM x 30MM - SLOTTED (ARGYLE, PIKE, REBA, RECON, REVELATION, TORA 318)
32MM x 76MM - NON-SLOTTED (BOXXER)

1. Clamp 32mm bushing installation tool into bench mounted vice.
 2. Slide lower bushing installation spacer onto bushing installation post.
- NOTE: RECON, REVELATION, AND TORA 318 USE TWO SPACERS, USE THE SHORT SPACER FOR THIS STEP.**
3. Slide the lower bushing sleeve onto bushing installation post.
 4. Recon, Revelation, Tora 318 Only: Slide the tall lower bushing spacer onto the bushing installation post.
 5. Slide lower bushing onto the top of the lower installation sleeve.
- NOTE: BOXXER LOWER BUSHING IS NOT SLOTTED.**
6. Slide lower leg over installation post and rest on top of lower bushing.
 7. Insert mallet drift tool into the lower leg shaft hole and hold in place. Using a plastic mallet, hit the mallet drift tool to press the bushing into the lower leg.
 8. Continue to hit the mallet drift tool, until the lower leg dust seal ridge is level with the top of the installation post spacer. You will feel it stop as the bushing is "set" in the lower leg.
 9. Remove lower leg from tool and inspect the fit of the lower bushing by sliding one upper tube into the lower leg. Hold lower leg 90° horizontally and release. Lower leg should swing 45° down and stop (not pictured).
- NOTE: IF LOWER LEG SWINGS TOO FREELY, REPEAT STEP 8. IF LOWER LEG FEELS TIGHT OR DOES NOT MOVE AT ALL, SLIDE LOWER LEG BACK ONTO BUSHING INSTALLATION POST AND ROCK SIDE TO SIDE TO LOOSEN FIT.**
10. Return to Step 1 and repeat for other leg.

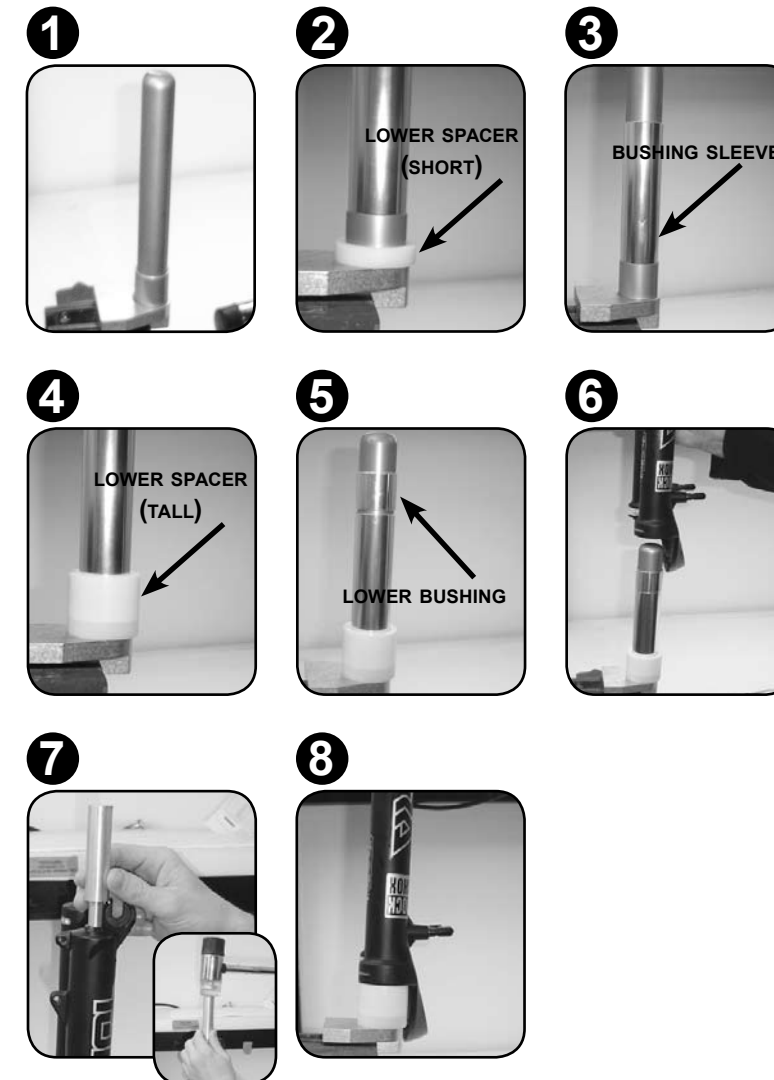

BUSHING INSTALLATION (CONT)
32MM UPPER TUBE DIAMETER (ARGYLE - PIKE - REBA - RECON - REVELATION - TORA 318)
32MM UPPER TUBE DIAMETER (BOXXER)

UPPER BUSHING INSTALLATION WITH BUSHING SIZE:
32MM x 30MM NON-SLOTTED (ARGYLE, PIKE, REBA, RECON, REVELATION, TORA 318)
32MM x 10MM - NON-SLOTTED (BOXXER)

11. Remove lower bushing sleeve (and tall lower bushing spacer for Recon, Revelation, and Tora 318). Leave only the lower bushing spacer on bushing installation tool.
12. Slide upper bushing onto bushing installation post.
13. Slide lower leg over installation post, and rest on top of the upper bushing.
14. Insert mallet drift tool into the lower leg shaft hole and hold in place. Using a plastic mallet, hit the mallet drift tool to press the upper bushing into lower leg.
15. Continue to hit the mallet drift tool until the lower leg rests flush on top of the install spacer. You will feel it stop as the bushing is "set" in the lower leg. The top of the bushing should be flush/level with oil seal step in the lower leg.
16. Remove lower leg from tool and inspect the fit of the lower bushing by sliding one upper tube into the lower leg. Hold lower leg 90° horizontally and release. Lower leg should swing 45° down and stop (not pictured).

NOTE: IF LOWER LEG SWINGS TOO FREELY, REPEAT STEP 15. IF LOWER LEG FEELS TIGHT OR DOES NOT MOVE AT ALL, SLIDE LOWER LEG BACK ONTO BUSHING INSTALLATION POST AND ROCK SIDE TO SIDE TO LOOSEN FIT.

17. Return to Step 11 and repeat for other leg.

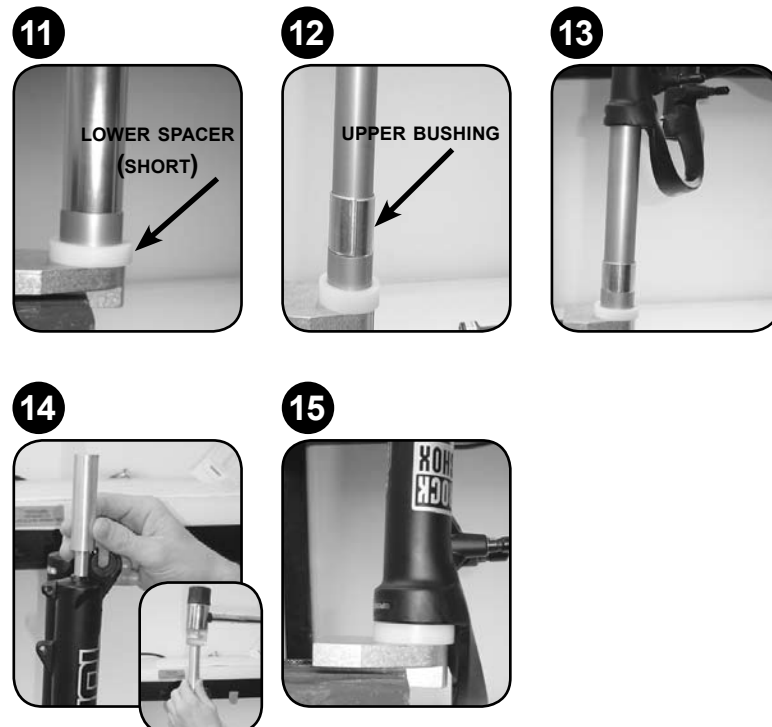

BUSHING INSTALLATION
35MM UPPER TUBE DIAMETER (DOMAIN - LYRIK)
40MM UPPER TUBE DIAMETER (TOTEM)

LOWER BUSHING INSTALLATION WITH BUSHING SIZE:
35MM x 30MM - SLOTTED (DOMAIN, LYRIK)
40MM x 30MM - SLOTTED (TOTEM)

1. Clamp 32mm bushing installation tool into bench mounted vice.
2. Slide bushing installation tool adapter over bushing installation post.
3. Slide lower bushing sleeve onto the adapter.
4. Slide lower bushing onto the adapter.
5. Slide lower leg over installation post and rest on top of lower bushing.
6. Insert mallet drift tool into the lower leg shaft hole and hold in place. Using a plastic mallet, hit the mallet drift tool to press the bushing into the lower leg.
7. Continue to hit the mallet drift tool, until the lower leg dust seal ridge is level with the top of the installation post spacer. You will feel the stopping point as the bushing is "set" into the lower leg.
8. Remove lower leg from tool and inspect the fit of the lower bushing by sliding one upper tube into the lower leg. Hold lower leg 90° horizontally and release. Lower leg should swing 45° down and stop (not pictured).

NOTE: IF LOWER LEG SWINGS TOO FREELY, REPEAT STEP 7. IF LOWER LEG FEELS TIGHT OR DOES NOT MOVE AT ALL, SLIDE LOWER LEG BACK ONTO BUSHING INSTALLATION POST AND ROCK SIDE TO SIDE TO LOOSEN FIT.

9. Return to Step 1 and repeat for other leg.

UPPER BUSHING INSTALLATION WITH BUSHING SIZE:
35MM x 30MM - NON SLOTTED (DOMAIN, LYRIK)
40MM x 30MM - NON SLOTTED (TOTEM)

10. Remove lower bushing sleeve from the adapter and slide upper bushing onto the adapter.
11. Slide lower leg over installation post, and rest on top of the upper bushing.
12. Insert mallet drift tool into the lower leg shaft hole and hold in place. Using a plastic mallet, hit the mallet drift tool to press the upper bushing into lower leg.
13. Continue to hit the mallet drift tool until the lower leg rests flush on top of the install spacer. You will feel it stop as the bushing is "set" in the lower leg. The top of the bushing should be flush/level with oil seal step in the lower leg.

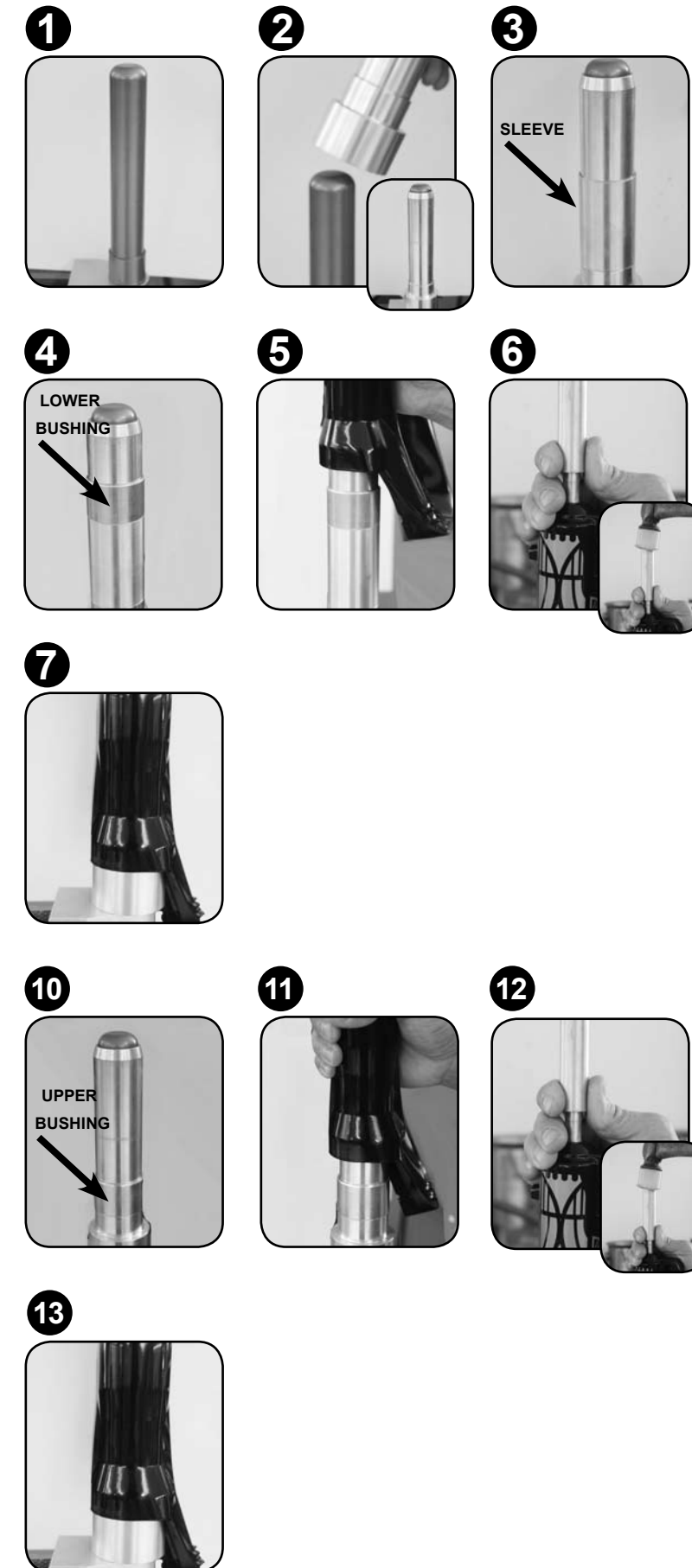

BUSHING INSTALLATION (CONT)
35MM UPPER TUBE DIAMETER (DOMAIN - LYRIK)
40MM UPPER TUBE DIAMETER (TOTEM)

UPPER BUSHING INSTALLATION WITH BUSHING SIZE:

35MM x 30MM - NON SLOTTED (DOMAIN, LYRIK)

40MM x 30MM - NON SLOTTED (TOTEM)

- Remove lower leg from tool and inspect the fit of the lower bushing by sliding one upper tube into the lower leg. Hold lower leg 90° horizontally and release. Lower leg should swing 45° down and stop (not pictured).

NOTE: IF LOWER LEG SWINGS TOO FREELY, REPEAT STEP 8. IF LOWER LEG FEELS TIGHT OR DOES NOT MOVE AT ALL, SLIDE LOWER LEG BACK ONTO BUSHING INSTALLATION POST AND ROCK SIDE TO SIDE TO LOOSEN FIT.

- Return to Step 10 and repeat for other leg.

DUST & SEAL INSTALLATION (SID)

FOAM RING AND DUST SEAL INSTALLATION

- Soak new foam rings in suspension oil.
- Slide dust seal installation tool over the 28mm bushing installation tool.
- Slide new dust seal over bushing installation tool and fit on top of dust seal installation tool.
- Slide oil-saturated foam ring over bushing installation tool and fit on top of dust seal. Seat the foam ring inside the under cavity of the dust seal. Wipe excess oil off the dust seal with a clean rag.
- Slide lower leg onto bushing installation tool, on top of new dust seal. Insert mallet drift tool into the lower leg shaft hole and hold in place. Using a plastic mallet, hit the mallet drift tool until dust seal seats inside lower leg, flush with the top of the lower leg dust seal step.
- Dust seal should be press-fit snug into the lower leg.
- Return to Step 1 and repeat for other leg.

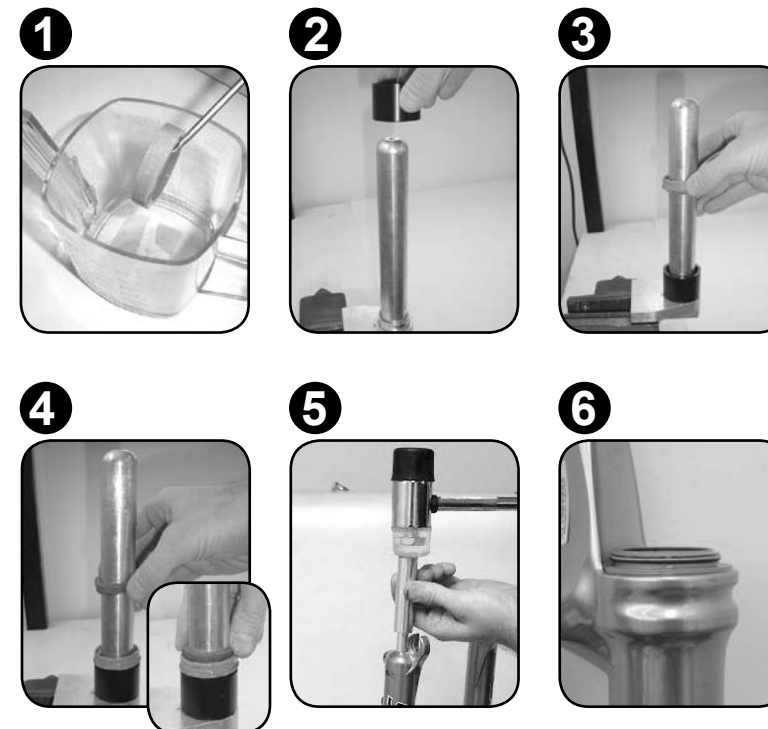

DUST & OIL SEAL INSTALLATION (RECON - REVELATION - TORA 318)

FOAM RING INSTALLATION

- Soak new foam rings in suspension oil.
- Insert new oil-saturated foam ring into lower leg.

DUST SEAL INSTALLATION

- Insert new dust seal into the wide end of the dust seal installation tool.
- Insert dust seal into lower leg and press straight down and evenly to seat into lower leg.
- Dust seal should be press-fit snug and flush into lower leg.

NOTE: CHECK FOAM RING UNDER DUST SEAL. FOAM RING SHOULD NOT PROTRUDE FROM DUST SEAL. IF SO, ADJUST FOAM RING INSIDE LOWER LEG, FLUSH ON ALL SIDES.

- Return to Step 1 and repeat for other leg.

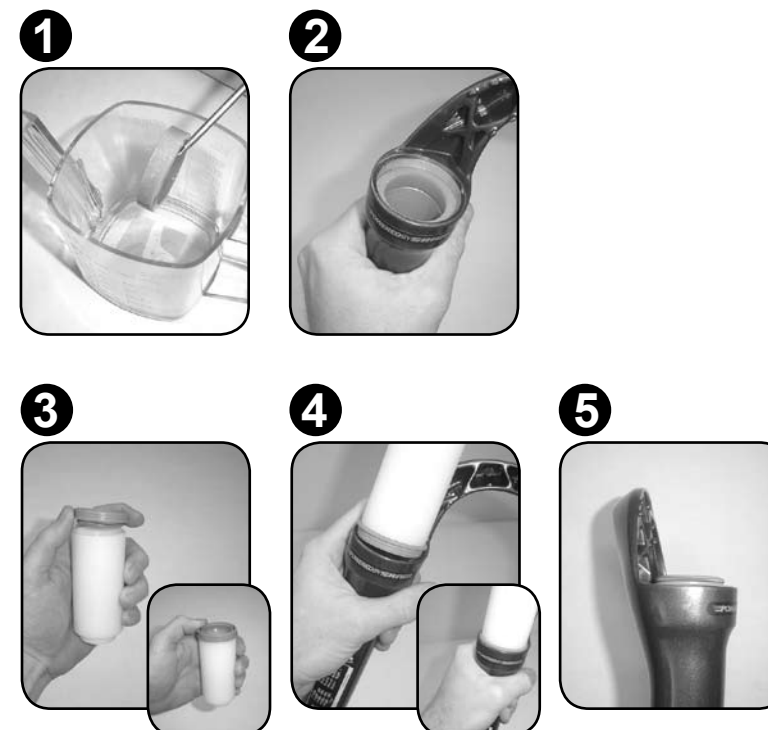

DUST & OIL SEAL INSTALLATION (ARGYLE - BOXXER - DOMAIN - LYRIK - PIKE - REBA - TOTEM)

OIL SEAL INSTALLATION

1. Apply grease or suspension oil to the inside of the lower leg oil seal counter-bore.
2. Insert the new oil seal onto the stepped end of the oil/dust seal installation tool.
3. Using the oil/dust seal installation tool, insert the oil seal down and into the oil step in the lower leg. Apply pressure on all sides of the oil seal to seat it into place.

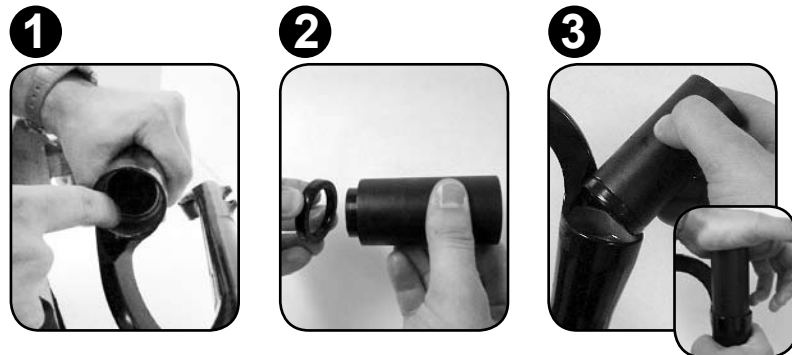

FOAM RING INSTALLATION

NOTE: FOR DOMAIN, LYRIK, AND TOTEM, PLEASE MOVE ONTO DUST SEAL INSTALLATION, STEP 6.

4. Soak new foam rings in suspension oil.
5. Insert new oil-saturated foam ring into lower leg on top of oil seal.

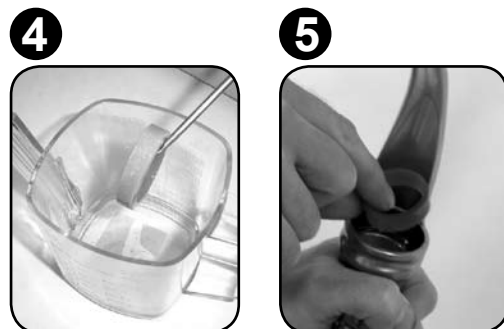

DUST SEAL INSTALLATION

6. Insert new dust seal into the wide end of the oil/dust seal installation tool.
7. Using the oil/dust installation tool, insert dust seal into lower leg. Apply pressure on all sides of the dust seal to seat it into place.
8. Dust seal should be press-fit snug and flush into lower leg.

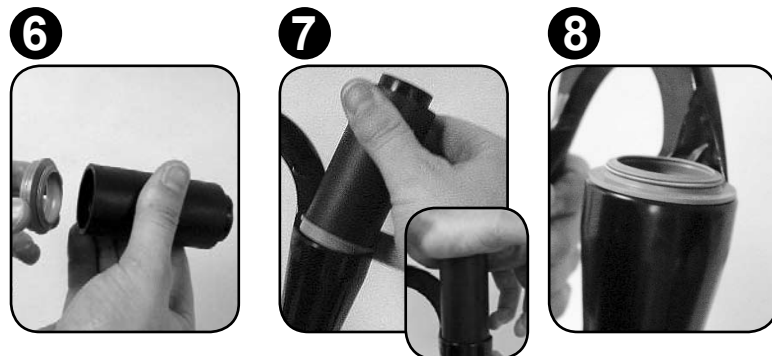

NOTE: CHECK FOAM RING UNDER DUST SEAL. FOAM RING SHOULD NOT PROTRUDE FROM DUST SEAL. IF SO, ADJUST FOAM RING INSIDE LOWER LEG, FLUSH ON ALL SIDES.

9. Return to Step 1 and repeat for other leg.

DAMPER SERVICE

COMPLETING BUSHING SERVICE (ALL FORKS)

Complete the bushing service of your fork by detailing the lower legs. Spray isopropyl alcohol on entire lower leg assembly and wipe with a clean rag. Check the decals on your fork and replace if necessary.

THIS CONCLUDES THE BUSHING SERVICE FOR YOUR FORK. YOU DID A GREAT JOB! YOU ARE NOW READY TO MOVE ONTO THE NEXT SECTION, DAMPER SERVICE. ENJOY!



REBOUND & TURNKEY DAMPER SERVICE

(ARGYLE 302 - DART 2, 2 WITH TURNKEY, 3 - DOMAIN 302 - RECON 335 - TORA 289, 302)

INTRODUCTION

At this point you should already have the lowers removed from your fork. If not, you will need to return to the Lower Leg Removal section of this manual and follow the instructions for removing your fork lowers.

DAMPER REMOVAL/SERVICE INSTRUCTIONS

NOTE: FOR DART 2, AND TORA 289 PLEASE SKIP STEP 1 AND MOVE ONTO STEP 2.

- Remove external snap ring from compression adjuster knob using external snap ring pliers and remove compression adjuster knob and o-ring.
OR
If fork is equipped with a remote compression lockout feature, remove external snap ring from compression adjuster spool using external snap ring pliers and remove compression adjuster spool and white top cap shield.
- Unthread compression damper top cap with a 24mm socket wrench.
NOTE: FOR ARGYLE 302, DART 2, DOMAIN 302, AND TORA 289 PLEASE MOVE ONTO STEP 5.
- Remove compression damper by pulling up and gently rocking side to side. If fork is equipped with a remote lockout feature, be sure to remove the remote compression damper cable-stop clamp; which is located under the compression damper top cap. Once removed, clean upper tube threads with a rag.
- Replace compression damper top cap o-ring by gently pinching o-ring to remove. Apply a few drops of suspension oil to new o-ring and re-install.
- Remove fork from bicycle stand and pour remaining oil into pan.
NOTE: FOR DART 2, THIS COMPLETES THE REMOVAL PROCEDURES, PLEASE MOVE ONTO STEP 10.
- Turn fork upside down and push rebound damper shaft through shaft guide. Use a long dowel rod to help push damper piston past upper tube threads and remove from upper tube.
- Remove rebound damper o-ring and damper inner seal-head o-ring (located in the bottom of the upper tube). Apply fresh grease to new o-rings and re-install.
IMPORTANT: IF USING A PICK TO REMOVE INNER SEAL HEAD O-RING, DO NOT SCRATCH O-RING GLAND. SCRATCHES MAY CAUSE OIL TO LEAK.

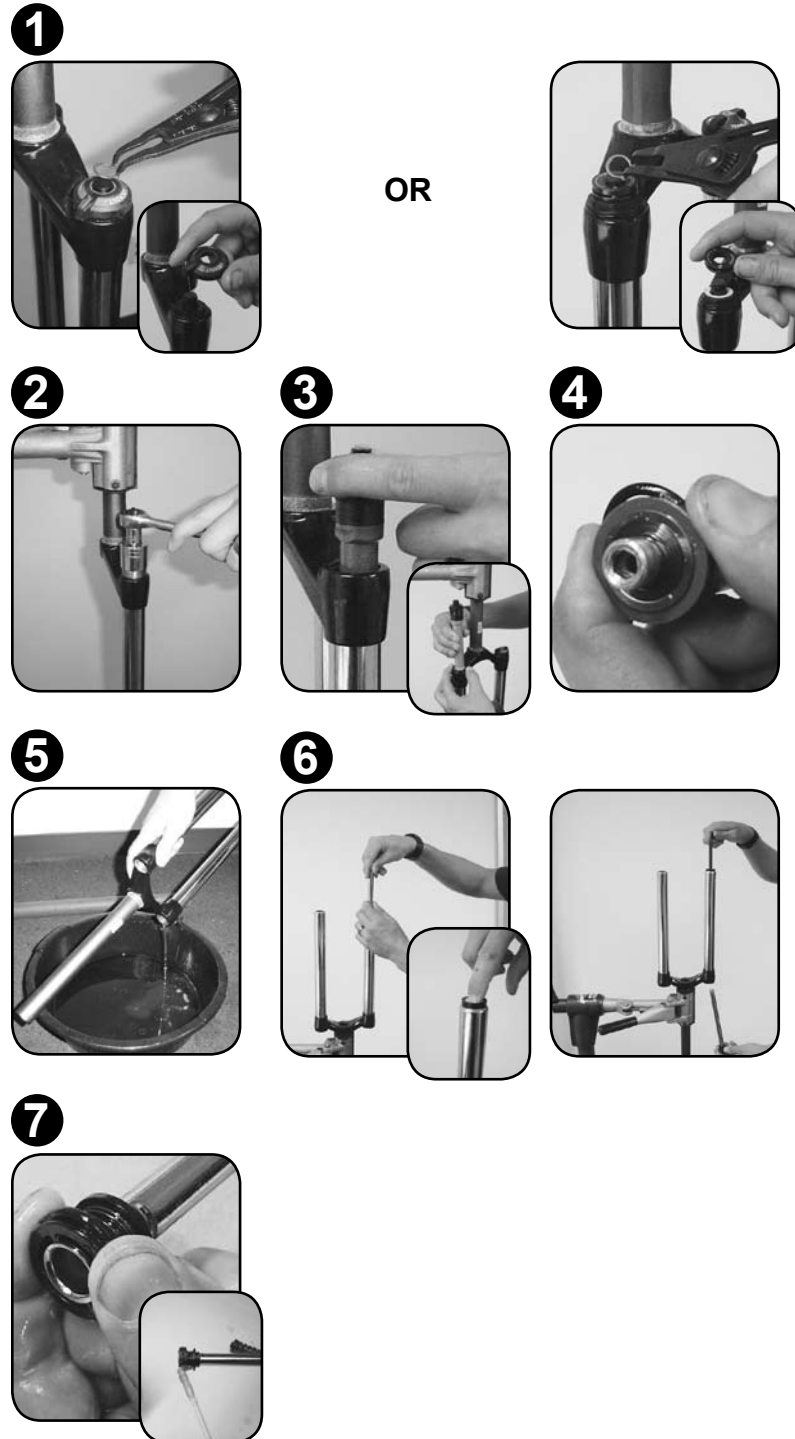

OPTIONAL - COMPRESSION DAMPER UPGRADE: NON-REMOTE TO REMOTE ADJUST

Upgrading from a non-remote compression adjust fork to a remote compression adjust (from a crown mounted adjuster knob to a remote PopLoc or PushLoc lever adjuster), requires replacing the non-remote compression damper with a remote compression damper and cable-stop clamp. The remote return spring is integrated into the compression damper and is required for use with the PopLoc and PushLoc remote lever assembly.

DAMPER INSTALLATION INSTRUCTIONS

- Clamp fork back into bicycle stand and apply a light film of grease to upper tube threads. Insert rebound damper back into right side of upper tube, shaft first and press piston into upper tube past tube threads.
- Push rebound damper into upper tube using a long dowel rod. Guide rebound damper shaft through damper seal head at the bottom of the upper tube and pull shaft through by hand into the fully extended position.
- Measure and pour 5wt suspension oil into the upper tube using the following volumes:

FORK	OIL VOLUME (±5cc/ML)
ARGYLE 302	130cc/ML
DART 2	150cc/ML
DART 2 (WITH TURNKEY)	93cc/ML
DART 3	93cc/ML
DOMAIN 302	200cc/ML
TORA 289	145cc/ML
TORA 302	145cc/ML

NOTE: FOR DART 2 AND TORA 289 PLEASE MOVE ONTO STEP 12.

IMPORTANT: OIL VOLUME IS CRITICAL. TOO MUCH OIL REDUCES AVAILABLE TRAVEL, WHICH CAN LEAD TO FORK DAMAGE FROM COMPRESSION BOTTOM OUT. TOO LITTLE OIL DECREASES DAMPING PERFORMANCE.

- Remote Only: Position cable-stop clamp in the 10 o'clock position around the upper tube hole on the crown prior to inserting compression damper. Grease upper tube threads liberally then insert compression damper into upper tube. Press down and twist to work damper into upper tube. Be careful not to damage o-ring seals on upper tube threads.
- Press top cap down into upper tube threads and hand tighten. Using a 24mm socket wrench, tighten to 60 in/lbs.
NOTE: FOR DART 2 AND TORA 289, THIS COMPLETES THE INSTALLATION INSTRUCTIONS. YOU ARE READY TO MOVE ONTO THE NEXT SECTION IN THIS MANUAL, SPRING SERVICE.

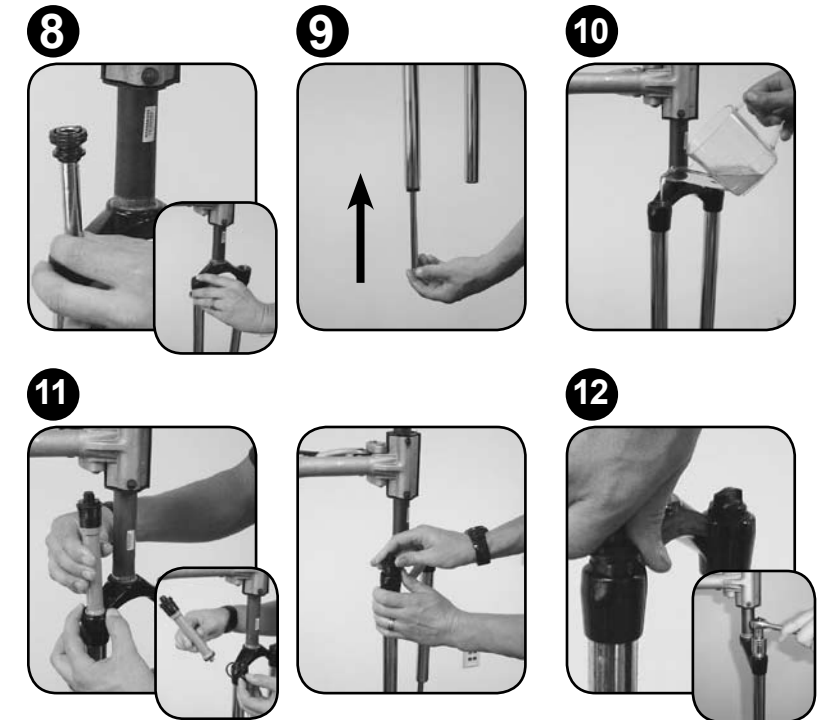

DAMPER INSTALLATION INSTRUCTIONS (CONT)

NOTE: TURN COMPRESSION ADJUSTER HEX COUNTERCLOCKWISE TO THE OPEN POSITION.

13. Place compression adjuster knob onto compression damper top cap with the knob dial set in the 3 o'clock position. Using external snap ring pliers, secure the compression adjuster knob with a new snap ring.

13



OR



OR

If fork is equipped with a remote compression lockout feature, place remote spool onto compression damper top cap with the cable set screw in the 3 o'clock position.

Using external snap ring pliers, secure the remote spool with a new snap ring.

THIS CONCLUDES THE DAMPER SERVICE FOR YOUR FORK. YOU DID A GREAT JOB! YOU ARE NOW READY TO MOVE ONTO THE NEXT SECTION, SPRING SERVICE. ENJOY!

MOTION CONTROL DAMPER SERVICE

(ARGYLE 318, 409- DOMAIN 318 - TORA 318)

INTRODUCTION

At this point you should already have the lowers removed from your fork. If not, you will need to return to the Lower Leg Removal section of this manual and follow the instructions for removing your fork lowers.

DAMPER REMOVAL/SERVICE INSTRUCTIONS

NOTE: FOR ARGYLE 318 AND 409, IT IS NOT NECESSARY TO REMOVE THE MOTION CONTROL KNOB, PLEASE SKIP STEP ONE AND MOVE ONTO STEP 2.

1. Remove external snap ring from compression adjuster knob using external snap ring pliers and remove compression adjuster knob and o-ring seal.

OR

If fork is equipped with a remote compression lockout feature, remove external snap ring from compression adjuster spool using external snap ring pliers and remove compression adjuster spool and white top cap seal.

2. Unthread compression damper top cap with a 24mm socket wrench.
3. Remove compression damper from upper tube/crown by pulling up and gently twisting side to side. If fork is equipped, be sure to remove the remote compression damper cable-stop clamp; which is located under the compression damper top cap. Once removed, clean upper tube threads with a rag.
4. With a sharp pick, remove the compression damper top cap o-ring (located at the top of the damper) and the compression damper seal (located at the bottom of the damper). Apply a few drops of suspension oil to the new o-ring and seal and install.
5. Remove fork from bicycle stand and pour remaining oil into pan.
6. Turn fork upside down. Push rebound damper shaft into upper tube/seal head and remove rebound damper from upper tube.
7. Remove rebound damper glide ring and inner seal head o-ring. Apply fresh grease to new o-rings and re-install.

IMPORTANT: IF USING A PICK TO REMOVE INNER SEAL HEAD O-RING, DO NOT SCRATCH O-RING GLAND. SCRATCHES MAY CAUSE OIL TO LEAK.

1



OR



2



3



4

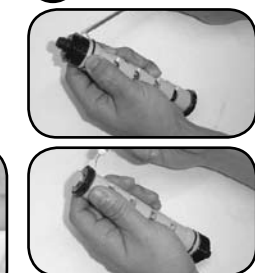

5



6

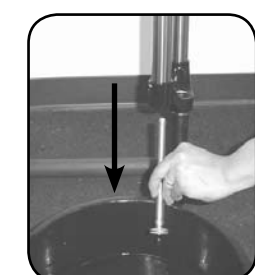
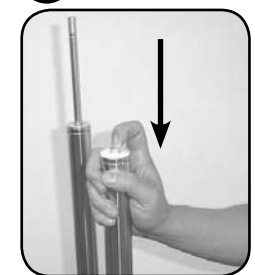

7



OPTIONAL - COMPRESSION DAMPER UPGRADE: NON-REMOTE TO REMOTE ADJUST (TORA 318 ONLY)

Upgrading from a non-remote compression adjust fork to a remote compression adjust (from a crown mounted adjuster knob to a remote PopLoc or PushLoc lever adjuster), requires replacing the non-remote compression damper with a remote compression damper and cable-stop clamp. The remote return spring is designed into the compression damper and is required for use with the PopLoc and PushLoc remote lever assembly.

DAMPER INSTALLATION INSTRUCTIONS

8. Clamp fork back into bicycle stand. Insert rebound damper back into right side of upper tube, shaft first. Guide rebound damper through damper seal head at bottom of upper tube and pull through.
9. Thread shaft bolt into rebound damper shaft end and pull rebound damper shaft down through seal head into fully extended position.
10. Measure and pour 5wt suspension oil into the upper tube, through the crown using the following volumes:

FORK	OIL VOLUME (±5cc/ML)
ARGYLE 318	130cc/ML
ARGYLE 409	130 cc/ML
DOMAIN 318	200 cc/ML
TORA 318	145 cc/ML

IMPORTANT: OIL VOLUME IS CRITICAL. TOO MUCH OIL REDUCES AVAILABLE TRAVEL, WHICH CAN LEAD TO FORK DAMAGE FROM COMPRESSION BOTTOM OUT. TOO LITTLE OIL DECREASES DAMPING PERFORMANCE.

11. Remote Only: Slide compression damper through cable-stop clamp prior to insertion. Position the cable-stop clamp in the 10 o'clock position on the crown. Grease upper tube threads liberally, then insert compression damper into upper tube. Press down and twist to work damper into upper tube.
12. As soon as the damper seal passes through the upper tube threads, pull the damper up slightly, then push back down. The compression damper should slide up and down easily, indicating the seal in the proper position, and not folded over. Repeat procedure until the compression damper slides up and down easily. Then press the compression damper down until the upper o-ring contacts the upper tube threads.

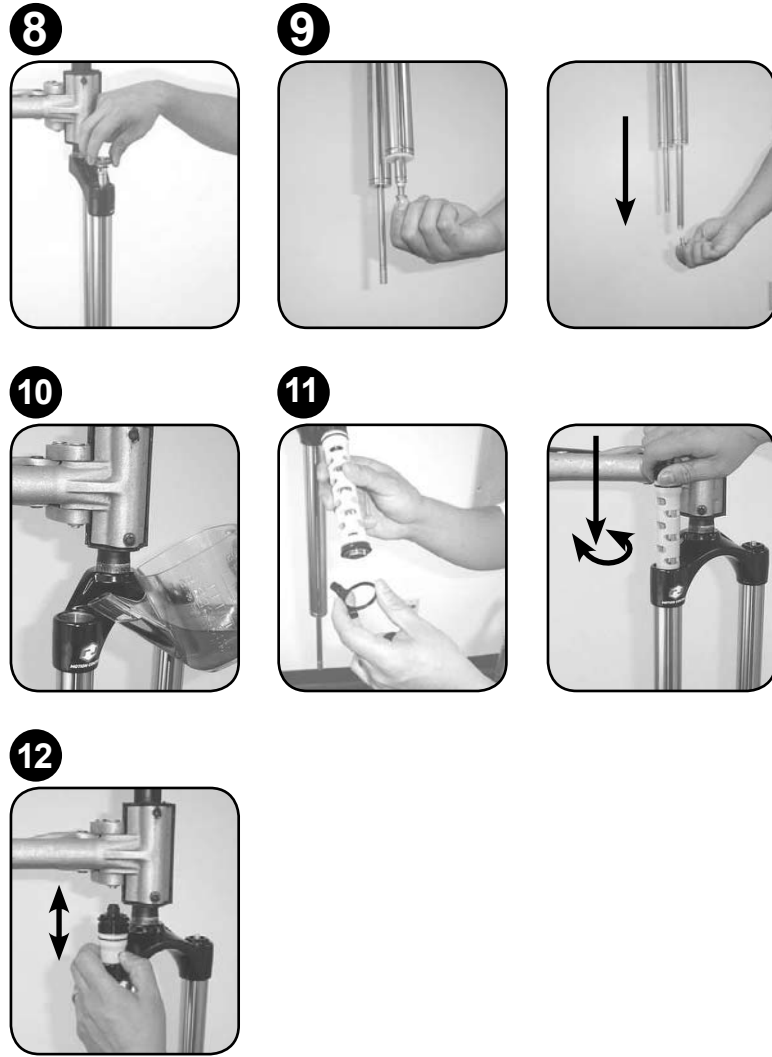

DAMPER INSTALLATION INSTRUCTIONS (CONT)

13. Turn the damper clockwise and thread into the upper tube. Be careful not to damage the upper damper o-ring. Continue to thread top cap down into upper tube threads and hand tighten. Using a 24mm socket wrench, tighten to 60 in/lbs.
NOTE: FOR ARGYLE 318 AND 409 THIS COMPLETES THE INSTALLATION PROCESS.
NOTE: TURN COMPRESSION ADJUSTER HEX COUNTERCLOCKWISE TO THE OPEN POSITION.
14. Place compression adjuster knob onto compression damper top cap with the knob dial set in the 3 o'clock position. Using external snap ring pliers, secure the compression adjuster knob with a new snap ring.
OR
 If fork is equipped with a remote compression lockout feature, place remote spool onto compression damper top cap with the cable set screw in the 3 o'clock position. Using external snap ring pliers, secure the remote spool with a new snap ring.

THIS CONCLUDES THE DAMPER SERVICE FOR YOUR FORK. YOU DID A GREAT JOB! YOU ARE NOW READY TO MOVE ONTO THE NEXT SECTION, SPRING SERVICE. ENJOY!

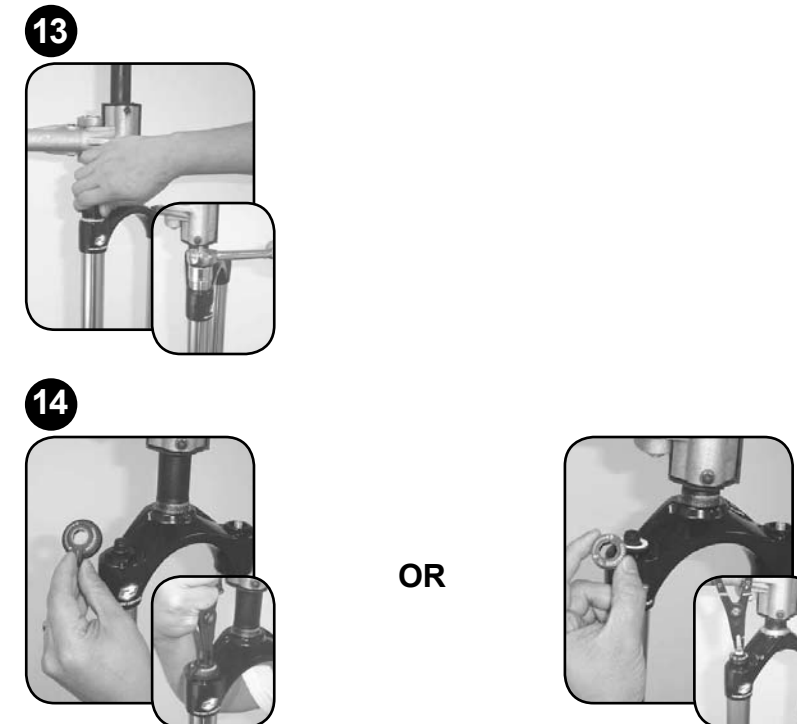

MOTION CONTROL DAMPER SERVICE

(BOXXER RACE, TEAM, WC - PIKE 409, 426 - REBA SL, RACE, TEAM, WC - RECON 351 - REVELATION 409, 426)

INTRODUCTION

At this point you should already have the lowers removed from your fork. If not, you will need to return to the Lower Leg Removal section of this manual and follow the instructions for removing your fork lowers.

DAMPER REMOVAL/SERVICE INSTRUCTIONS

NOTE: BoXXer ONLY, IT IS NOT NECESSARY TO REMOVE THE MOTION CONTROL ADJUSTER KNOB. PLEASE SKIP STEP 1 AND MOVE ONTO STEP 2.

1. Remove external snap ring from compression adjuster knob using external snap ring pliers and remove compression adjuster knob and o-ring seal.

OR

If fork is equipped with a remote compression lockout feature, remove external snap ring from compression adjuster spool using external snap ring pliers and remove compression adjuster spool and white top cap seal.

2. Unthread compression damper top cap with a 24mm socket wrench.
3. Remove compression damper from upper tube/crown by pulling up and twisting side to side. Once removed, clean upper tube threads with a rag.
4. With a sharp pick, remove compression damper o-rings (located at the top and bottom of the damper). Apply a few drops of suspension oil to new o-rings and re-install.
5. Remove fork from bicycle stand and pour remaining oil into pan.
6. Remove rebound damper seal head retaining ring (located inside the bottom of the right upper tube), using external snap ring pliers. Pull down and remove the rebound damper and seal head assembly from the upper tube.
7. Slide seal head off damper shaft and remove inner and outer seal head o-rings. Apply a few drops of suspension oil to new o-rings and re-install.
8. Spray isopropyl alcohol on rebound damper shaft, and clean with a rag (not pictured).
9. If damaged, replace rebound damper piston glide ring. Position upper tube base ring on top of seal head step and slide rebound seal head assembly onto rebound damper shaft.
10. Spray isopropyl alcohol into the upper tube. Wrap a clean rag around a dowel and clean the inside of the upper tube (not pictured).

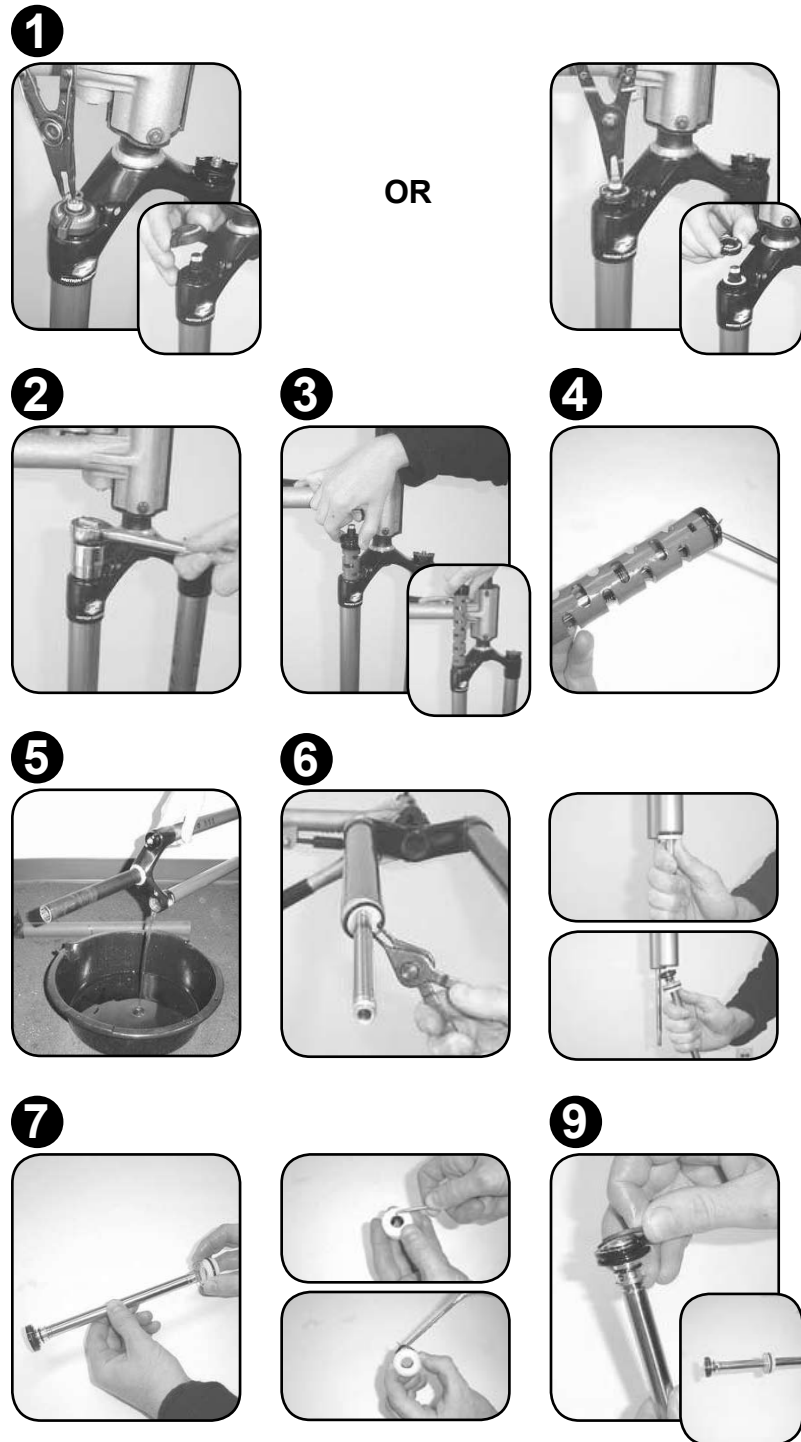

DAMPER INSTALLATION INSTRUCTIONS

11. Insert rebound damper piston into the bottom of the upper tube at an angle, with the open-ended side of the glide ring face outward. Continue to angle and rotate until glide ring is in the upper tube. Position the upper tube base ring seal and seal head into the upper tube.
12. Position the upper tube base ring seal and seal head into the upper tube and press into the upper tube with your thumb.
13. Use internal snap ring pliers to secure seal head into upper tube with retaining ring.
IMPORTANT: MAKE SURE THE RETAINING RING IS SECURELY FASTENED IN THE UPPER TUBE GROOVE. YOU CAN CHECK THIS BY USING THE SNAP RING PLIERS TO ROTATE THE RETAINING RING IN THE SHAFT ONE COMPLETE REVOLUTION.
14. Pull rebound damper shaft down, into the fully extended position. Measure and pour 5wt suspension oil into the upper tube, through the crown, using the following volumes:

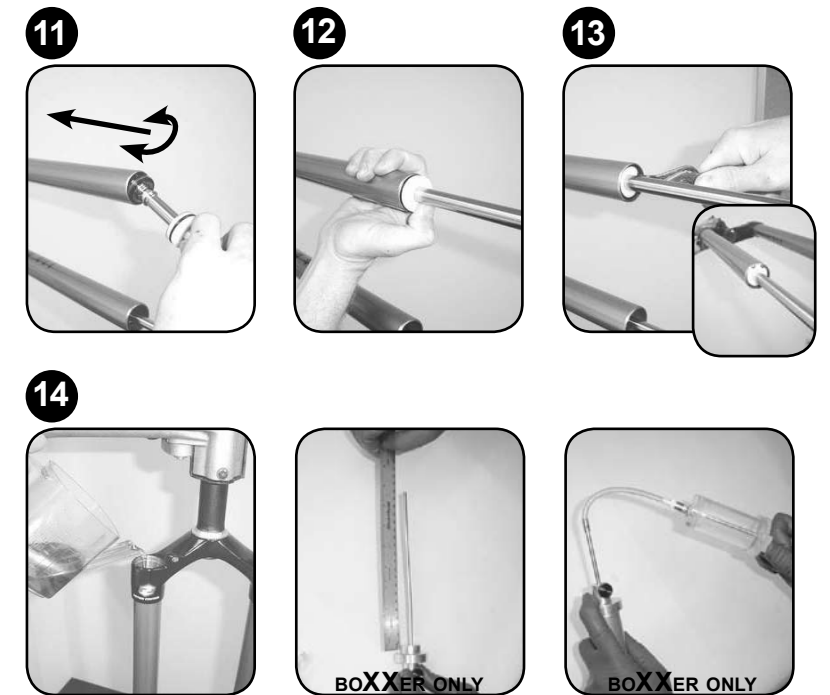

FORK	OIL VOLUME (±5cc/ML)
BOXXER RACE, TEAM, WC	150cc/ML*
PIKE 409, 426	120cc/ML
REBA SL, RACE, TEAM, WC	110cc/ML
RECON 351	118cc/ML
REVELATION 409, 426	114cc/ML

***BOXXER ONLY OPTIONAL PROCEDURE: YOU CAN USE A SUSPENSION OIL HEIGHT TOOL TO MEASURE OIL VOLUME. MEASURE AND SET SYRINGE NEEDLE STOP TO 205MM. POUR 5WT OIL INTO UPPER TUBE. INSERT SYRINGE NEEDLE INTO THE UPPER TUBE, RESTING THE STOP FLAT ON UPPER TUBE. PULL OUT ANY EXCESS OIL WITH SYRINGE PLUNGER. REMOVE OIL HEIGHT TOOL FROM UPPER TUBE. IMPORTANT: OIL VOLUME IS CRITICAL. TOO MUCH OIL REDUCES AVAILABLE TRAVEL, WHICH CAN LEAD TO FORK DAMAGE FROM COMPRESSION BOTTOM OUT. TOO LITTLE OIL DECREASES DAMPING PERFORMANCE.**

DAMPER INSTALLATION INSTRUCTIONS (CONT)

15. Insert compression damper into upper tube. Press down and twist to work damper into upper tube.
16. Turn the damper clockwise and thread into the upper tube. Be careful not to damage the upper damper o-ring. Continue to thread top cap down into upper tube threads and hand tighten. Using a 24mm socket wrench, tighten to 60 in/lbs.

15

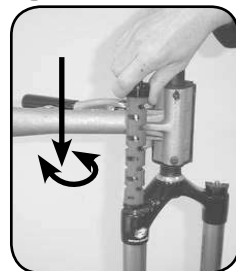

16



NOTE: FOR BOXXER, THIS COMPLETES THE INSTALLATION PROCEDURES.

NOTE: TURN COMPRESSION ADJUSTER HEX COUNTERCLOCKWISE TO THE OPEN POSITION.

17. Place compression adjuster knob onto compression damper top cap with the knob dial set in the 3 o'clock position. Using external snap ring pliers, secure the compression adjuster knob with a new snap ring.

17



OR



OR

If fork is equipped with a remote compression lockout feature, place remote spool onto compression damper top cap with the cable set screw in the 3 o'clock position. Using external snap ring pliers, secure the remote spool with a new snap ring.

THIS CONCLUDES THE DAMPER SERVICE FOR YOUR FORK. YOU DID A GREAT JOB! YOU ARE NOW READY TO MOVE ONTO THE NEXT SECTION, SPRING SERVICE. ENJOY!

MOTION CONTROL DAMPER SERVICE (SID TEAM, WORLD CUP)

INTRODUCTION

At this point you should already have the lowers removed from your fork. If not, you will need to return to the Lower Leg Removal section of this manual and follow the instructions for removing your fork lowers.

DAMPER REMOVAL/SERVICE INSTRUCTIONS

1. Remove remote cable stop clamp using a 2.5mm hex wrench.
2. Remove Floodgate adjuster knob using a 1.5mm hex wrench.
3. Remove external snap ring from compression adjuster spool using external snap ring pliers and remove compression adjuster spool and return spring.
4. Unthread compression damper top cap with a 24mm socket wrench.
5. Remove compression damper, damper tube and rebound damper assembly from upper tube/crown by pulling up and twisting side to side. Clean upper tube threads with a rag.

1



2



3



NOTE: LEAVE THE THREADED BASE RETAINER INSIDE THE BOTTOM OF THE UPPER TUBE.

6. Pull the rebound damper/seal head assembly from the bottom of the damping tube. Be sure to wrap a rag around the damper tube, as oil will drain from the assembly. Pour remaining oil from damper tube into oil pan.
7. Remove compression damper from damper tube by pulling up gently. Allow any excess oil to drain into oil pan.
8. Spray compression damper assembly and damper tube (inside and out) with isopropyl alcohol. Wipe grease and oil from damper assembly and outside of damper tube. Wrap a clean rag around a dowel and clean the inside of the damper tube (not pictured).
9. Slide seal head off rebound damper shaft and remove inner and outer seal head o-rings. Apply a few drops of suspension oil to new o-rings and install.
10. Spray rebound damper shaft with isopropyl alcohol, and clean with a rag (not pictured).
11. Inspect rebound damper piston glide ring and damper shaft. Replace either, if damaged. Slide rebound damper seal head back onto rebound damper shaft.
12. Insert a 2.5mm hex wrench (or rebound adjuster knob) into rebound damper adjuster at the bottom of the shaft, and turn counterclockwise to open the rebound damper valve. This allows oil to flow into the damper valve when re-filling damper tube with oil.

4



5



6



7



8



9



11

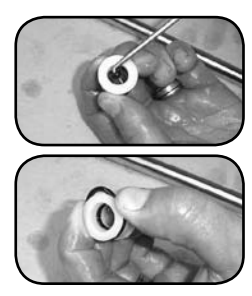

12



12

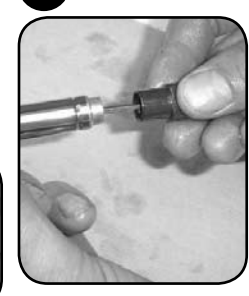

DAMPER REMOVAL/SERVICE INSTRUCTIONS (CONT)

13. Lubricate rebound damper and seal head by submerging in a container of suspension oil.
14. Remove compression damper o-rings (lower, internal floating piston - IFP, and primary). Apply a few drops of suspension oil to new o-rings and install.

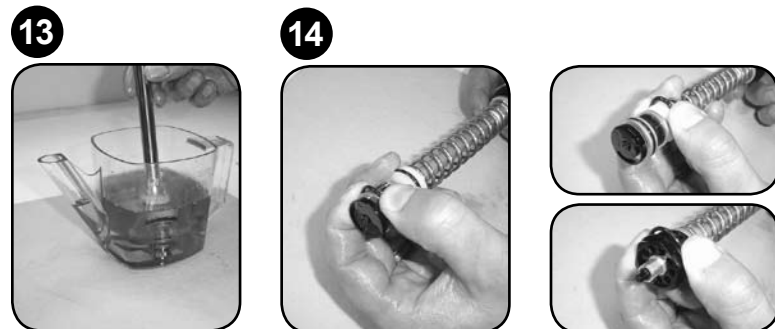

DAMPER INSTALLATION INSTRUCTIONS

15. Place gold Floodgate adjuster knob back onto the compression damper and tighten with a 1.5mm hex wrench.
16. Turn the Floodgate and compression spool adjuster hex counterclockwise until it stops. This is the full open position.

NOTE: THE FLOODGATE ADJUSTMENT AFFECTS THE BLOW-OFF THRESHOLD WHILE THE COMPRESSION DAMPER IS IN THE 'LOCK-OUT' POSITION. THE MORE OPEN THE FLOODGATE, THE LOWER THE AMOUNT OF FORCE THAT IS REQUIRED TO COMPRESS THE FORK IN THE LOCK-OUT POSITION.

17. Apply suspension oil to both the main piston and IFP o-rings of the compression damper.
18. Insert the compression damper back into the damper tube and slide entire damper assembly into the tube. Press top cap firmly into place.

19. Holding damper tube with the open end up, pour 5wt suspension oil into the damper tube until tube is approximately half-full. Tap the compression damper tube lightly on a flat surface to release any air bubbles trapped inside the damper.

20. Pour additional 5wt suspension oil into damper tube until completely full.

21. Remove rebound damper and seal head from the oil container in which it was submerged. Wrap a rag around the damper tube to catch displaced oil. With the seal head bottomed out, slowly insert rebound piston into the damper tube, by pushing on the seal head, until it is fully seated. Wipe all oil from damper tube.

IMPORTANT: DO NOT CYCLE THE REBOUND DAMPER INTO THE DAMPER TUBE. THE COMPRESSION DAMPER IS NOT SECURE IN THE DAMPER TUBE UNTIL THREADED INTO THE UPPER AND TIGHTENED WITH A SOCKET WRENCH.

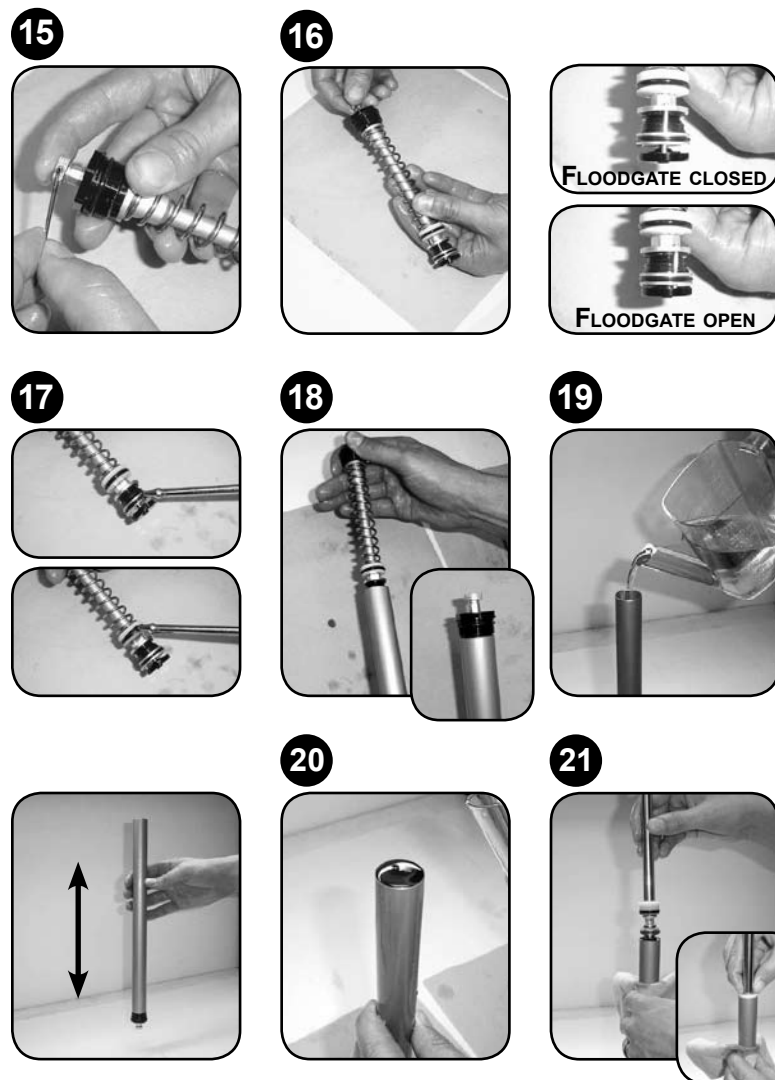

DAMPER INSTALLATION INSTRUCTIONS (CONT)

22. Inside the damper upper tube is an o-ring that sits between the damper tube/rebound seal head assembly and the upper tube thread base retainer. Ensure the o-ring is positioned flat on the threaded upper tube base retainer. If the o-ring came out with the damper tube assembly, apply a small amount of grease to the o-ring and re-position it on the bottom of the rebound damper seal head.
23. Insert the damper assembly back into the upper tube, rebound shaft first. Guide the end of the rebound damper through the center of the threaded base retainer, sliding the damper completely into the upper tube.
24. Hand thread the compression damper top cap into the upper tube. Use a 24mm socket wrench and tighten top cap to 60 in-lb. **IMPORTANT: DO NOT ALLOW REBOUND DAMPER SHAFT TO SCRAPE THE RETAINER UPON INSERTION.**

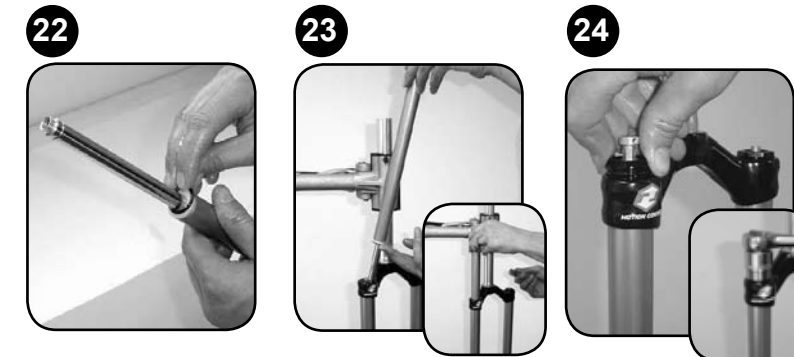

OPTIONAL - REMOTE ADJUST TO NON-REMOTE

Switching from a remote compression adjust to a crown mounted compression adjust requires only the removal of the remote spool and cable stop clamp assemblies, and installation of the standard compression adjuster knob. Unlike standard Motion Control compression dampers, the 07 SID Motion Control compression damper remote return spring is NOT integrated into the damper assembly. The remote PopLoc or PushLoc lever adjuster can either be removed from the handlebar, or simply remove the cable/cable housing and leave the PopLoc or PushLoc lever on your handlebar, in case you choose to re-install the remote spool in the future.

DAMPER INSTALLATION INSTRUCTIONS (CONT)

25. Remove Floodgate adjuster knob again, using a 1.5mm hex wrench (not pictured)
26. Place cable stop clamp onto the top cap with the cable stop positioned at approximately 90° forward from the steerer tube. Turn the compression spool adjuster shaft (hex shaped) counterclockwise until it stops, to ensure it is in the open (unlocked) position.
27. Place the remote spool onto the compression spool adjuster shaft and turn clockwise until it stops, in the closed (lockout) position. Hold the remote spool in the closed position and use your free hand to rotate the cable stop clamp counterclockwise until it touches the remote spool stop.
28. Tighten cable stop clamp with a 2.5mm hex wrench. Check the position of the remote spool by rotating it counterclockwise to the full open (unlocked) position. The set screw should be in line with the open mark on the cable stop clamp.

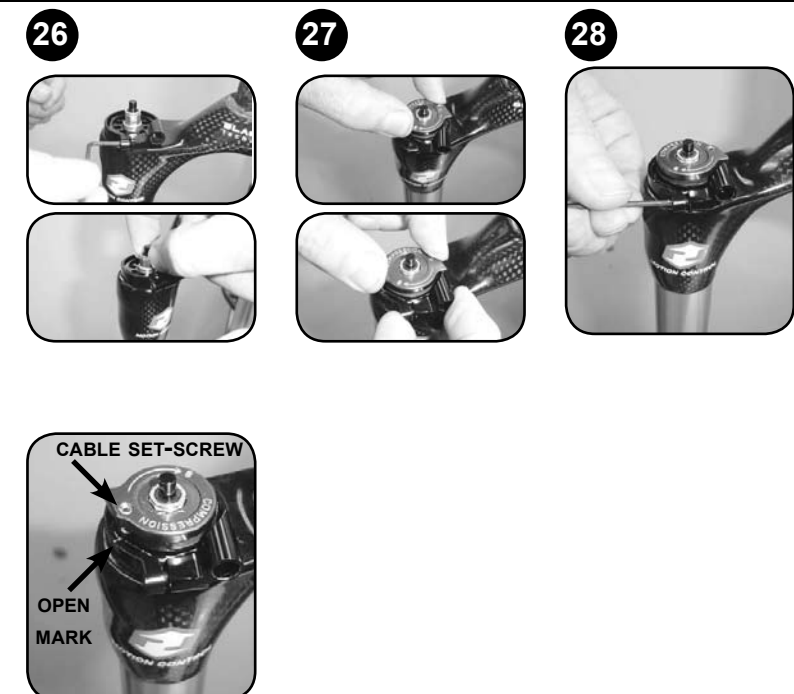

DAMPER INSTALLATION INSTRUCTIONS (CONT)

29. Remove the remote spool while the compression adjuster is in the open (unlock) position. Apply a small amount of grease to the remote spool return spring (grease will hold the return spring in the remote spool during installation). Insert the return spring into the underside of the remote spool, with the long spring leg facing out.
30. Place the remote spool and return spring onto the compression damper adjuster hex by aligning the long leg of the return spring to fit into one detent hole in the top cap, at the same time as aligning the cable set screw with the open mark on the cable stop clamp.
31. Turn the remote spool clockwise until spool-stop rests in the closed position against the cable stop clamp stop. If the stop on the remote spool does not touch the stop on the cable stop clamp, loosen cable stop clamp and rotate it counterclockwise until the two stops touch and retighten cable stop clamp. Release the spool from the close position and test the return to the open position. Using external snap ring pliers, secure the remote spool with a new snap ring.
31. Place the Floodgate adjuster knob back onto the compression damper spool shaft. Tighten the Floodgate adjuster knob set screw to the flat surface of the black adjuster rod with a 1.5mm hex wrench.

29



30



31



32



33



THIS CONCLUDES THE DAMPER SERVICE FOR YOUR FORK. YOU DID A GREAT JOB! YOU ARE NOW READY TO MOVE ONTO THE NEXT SECTION, SPRING SERVICE. ENJOY!

PURE DELITE DAMPER SERVICE (SID RACE)

INTRODUCTION

At this point you should already have the lowers removed from your fork. If not, you will need to return to the Lower Leg Removal section of this manual and follow the instructions for removing your fork lowers.

DAMPER REMOVAL/SERVICE INSTRUCTIONS

IMPORTANT: VERIFY ALL AIR PRESSURE IS REMOVED FROM THE PURE DELITE AIR CHAMBER BEFORE PROCEEDING. REMOVE AIR VALVE COVER CAP AND DEPRESS SCHRADER VALVE TO RELEASE ANY AIR PRESSURE.

1. Unthread compression damper top cap with a 24mm socket wrench.
2. Pull up and remove the entire Pure Delite damper assembly from the upper tube. Remove the top cap by pulling out of the Pure Delite damper tube.
3. Invert the damper assembly and gently, but firmly, pull the rebound damper seal head assembly from the Pure tube. Hold a rag around tube while pulling, to catch any oil that may spill. Pour any remaining oil from the Pure tube into oil pan.
4. Remove the Internal Floating Piston (IFP), which is located inside the Pure damper tube, in the center of the tube. The IFP is the seal that separates the oil from the air in the Delite air chamber. To remove the IFP, insert a long dowel rod (plastic or wood) into the Pure tube until the rod touches the underside of the IFP. Push firmly on the rod to release the IFP from the Pure tube.

IMPORTANT: BE CAREFUL NOT TO SCRATCH THE INSIDE OF THE PURE TUBE WITH THE DOWEL ROD. SCRATCHES WILL CAUSE OIL/AIR TO LEAK AND THE PURE DELITE DAMPER SYSTEM WILL NOT FUNCTION PROPERLY.

5. Review the Pure Delite Damper assembly components.
6. Remove IFP inner and outer o-rings. Apply a few drops of suspension oil to new o-ring and re-install (not pictured).
7. Slide seal head off rebound damper shaft and remove inner and outer seal head o-rings. Apply a few drops of suspension oil to new o-rings and re-install. Inspect damper shaft for scratches and replace if damaged. Place seal head back onto rebound damper shaft.

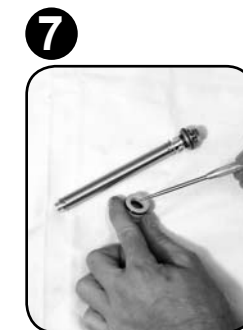
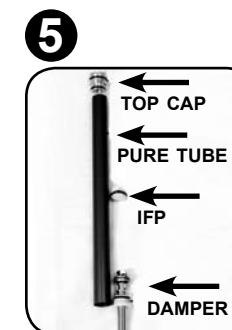
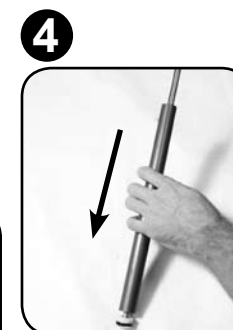
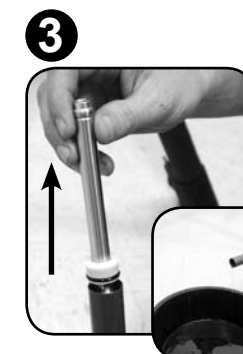
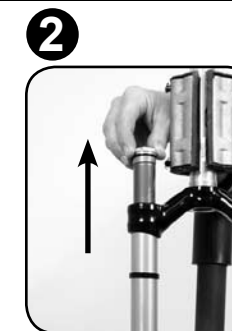

DAMPER INSTALLATION INSTRUCTIONS

9. Insert IFP in the Pure tube at a depth of 6 inches. To do this, mount a long dowel rod (plastic or wood) into a bicycle stand clamp or bench vice with 6 inches of exposed rod. Place the IFP on the end of the dowel, pocketed side down. Place one end of the Pure Tube over the IFP and press firmly down until the IFP is seated inside the tube.

9

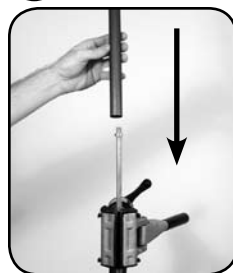

10



11



12

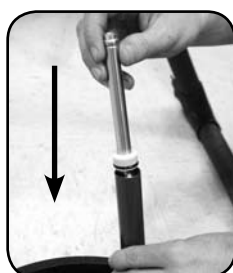

13

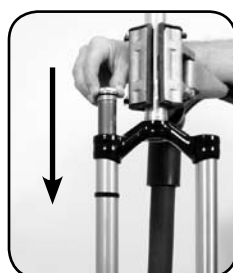

10. Continue to press the IFP into the Pure tube until the tube end is flush against the bicycle clamp or vice. The IFP is now seated firmly inside the Pure tube at a 6 inch depth. Pull the Pure tube off the dowel.

11. Hold the Pure tube over oil pan, with the pocketed side of the IFP facing down (rounded side facing up) and fill the tube completely with 15wt suspension oil.

12. Make sure the rebound damper is in the open position. Gently and slowly insert the rebound damper piston head into the oil filled Pure tube. The oil will slowly fill the damper valves (some oil may spill). Allow enough oil to fill the damper valve cavities and top off oil volume if necessary. With the seal head bottomed out, gently press down on the seal head until it snaps into the Pure tube securely. Your damper is now sealed.

14



15



16



- NOTE: BE SURE PISTON SEAL HEAD IS TOPPED AGAINST REBOUND PISTON.**

- IMPORTANT: DO NOT CYCLE THE DAMPER SHAFT UNTIL THE DELITE AIR TOP CAP HAS BEEN INSTALLED AND PRESSURIZED.**

13. Insert the Pure Delite damper assembly into the upper tube through the crown.

14. Add 6cc/ml of 15wt suspension oil to the top chamber of the damper. This will lubricate the IFP o-ring.

15. Hand thread the damper top cap into the upper tube. Use a 24mm socket wrench and tighten top cap to 60 in-lb. Pressurize the air chamber with your shock pump to 20-60psi. The IFP is now pressure set and your damper sealed.

16. Insert the rebound damper external adjuster knob into the bottom of the rebound damper shaft and turn clockwise until damper is in the full closed position. This will protect the damper rod when installing the lower leg shaft bolt.

THIS CONCLUDES THE DAMPER SERVICE FOR YOUR FORK. YOU DID A GREAT JOB! YOU ARE NOW READY TO MOVE ONTO THE NEXT SECTION, SPRING SERVICE. ENJOY!

MISSION CONTROL DAMPER SERVICE (LYRIK - TOTEM)

INTRODUCTION

At this point you should already have the lowers removed from your fork. If not, you will need to return to the Lower Leg Removal section of this manual and follow the instructions for removing your fork lowers.

DAMPER REMOVAL/SERVICE INSTRUCTIONS

1. Turn blue high speed compression knob clockwise, to set in the maximum compression position.
2. Unthread compression damper top cap with a thin 24mm wrench. Access to the top cap is under the high speed compression knob.

1



2



OR

- OR
- Loosen and remove the gold low speed compression knob by gently grasping the low speed compression knob with slip joint pliers and using a 4mm hex wrench to remove low speed compression screw. Lift and remove the low speed compression knob. Then, loosen and remove both retaining bolts on the high speed compression knob, using a 1.5mm hex wrench. Again, lift and remove the high speed compression knob. This allows access to the top cap. Unthread compression damper top cap using a 24mm socket wrench.



3. Remove compression damper from upper tube/crown by pulling up and twisting side to side. Once removed, clean upper tube threads with a rag.

3

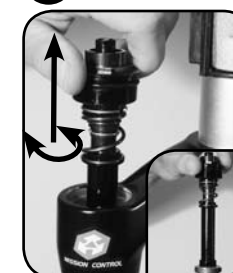

4



5



4. Remove glide ring from compression damper piston assembly. Apply a few drops of suspension oil to new glide ring and re-install.

5. Remove fork from bicycle stand and pour remaining oil into pan. Return fork to bicycle stand.

6. Remove rebound damper seal head retaining ring (located inside the bottom of the right upper tube), using internal snap ring pliers. Pull down and remove the rebound damper assembly from the upper tube.

6



7

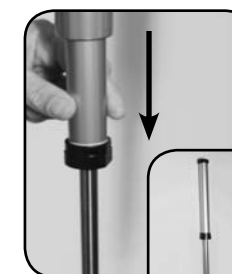

7. Push upward on rebound shaft to separate rebound piston assembly from rebound tube.

8. Spray rebound damper shaft with isopropyl alcohol, and clean with a rag (not pictured).

DAMPER REMOVAL/SERVICE INSTRUCTIONS (CONT)

9. Remove inner and outer o-rings from rebound seal head. Apply a few drops of suspension oil to new o-rings and re-install. **IMPORTANT: IF USING A PICK TO REMOVE INNER SEAL HEAD O-RING, DO NOT SCRATCH O-RING GLAND. SCRATCHES MAY CAUSE OIL TO LEAK.**
10. Remove glide ring from rebound shaft assembly. Apply a few drops of suspension oil to new glide ring and re-install.



DAMPER INSTALLATION INSTRUCTIONS

11. Install rebound shaft assembly into rebound tube. **NOTE: BE SURE NOT TO DAMAGE REBOUND TUBE INNER O-RING.**
12. Install rebound assembly into upper tube and secure with retaining ring using internal snap ring pliers. **IMPORTANT: MAKE SURE THE RETAINING RING IS SECURELY FASTENED IN THE UPPER TUBE GROOVE. YOU CAN CHECK THIS BY USING THE SNAP RING PLIERS TO ROTATE THE RETAINING RING IN THE SHAFT ONE COMPLETE REVOLUTION.**
13. Pull rebound damper shaft down into the fully extended position.
14. Measure and pour 5wt suspension oil into the upper tube, through the crown, using the following volumes:

FORK	OIL VOLUME (±3cc/ML)
LYRIK	112cc/ML*
TOTEM	137cc/ML

IMPORTANT: OIL VOLUME IS CRITICAL. TOO MUCH OIL REDUCES AVAILABLE TRAVEL, WHICH CAN LEAD TO FORK DAMAGE FROM COMPRESSION BOTTOM OUT. TOO LITTLE OIL DECREASES DAMPING PERFORMANCE.

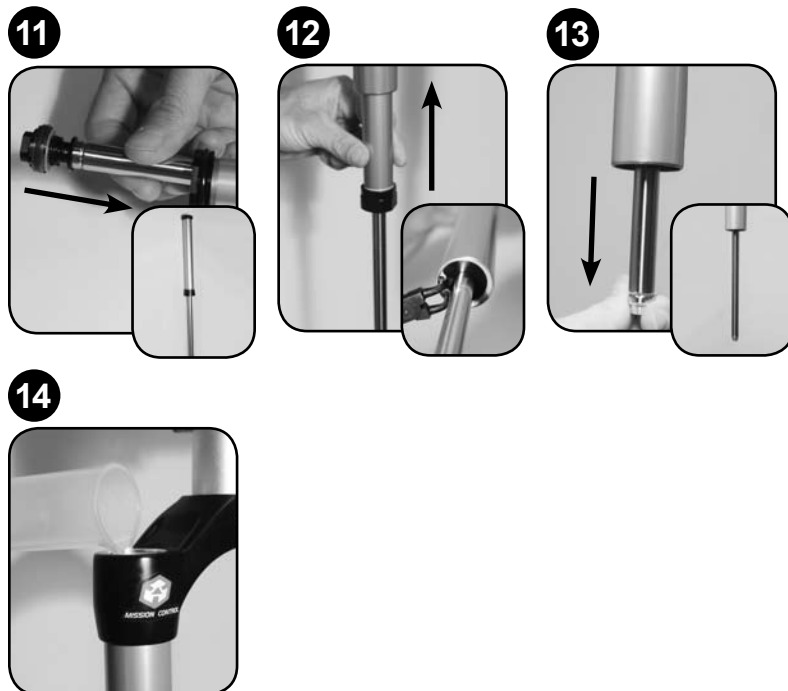

DAMPER INSTALLATION INSTRUCTIONS (CONT)

15. Turn Floodgate to "off" position by pushing low speed compression adjuster down and rotating counterclockwise 90°. Install Mission Control damper assembly into upper tube through the crown. Hand thread the compression damper top cap into the upper tube. Use a thin 24mm socket wrench and tighten top cap to 60 in-lb.

OR

Insert Mission Control damper assembly into upper tube through the crown. Hand thread the compression damper top into the upper tube. Use a 24mm socket wrench and tighten top cap to 60 in-lb. Install high speed compression knob using a 1.5mm hex wrench to tighten screws. Install low speed compression knob by gently grasping the knob with slip joint pliers and using a 4mm hex wrench to tighten screw.

THIS CONCLUDES THE DAMPER SERVICE FOR YOUR FORK. YOU DID A GREAT JOB! YOU ARE NOW READY TO MOVE ONTO THE NEXT SECTION, SPRING SERVICE. ENJOY!

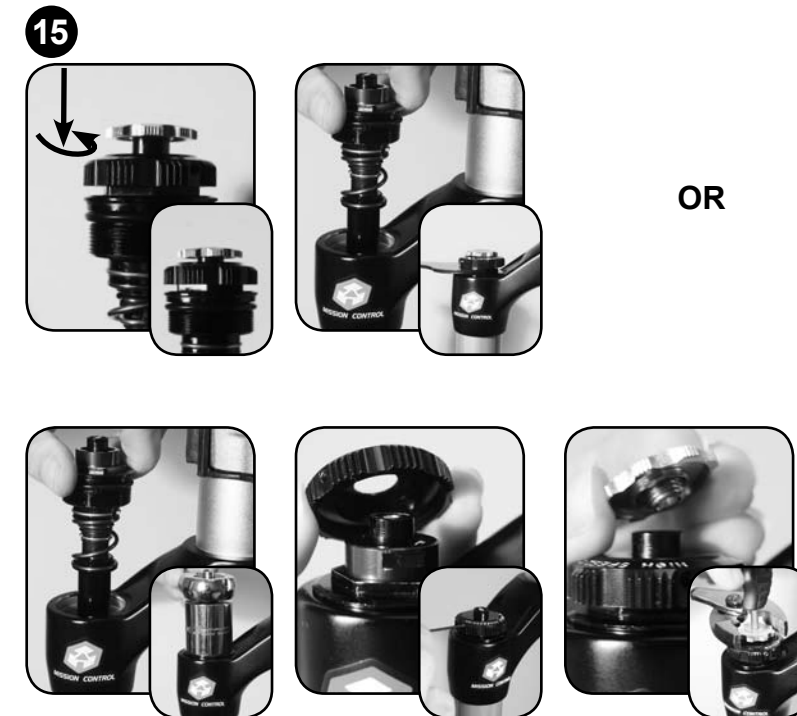

SPRING SERVICE



COIL SPRING SERVICE

(ARGYLE 302, 318 - DART 1, 2, 2 (WITH TURNKEY) 3 - DOMAIN 302, 318 - TORA 289, 302, 318)

INTRODUCTION

At this point you should already have the lowers removed from your fork. If not, you will need to return to the Lower Leg Removal section of this manual and follow the instructions for removing your fork lowers.

COIL SPRING REMOVAL/SERVICE INSTRUCTIONS

1. Unthread and remove spring top cap with a 24mm socket wrench.
IMPORTANT: PRESS DOWN FIRMLY WHEN LOOSENING TOP CAP.
2. Argyle 302, 318 Only: Remove spring pre-load spacer(s).
3. Push spring shaft upward, from the bottom of the upper tube, then remove spring and spring spacers from upper tube.
4. Turn fork upside down and slide the spring shaft assembly out of the upper tube. Remove spring shaft assembly and inspect for damage.
5. Spray isopropyl alcohol on spring, spring shaft assembly and the inside and outside of the upper tube and wipe with a clean rag. Wrap a clean rag around a long dowel and insert into the upper tube to clean inside the upper tube (not pictured).

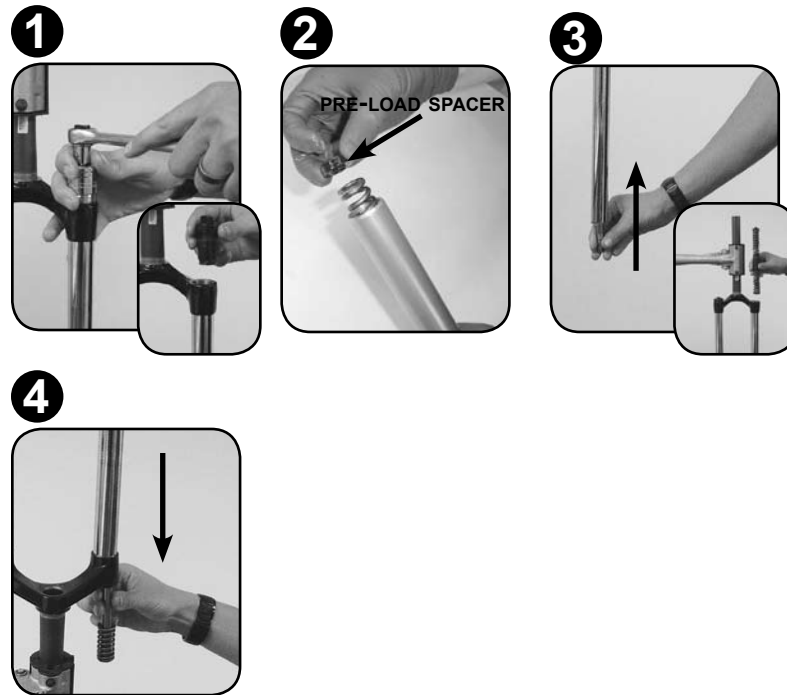

COIL SPRING INSTALLATION INSTRUCTIONS

5. Insert and drop spring shaft assembly into upper tube through the crown. Guide the threaded end through the shaft guide at the bottom of the upper tube and gently pull shaft through to full extension.
6. Apply fresh grease liberally to spring/spring spacer assembly.
7. Insert and drop spring assembly into upper tube through the crown.
8. Argyle 302, 318 Only: Install spring pre-load spacers.
9. Clean top cap, then apply a small amount of grease to top cap threads. Insert top cap into upper tube/crown and hand thread into upper tube. Using a 24mm socket wrench, tighten to 60 in-lb.

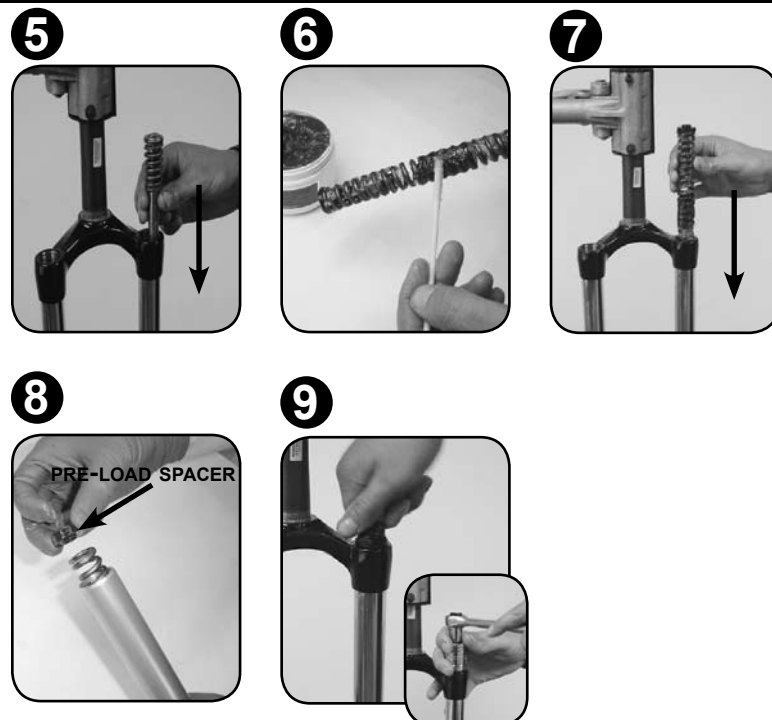

THIS CONCLUDES THE SPRING SERVICE FOR YOUR FORK. YOU DID A GREAT JOB! YOU ARE NOW READY TO MOVE ONTO THE NEXT SECTION, LOWER LEG INSTALLATION. ENJOY!

COIL SPRING SERVICE

(BOXXER RACE, TEAM - RECON 327, 335, 351 - TOTEM)

INTRODUCTION

At this point you should already have the lowers removed from your fork. If not, you will need to return to the Lower Leg Removal section of this manual and follow the instructions for removing your fork lowers.

SPRING REMOVAL/SERVICE INSTRUCTIONS

1. Unthread and remove spring top cap with a 24mm socket wrench.
IMPORTANT: PRESS DOWN FIRMLY WHEN LOOSENING TOP CAP.
2. Remove spring pre-load spacer(s) and pull spring from upper tube.
3. Remove the spring shaft base plate retaining ring using internal snap ring pliers.
4. Pull spring shaft and base plate from upper tube. Inspect assembly for damage and replace entire assembly if necessary.
5. Spray isopropyl alcohol on spring, spring isolators (isolators are BoXXer only), spring shaft and the inside and outside of the upper tube and wipe with a clean rag. Wrap a clean rag around a long dowel and insert into the upper tube to clean inside the upper tube (not pictured).

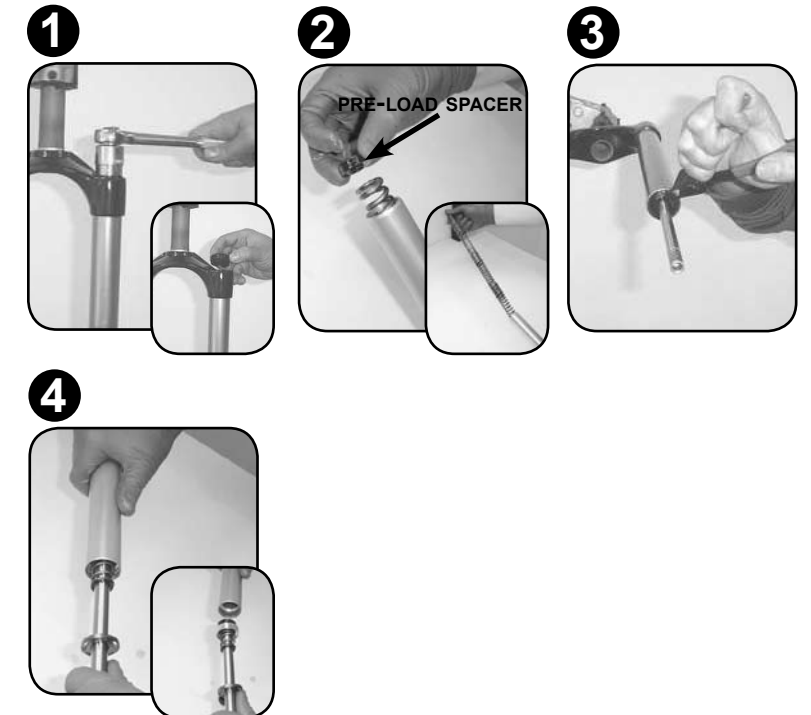

COIL SPRING INSTALLATION INSTRUCTIONS

6. Insert spring shaft assembly back into bottom of upper tube so the base plate assembly is seated into the upper tube step. Secure spring shaft assembly with retaining ring, using internal snap ring pliers.
7. Apply fresh grease liberally to spring and spring isolators (isolators are BoXXer only).
8. Insert spring back into upper tube and place spring preload spacer(s) on top of spring inside upper tube.
9. Clean top cap, then apply a small amount of grease to top cap threads. Insert top cap into upper tube/crown and hand thread into upper tube. Using a 24mm socket wrench, tighten to 60 in-lb.

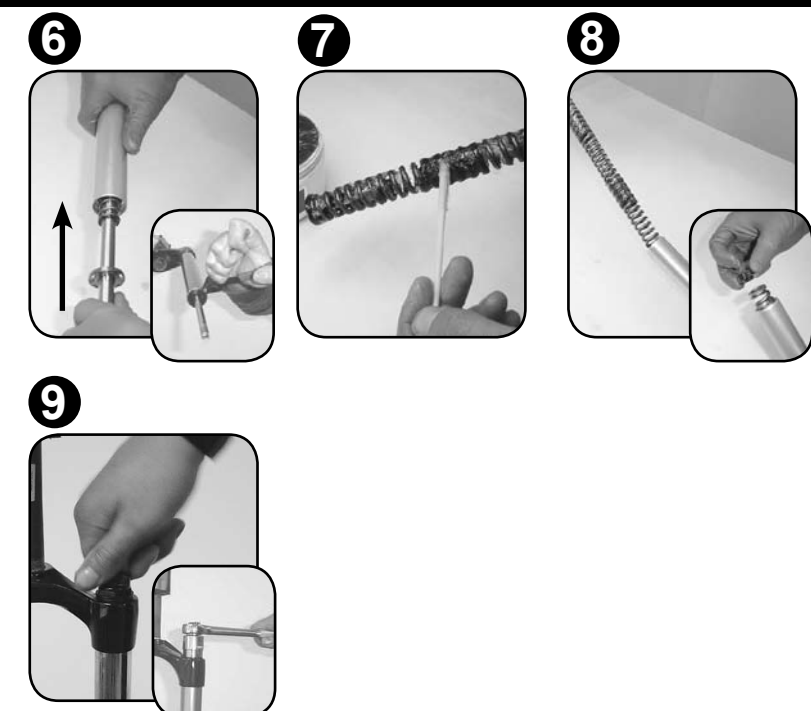

THIS CONCLUDES THE SPRING SERVICE FOR YOUR FORK. YOU DID A GREAT JOB! YOU ARE NOW READY TO MOVE ONTO THE NEXT SECTION, LOWER LEG INSTALLATION. ENJOY!

COIL U-TURN SPRING SERVICE

(DOMAIN 302, 318 - TORA 289, 302, 318)

INTRODUCTION

At this point you should already have the lowers removed from your fork. If not, you will need to return to the Lower Leg Removal section of this manual and follow the instructions for removing your fork lowers.

COIL U-TURN SPRING REMOVAL/SERVICE INSTRUCTIONS

1. Remove U-Turn knob screw with a 2.5mm hex wrench and remove U-Turn adjuster knob.
2. Remove detent ball bearings and detent springs from top cap using a magnet.
3. Unthread and remove spring top cap with a 24mm socket wrench. The spring is attached to the top cap and spring shaft. Pull and lift entire spring assembly from upper tube.
IMPORTANT: PRESS DOWN FIRMLY WHEN LOOSENING TOP CAP.
4. Remove U-Turn negative spring assembly from upper tube, you may need to turn fork upside down to remove.
5. Spray isopropyl alcohol on entire spring assembly, negative spring, and the inside and outside of the upper tube and wipe with a clean rag. Wrap a clean rag around a long dowel and insert into the upper tube to clean inside the upper tube (not pictured).

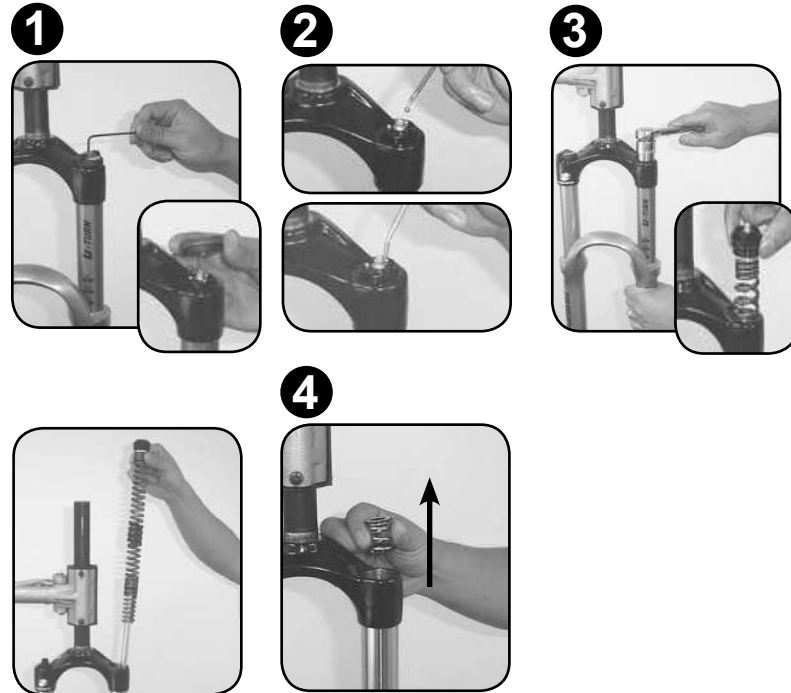

COIL U-TURN SPRING INSTALLATION INSTRUCTIONS

6. Apply fresh grease liberally to negative spring, the entire spring assembly, and top cap threads.
7. Insert and drop negative spring into upper tube through the crown.
8. Insert U-Turn spring assembly into upper tube through crown, shaft end first. Align and seat the spring shaft through the shaft guide/base plate.
9. Insert top cap into upper tube/crown and hand thread into upper tube. Using a 24mm socket wrench, tighten to 60 in-lb.
10. Using a magnet, insert each detent spring into top cap detent holes, evenly spaced. Place each detent ball bearing on top of each detent spring.
11. Place U-Turn adjuster knob on top of hex. Tighten U-Turn knob screw with a 2.5mm hex wrench.

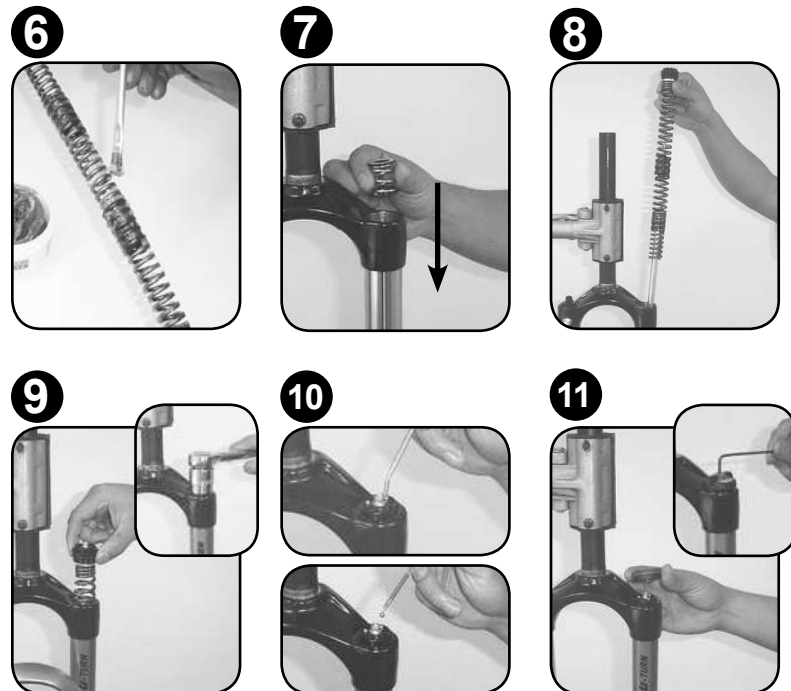

THIS CONCLUDES THE SPRING SERVICE FOR YOUR FORK. YOU DID A GREAT JOB! YOU ARE NOW READY TO MOVE ONTO THE NEXT SECTION, LOWER LEG INSTALLATION. ENJOY!

COIL U-TURN SPRING SERVICE

(LYRIK - PIKE 409, 426, 454 - RECON 327, 351 - REVELATION 426)

INTRODUCTION

At this point you should already have the lowers removed from your fork. If not, you will need to return to the Lower Leg Removal section of this manual and follow the instructions for removing your fork lowers.

COIL U-TURN SPRING REMOVAL/SERVICE INSTRUCTIONS

1. Remove U-Turn knob screw with a 2.5mm hex wrench and remove U-Turn adjuster knob.
2. Remove detent ball bearings and detent springs from top cap using a magnet.
3. Unthread and remove spring top cap with a 24mm socket wrench. The spring is attached to the top cap and spring shaft. Pull and lift entire spring assembly from upper tube.
IMPORTANT: PRESS DOWN FIRMLY WHEN LOOSENING TOP CAP.
4. Spray isopropyl alcohol on entire spring assembly and the inside and outside of the upper tube and wipe with a clean rag. Wrap a clean rag around a long dowel and insert into the upper tube to clean inside the upper tube (not pictured).

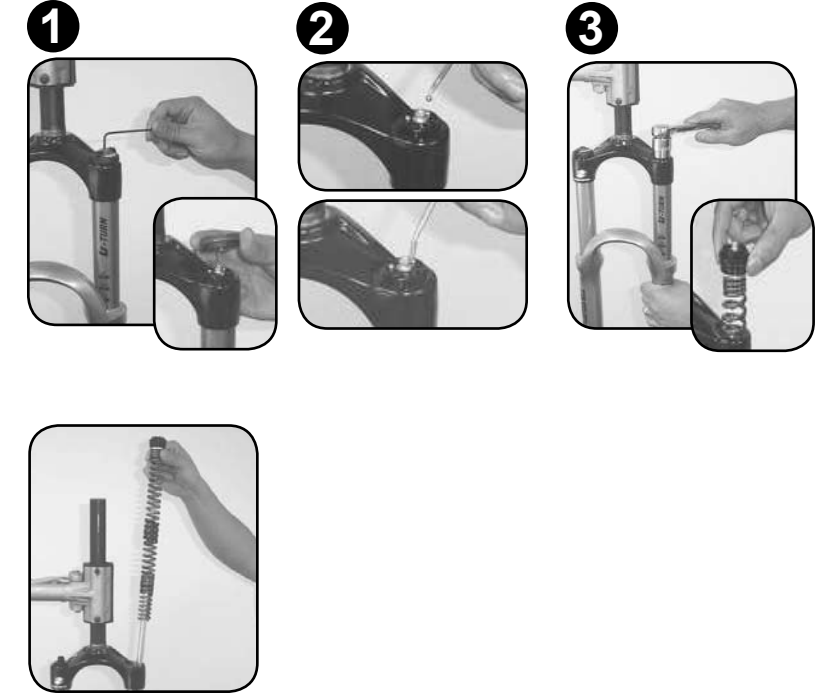

COIL U-TURN SPRING INSTALLATION INSTRUCTIONS

5. Apply fresh grease liberally to the entire spring assembly, and top cap threads.
6. Insert U-Turn spring assembly into upper tube through crown, shaft end first. Align and seat the spring shaft through the shaft guide/base plate.
7. Insert top cap into upper tube/crown and hand thread into upper tube. Using a 24mm socket wrench, tighten to 60 in-lb.
8. Using a magnet, insert each detent spring into top cap detent holes, evenly spaced. Place each detent ball bearing on top of each detent spring.
9. Place U-Turn adjuster knob on top of hex. Tighten U-Turn knob screw with a 2.5mm hex wrench.

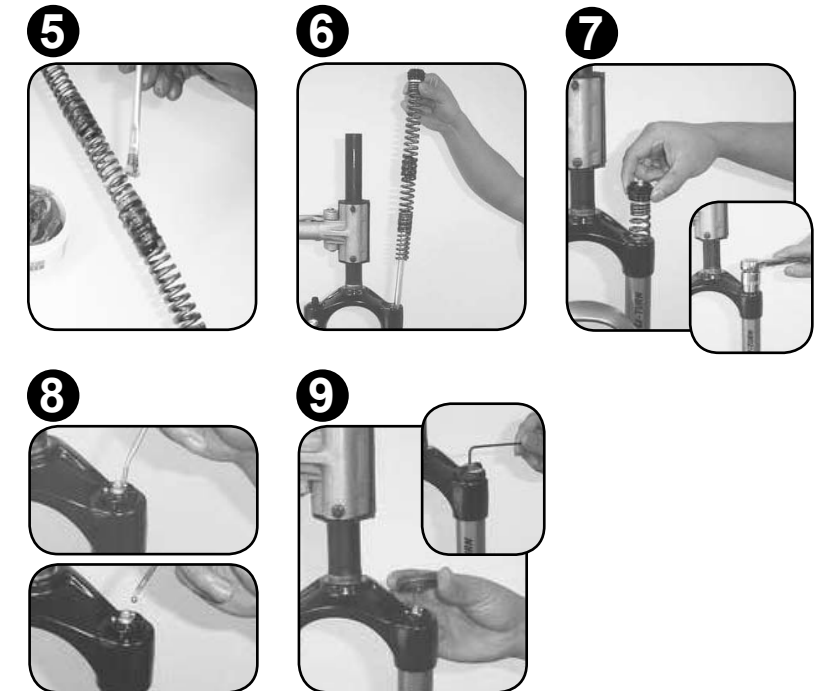

THIS CONCLUDES THE SPRING SERVICE FOR YOUR FORK. YOU DID A GREAT JOB! YOU ARE NOW READY TO MOVE ONTO THE NEXT SECTION, LOWER LEG INSTALLATION. ENJOY!

SOLO AIR SPRING SERVICE

(ARGYLE 409 - RECON 335, 351- TORA 318)

INTRODUCTION

At this point you should already have the lowers removed from your fork. If not, you will need to return to the Lower Leg Removal section of this manual and follow the instructions for removing your fork lowers.

SOLO AIR SPRING REMOVAL/SERVICE INSTRUCTIONS

IMPORTANT: VERIFY ALL AIR PRESSURE IS REMOVED FROM THE AIR CHAMBER BEFORE PROCEEDING.

DEPRESS SCHRADER VALVE AGAIN TO REMOVE ANY REMAINING AIR PRESSURE.

1. Unthread air spring top cap with a 24mm socket wrench. The air spring assembly is attached to the top cap. Pull and lift entire air spring assembly from upper tube.
2. Pull top cap out of air tube assembly and pour any air seal lubricant into oil pan.
3. Remove air shaft and air seal head from the bottom of the air tube by pulling shaft down and twisting side to side.
4. Spray isopropyl alcohol on the inside and outside of the upper tube and wipe with a clean rag. Wrap a clean rag around a long dowel and insert into the upper tube to clean inside the upper tube (not pictured).
5. Remove air piston retainer ring using external snap ring pliers. Then remove air piston wavy spring washer and piston from air shaft.
6. Slide air sleeve seal head assembly from air shaft.
7. Remove inner and outer seal head o-rings. Apply a few drops of suspension oil to new o-rings and re-install.
IMPORTANT: IF USING A PICK TO REMOVE O-RINGS, DO NOT SCRATCH SEAL HEAD. SCRATCHES MAY CAUSE OIL TO LEAK.
8. Spray air shaft with isopropyl alcohol and wipe clean with a rag (not pictured).
9. Insert air piston back onto air shaft head. Install spring wavy washer onto air shaft end and secure in place with air piston retainer ring, using external snap ring pliers. Check retaining ring fit to make sure it secures the air piston to air shaft head. The piston should compress slightly with spring resistance against wavy spring washer and retaining ring.

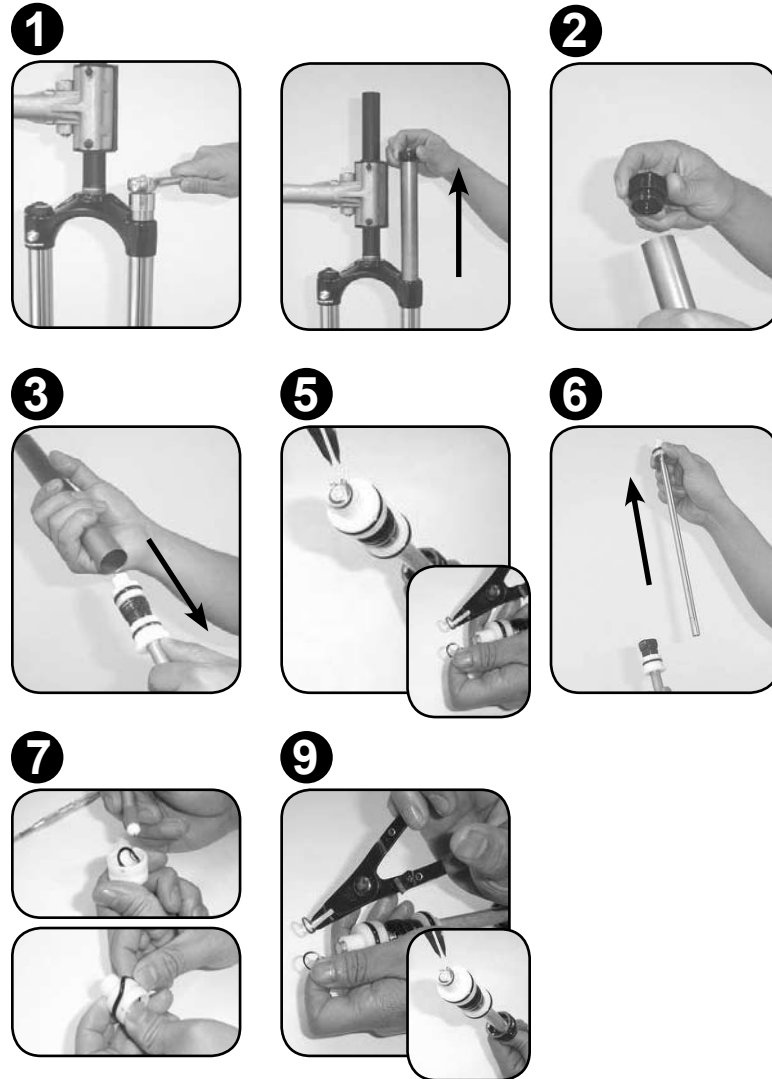

SOLO AIR SPRING REMOVAL/SERVICE INSTRUCTIONS (CONT)

10. Remove bottom-out bumper and pad from negative air sleeve/seal head.
11. Remove inner and outer seal head o-rings. Apply a few drops of suspension oil to new o-rings and re-install.

IMPORTANT: IF USING A PICK TO REMOVE O-RINGS, DO NOT SCRATCH SEAL HEAD. SCRATCHES MAY CAUSE OIL TO LEAK.

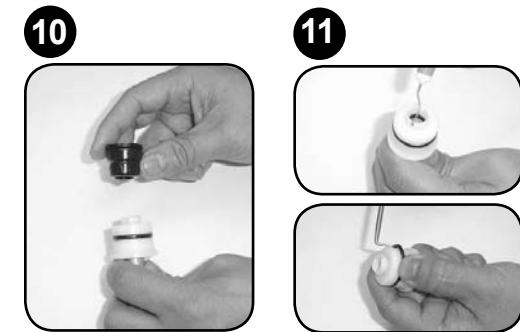

OPTIONAL - ALL TRAVEL CONFIGURATIONS (TORA 318)

All travel spacers are located just above the air seal head. If you want to change the travel of your fork, snap the travel spacer onto seal head to decrease travel, or remove to increase travel.

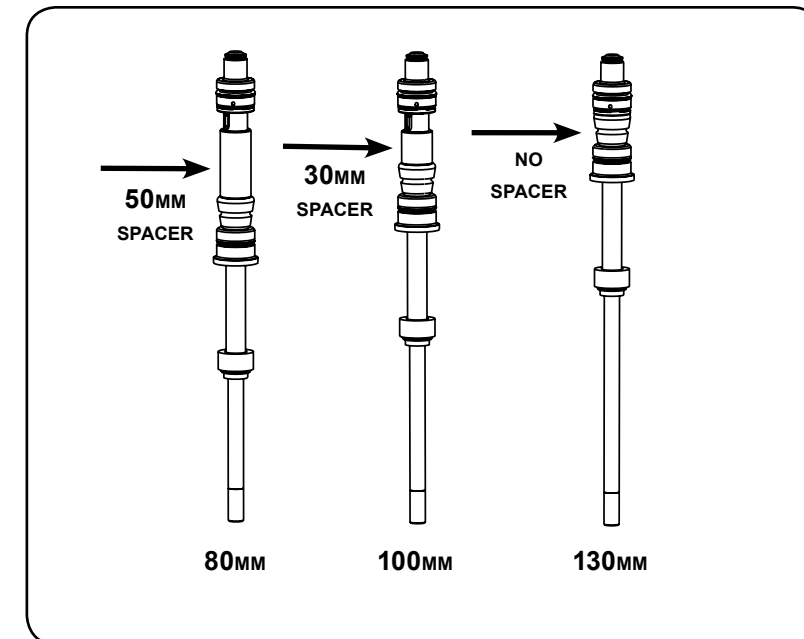

SOLO AIR SPRING INSTALLATION INSTRUCTIONS

12. Insert bottom-out bumper and pad back onto air seal head. Slide air seal head/sleeve assembly back into air shaft, bumpers first.
13. Insert lubricated air assembly, both pistons and air sleeve into one end of air tube. Push air seal head into air tube until firmly seated.
14. Insert air shaft into top of upper tube, through crown. Guide the bottom of the air shaft through the shaft guide in the bottom of the upper tube. Insert air tube assembly into upper tube until it rests inside upper tube.
15. Measure and pour 6cc/ml of 15wt suspension oil into upper tube through the crown. Suspension oil in the air chamber lubricates the air seal o-ring during use and maintains the air seal.
16. Push air shaft to lift air tube out of upper tube a couple of inches. Insert the air top cap into air tube and press tight into air tube.
17. Drop air tube/top cap assembly into upper tube. Check bottom of upper tube and make sure air shaft guide is seated into upper tube shaft guide.
18. Insert top cap into upper tube/crown and hand thread into upper tube. Using a 24mm socket wrench, tighten to 60 in-lb.

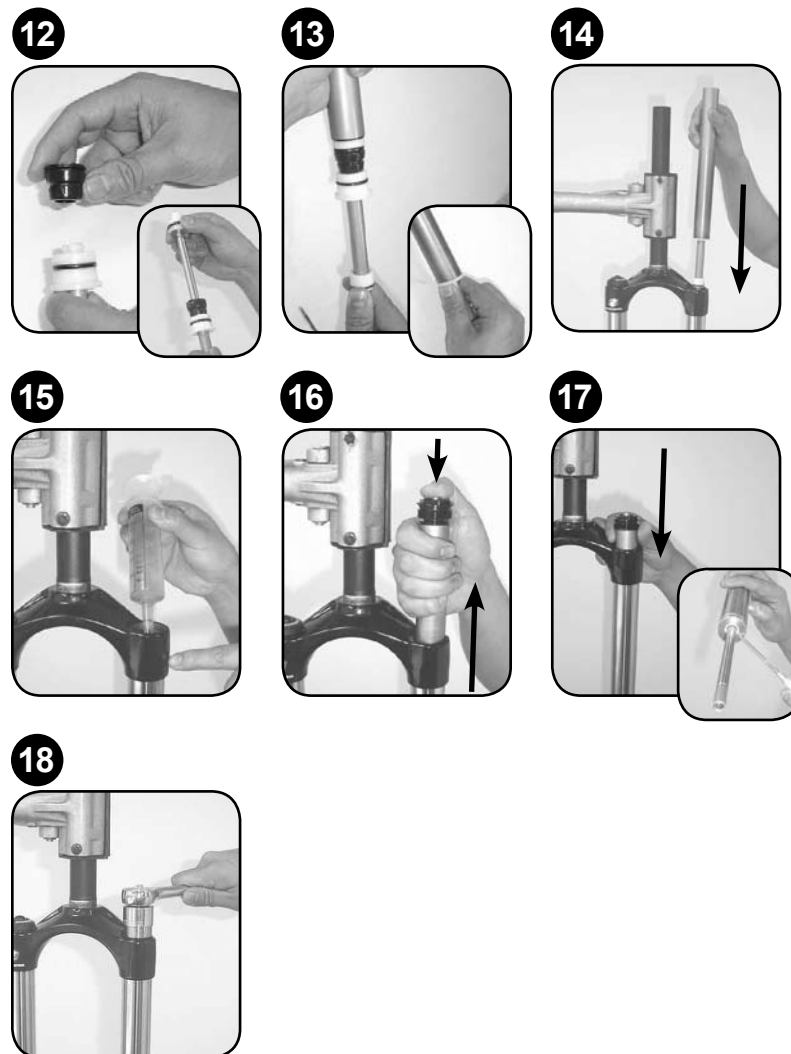

THIS CONCLUDES THE SPRING SERVICE FOR YOUR FORK. YOU DID A GREAT JOB! YOU ARE NOW READY TO MOVE ON TO THE NEXT SECTION, LOWER LEG INSTALLATION. ENJOY!

SOLO AIR SPRING SERVICE (BOXXER WC - LYRIK - RECON 327, 335, 351 - TOTEM)

INTRODUCTION

At this point you should already have the lowers removed from your fork. If not, you will need to return to the Lower Leg Removal section of this manual and follow the instructions for removing your fork lowers.

SOLO AIR SPRING REMOVAL/SERVICE INSTRUCTIONS

IMPORTANT: VERIFY ALL AIR PRESSURE IS REMOVED FROM THE AIR CHAMBER BEFORE PROCEEDING. DEPRESS SCHRADER VALVE AGAIN TO REMOVE ANY REMAINING AIR PRESSURE.

1. Unthread and remove air spring top cap with a 24mm socket wrench. Remove fork from stand and pour any air seal lubricant into oil pan.
2. Use your finger to press the air seal head into the upper tube. You will feel it break free and slide into the tube about 3mm.
3. Remove the air assembly shaft guide retaining ring from the bottom of the left upper tube, using external snap ring pliers. Pull air shaft down to remove air spring assembly and shaft guide from upper tube.
4. Spray isopropyl alcohol on the inside and outside of the upper tube and wipe with a clean rag. Wrap a clean rag around a long dowel and insert into the upper tube to clean inside the upper tube (not pictured).

NOTE: FOR LYRIK, AND TOTEM IT IS NOT NECESSARY TO PERFORM STEPS 5, 6, 7 OR 9. SIMPLY INSPECT RETAINER RING AND WAVY WASHER (AND CUSHION ON LYRIK AND TOTEM). IF DAMAGED, YOU WILL NEED TO REPLACE THE AIR PISTON HEAD ASSEMBLY. OTHERWISE PLEASE COMPLETE STEP 8, THEN MOVE ON TO STEP 11.

5. Remove air piston retainer ring using external snap ring pliers. Then remove air piston wavy spring washer and piston from air shaft.
6. Slide air sleeve/seal head assembly from air shaft.
7. Remove inner and outer seal head o-rings. Apply a few drops of suspension oil to new o-rings and re-install.
IMPORTANT: IF USING A PICK TO REMOVE O-RINGS, DO NOT SCRATCH SEAL HEAD. SCRATCHES MAY CAUSE OIL TO LEAK.
8. Spray air shaft with isopropyl alcohol and wipe clean with a rag (not pictured).

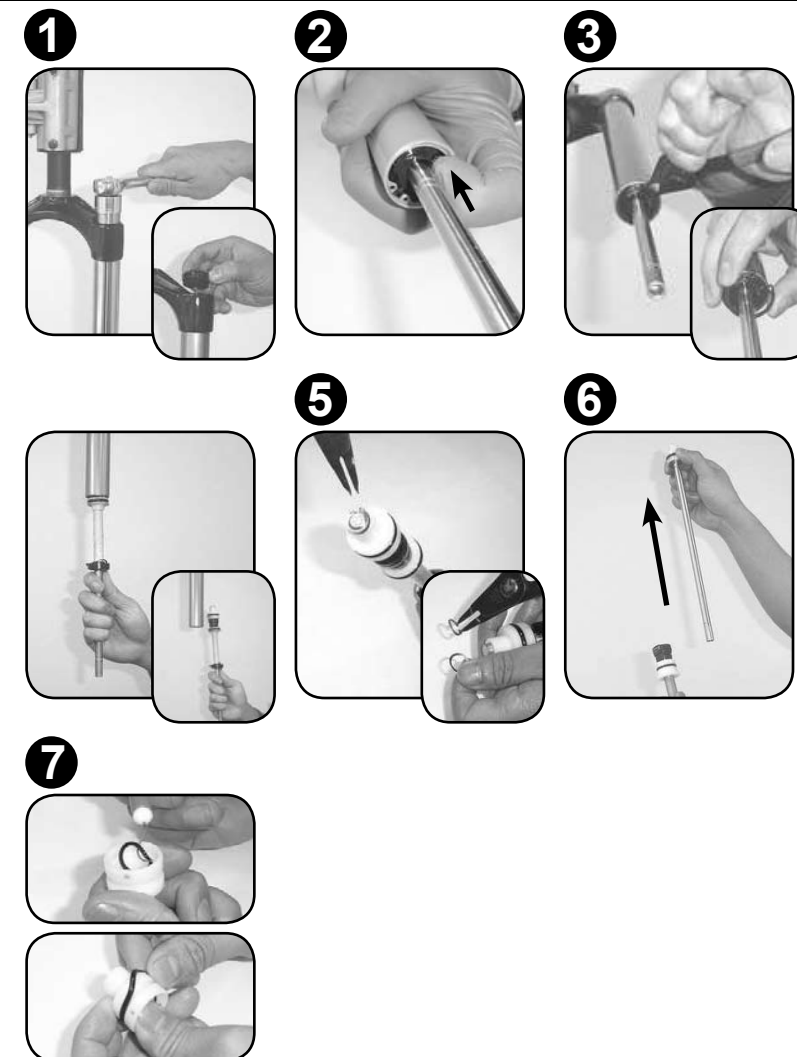

SOLO AIR SPRING REMOVAL/SERVICE INSTRUCTIONS (CONT)

9. Insert air piston back onto air shaft head. Install spring wavy washer onto air shaft end and secure in place with air piston retaining ring, using external snap ring pliers. Check retaining ring fit to make sure it secures the air piston to air shaft head. The piston should compress slightly with spring resistance against wavy spring washer and retaining ring.
10. Remove bottom-out bumper and pad from negative air sleeve/seal head.
11. Remove inner and outer seal head o-rings. Apply a few drops of suspension oil to new o-rings and re-install.

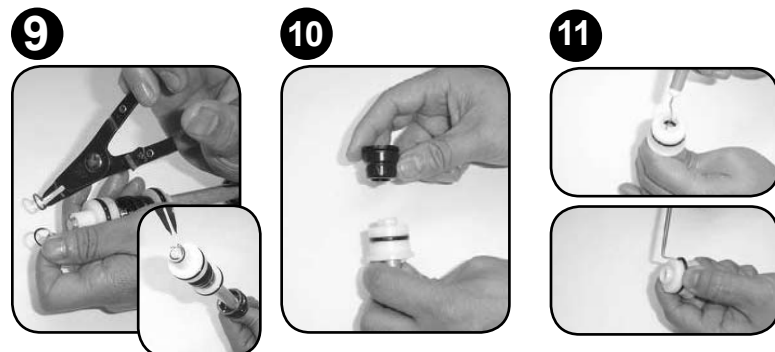

IMPORTANT: IF USING A PICK TO REMOVE O-RINGS, DO NOT SCRATCH SEAL HEAD. SCRATCHES MAY CAUSE OIL TO LEAK.

OPTIONAL - ALL TRAVEL CONFIGURATIONS (RECON 327, 335, 351)

All travel spacers are located just above the air seal head. If you want to change the travel of your fork, snap the travel spacer onto seal head to decrease travel, or remove to increase travel.

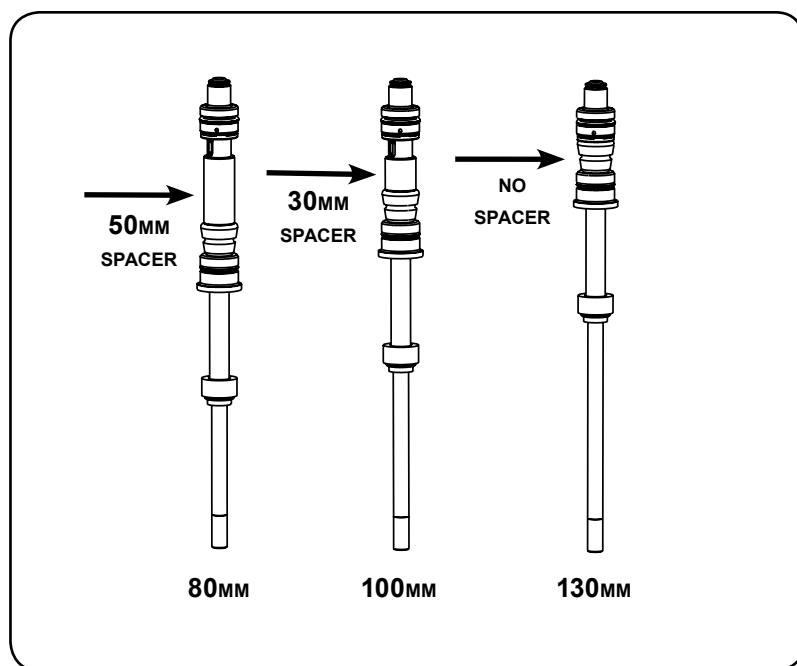

SOLO AIR SPRING INSTALLATION INSTRUCTIONS

12. Insert bottom-out bumper and pad back onto air seal head. Slide air seal head/sleeve assembly back into air shaft, bumpers first.
13. Insert lubricated air piston into bottom of upper tube and slide the lower air piston/sleeve assembly into upper tube.
14. Seat the shaft guide ring and wavy washer into upper tube step, then slide negative air sleeve into upper tube and seat shaft guide base into upper tube step.
15. Secure retaining ring into upper tube retaining ring groove using external snap ring pliers. Position retaining ring holes around retaining ring positioner on base plate. Verify retaining ring is secure in upper tube.
16. Measure and pour 6cc/ml of 15wt suspension oil into air tube through the crown. Suspension oil in the air chamber lubricates the air seal o-ring during use and maintains the air seal.
17. Insert top cap into upper tube/crown and hand thread into upper tube. Using a 24mm socket wrench, tighten to 60 in-lb.

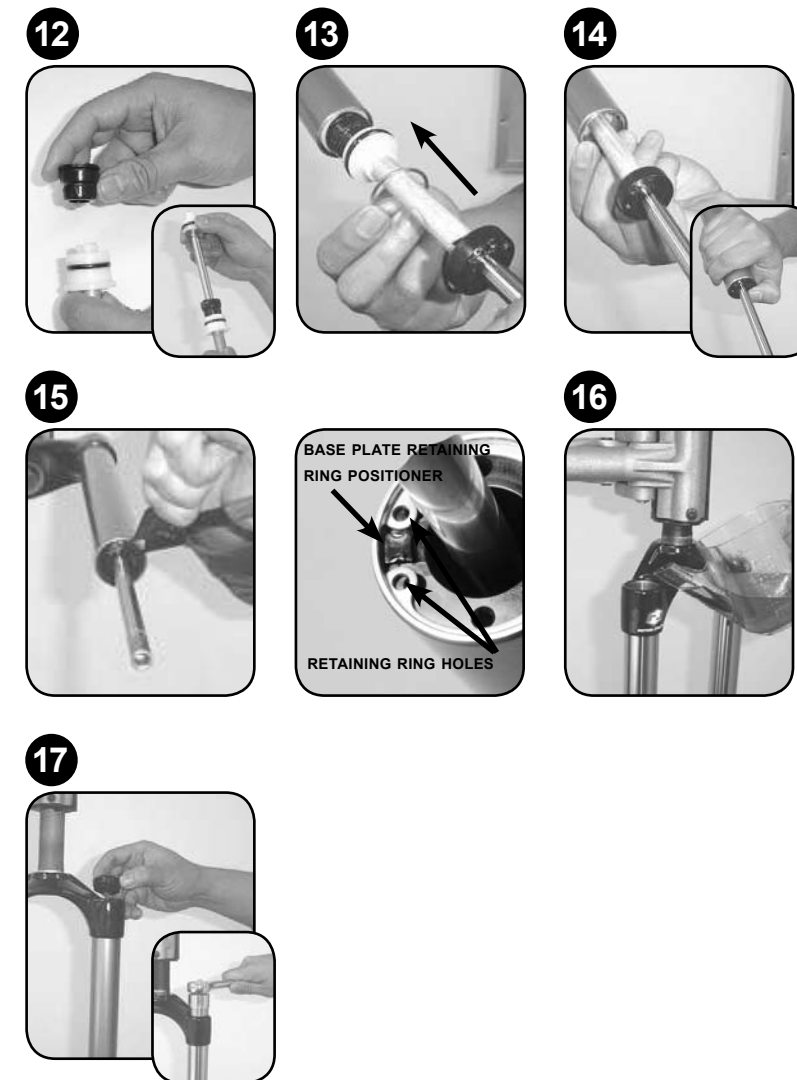

THIS CONCLUDES THE SPRING SERVICE FOR YOUR FORK. YOU DID A GREAT JOB! YOU ARE NOW READY TO MOVE ONTO THE NEXT SECTION, LOWER LEG INSTALLATION. ENJOY!

DUAL AIR SPRING SERVICE

(PIKE 409, 426 - REBA SL, RACE, TEAM, WC - REVELATION 409, 426)

INTRODUCTION

At this point you should already have the lowers removed from your fork. If not, you will need to return to the Lower Leg Removal section of this manual and follow the instructions for removing your fork lowers.

DUAL AIR SPRING REMOVAL/SERVICE INSTRUCTIONS

IMPORTANT: VERIFY ALL AIR PRESSURE IS REMOVED FROM THE AIR CHAMBER BEFORE PROCEEDING. DEPRESS POSITIVE AND NEGATIVE SCHRADER VALVES AGAIN TO REMOVE ANY REMAINING AIR PRESSURE.

1. Unthread and remove Dual Air top cap with a 24mm socket wrench.
2. Remove fork from stand and pour any air seal lubricant into oil pan.
3. Clamp fork back into bicycle stand and wipe shaft and base plate with a rag.
4. Push negative air shaft up and into base plate, leaving only the tip of the threaded shaft end protruding from base valve.

NOTE: YOU MAY NEED TO DEPRESS THE SCHRADER VALVE AS YOU PUSH THE SHAFT, TO PREVENT A VACUUM.

5. Slide a 15mm socket tool (or similar hollow tool) over the air shaft end and press firmly against the base plate. While pressing the air base plate up and into the upper tube, remove the retaining ring using external snap ring pliers.
6. Once retaining ring is removed, gently pull air shaft down to remove air spring assembly and base plate from upper tube.
7. Spray isopropyl alcohol on the inside and outside of the upper tube and wipe with a clean rag. Wrap a clean rag around a long dowel and insert into the upper tube to clean inside the upper tube (not pictured).
8. Remove base plate, base plate o-ring/bumper, and negative air piston from the Dual Air shaft.
9. Remove outer and inner negative air piston o-rings. Apply a few drops of suspension oil to new o-rings and re-install.

IMPORTANT: IF USING A PICK TO REMOVE O-RINGS, DO NOT SCRATCH SEAL HEAD. SCRATCHES MAY CAUSE OIL TO LEAK.

10. Remove outer positive air piston o-ring. Apply a few drops of suspension oil to new o-ring and re-install.

IMPORTANT: IF USING A PICK TO REMOVE O-RING, DO NOT SCRATCH SEAL HEAD. SCRATCHES MAY CAUSE OIL TO LEAK.

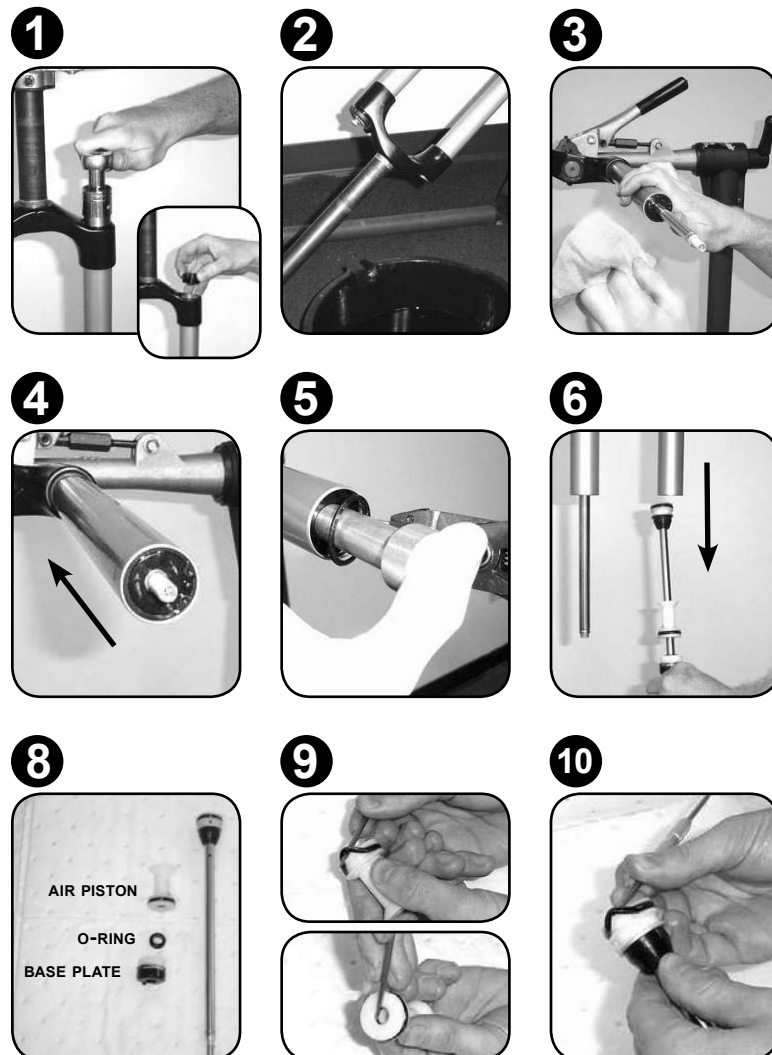

OPTIONAL - ALL TRAVEL CONFIGURATIONS

All travel spacers are located just above the bottom out bumper washer. If you want to change the travel of your fork, snap the travel spacer onto the Dual Air shaft to decrease travel, or remove to increase travel.

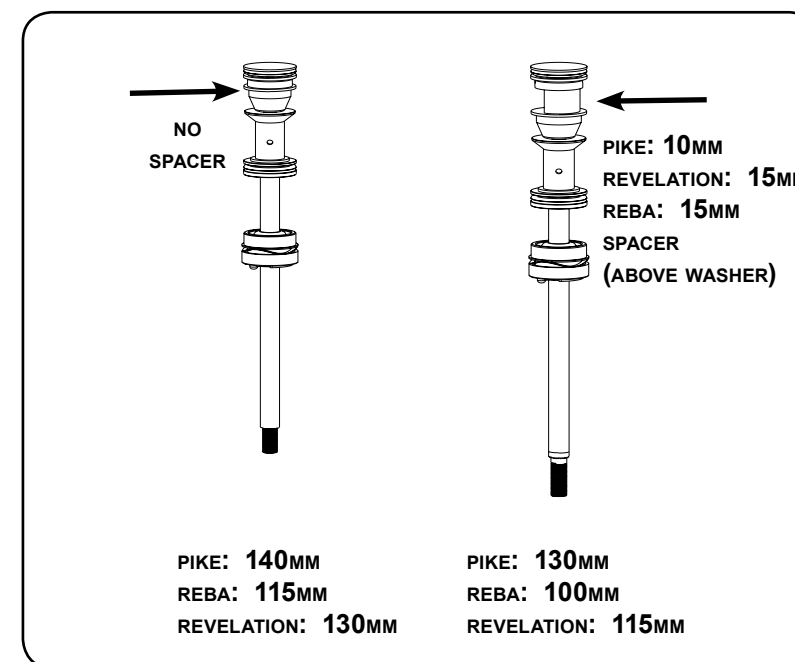

DUAL AIR SPRING INSTALLATION INSTRUCTIONS

11. Re-install the negative air piston, base plate o-ring/bumper and base plate onto the Dual Air shaft and re-apply suspension oil to o-rings.
12. Insert Dual Air assembly into upper tube, positive air piston first, followed by the negative air piston. Insert base plate assembly into upper tube step and press in firmly.
13. Using your thumb, press base plate into upper tube. While pressing base plate, install external retaining ring using external snap ring pliers. Verify retaining ring is secure in upper tube groove. Align retaining ring according to the orientation of the base plate retaining ring groove.
14. Measure and pour 6cc/ml of 15wt suspension oil into air tube through crown. Suspension oil in the air chamber lubricates the air seal o-ring during use and maintains the air seal.
15. Insert top cap into upper tube/crown and hand thread into upper tube. Using a 24mm socket wrench, tighten to 60 in-lb.

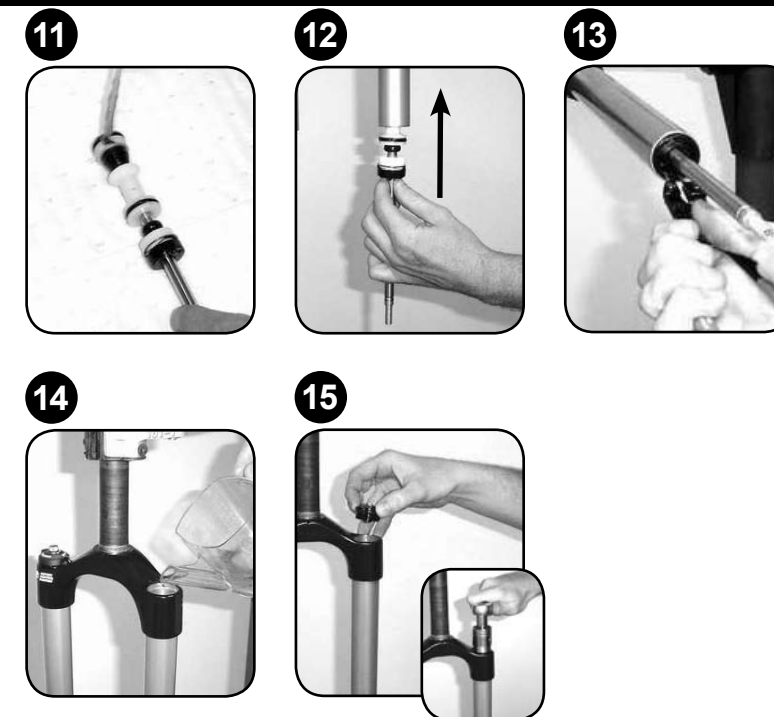

THIS CONCLUDES THE SPRING SERVICE FOR YOUR FORK. YOU DID A GREAT JOB! YOU ARE NOW READY TO MOVE ONTO THE NEXT SECTION, LOWER LEG INSTALLATION. ENJOY!

DUAL AIR SPRING SERVICE

(SID RACE, TEAM, WC)

INTRODUCTION

At this point you should already have the lowers removed from your fork. If not, you will need to return to the Lower Leg Removal section of this manual and follow the instructions for removing your fork lowers.

DUAL AIR SPRING REMOVAL/SERVICE INSTRUCTIONS

IMPORTANT: VERIFY ALL AIR PRESSURE IS REMOVED FROM THE AIR CHAMBER BEFORE PROCEEDING. DEPRESS POSITIVE AND NEGATIVE SCHRADER VALVES AGAIN TO REMOVE ANY REMAINING AIR PRESSURE.

1. Unthread and remove Dual Air spring top cap with a 24mm socket wrench.
2. Remove fork from stand and pour any oil from positive air chamber into oil pan.
3. Remove threaded upper tube retainer using the SID Dual Air upper tube retainer tool and a socket wrench.

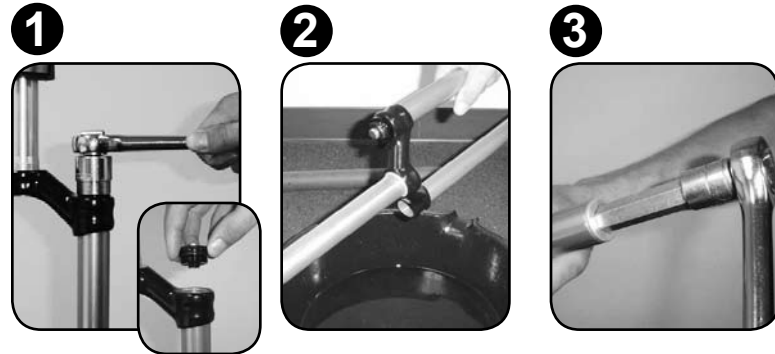

IMPORTANT: THE RETAINER IS REVERSE THREADED. TURN THE WRENCH CLOCKWISE TO UNTHREAD.

4. Pull Dual Air spring shaft assembly from upper tube.

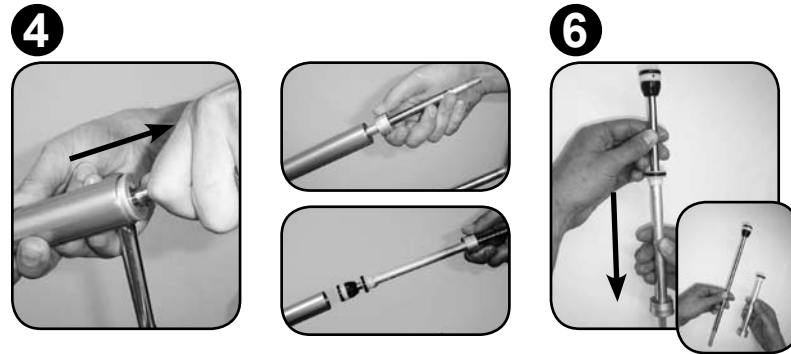

NOTE: YOU MAY NEED TO DEPRESS THE NEGATIVE SCHRADER VALVE AS YOU PULL THE DUAL AIR SHAFT; PRESSURE BUILDS UP AS YOU PULL.

5. Spray isopropyl alcohol on the inside and outside of the upper tube and wipe with a clean rag. Wrap a clean rag around a long dowel and insert into the upper tube to clean inside the upper tube (not pictured).

IMPORTANT: LOOK INSIDE THE UPPER TUBE USING A LIGHT AND CHECK FOR SCRATCHES. IF THE INSIDE SURFACE OF THE UPPER TUBE IS SCRATCHED, REPLACE THE ASSEMBLY. SCRATCHES CAN CAUSE AIR BYPASS AND EFFECT THE PERFORMANCE OF YOUR FORK.

6. Slide the negative air piston sleeve from air spring shaft.
7. Spray isopropyl alcohol on the air shaft and wipe with a clean rag (not pictured).
8. Remove the outer and inner negative air piston o-rings as well as the outer positive air piston o-ring. Apply a few drops of suspension oil to new o-rings and re-install.



IMPORTANT: IF USING A PICK TO REMOVE O-RINGS, DO NOT SCRATCH SEAL HEAD. SCRATCHES MAY CAUSE OIL TO LEAK.

9. Slide negative air spring sleeve back onto air spring shaft.

OPTIONAL - ALL TRAVEL CONFIGURATIONS

All travel spacers are located just above the negative sleeve top out bumper. To change the travel of your fork, slide negative sleeve down and snap the travel spacer onto seal head to decrease travel, or remove to increase travel.

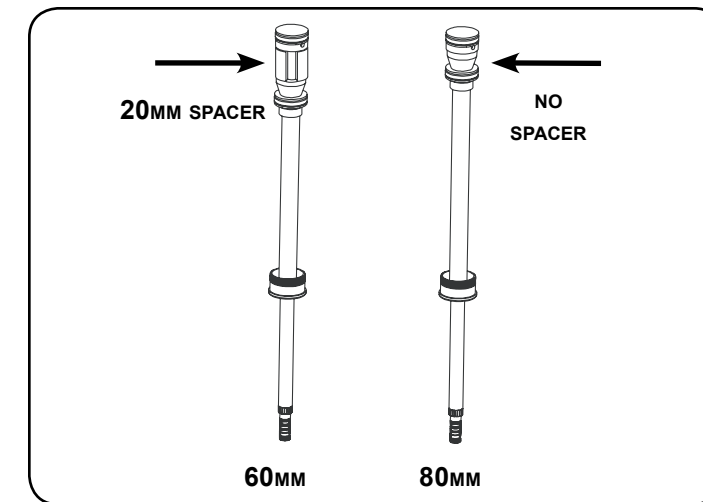

DUAL AIR SPRING INSTALLATION INSTRUCTIONS

10. Re-apply fresh suspension oil to new positive and negative air piston o-rings.

11. Insert positive air piston into bottom of upper tube and push air piston/shaft assembly into upper tube.

12. Slide the negative air piston sleeve down air spring shaft and into the bottom of the upper tube. Continue to slide entire negative air spring sleeve into upper tube.

NOTE: YOU MAY NEED TO DEPRESS THE NEGATIVE SCHRADER AIR VALVE AS YOU PUSH THE NEGATIVE SLEEVE INTO THE UPPER TUBE TO RELEASE THE AIR PRESSURE BUILD UP AND AID IN INSTALLATION.

13. Thread Dual Air spring assembly threaded base retainer into the upper tube by hand. Using the SID Dual Air upper tube retainer tool and a socket wrench, press into retainer firmly and tighten the threaded upper tube/base retainer to 30 in-lb.

IMPORTANT: THE RETAINER IS REVERSE THREADED. TURN BY HAND AND WRENCH COUNTER-CLOCKWISE TO THREAD.

14. Make sure fork is positioned upright in workstand. Measure and pour 6cc/ml of 15wt suspension oil into positive air chamber, through the crown.

NOTE: SUSPENSION OIL ON TOP OF THE POSITIVE AIR PISTON O-RING IS CRITICAL TO LUBRICATION AND MAINTENANCE OF THE AIR SEAL.

15. Insert top cap into upper tube/crown and hand thread into upper tube. Using a 24mm socket wrench, tighten to 60 in-lb.

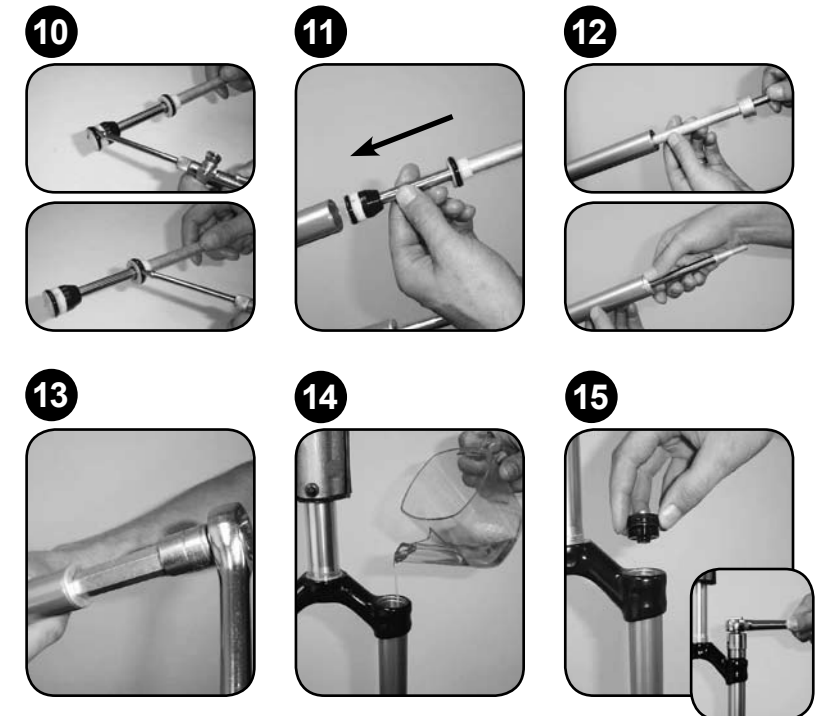

THIS CONCLUDES THE SPRING SERVICE FOR YOUR FORK. YOU DID A GREAT JOB! YOU ARE NOW READY TO MOVE ONTO THE NEXT SECTION, LOWER LEG INSTALLATION. ENJOY!

AIR U-TURN SPRING SERVICE

(PIKE 409, 429 - REBA RACE, TEAM - REVELATION 409, 429)

INTRODUCTION

At this point you should already have the lowers removed from your fork. If not, you will need to return to the Lower Leg Removal section of this manual and follow the instructions for removing your fork lowers.

AIR U-TURN SPRING REMOVAL/SERVICE INSTRUCTIONS

IMPORTANT: VERIFY ALL AIR PRESSURE IS REMOVED FROM THE AIR CHAMBER BEFORE PROCEEDING. DEPRESS POSITIVE AND NEGATIVE SCHRADER VALVES AGAIN TO REMOVE ANY REMAINING AIR PRESSURE.

1. Adjust travel setting to max (full) travel. Push external retaining clip from above U-Turn knob with a pick or screwdriver and remove adjuster knob.

2. Remove detent ball bearings and detent springs from top cap using a magnet.

IMPORTANT: IT IS **NOT** NECESSARY TO REMOVE THE U-TURN TOP CAP TO SERVICE THE AIR U-TURN SPRING ASSEMBLY. IN THE EVENT THE TOP CAP MUST BE REMOVED, UNTHREAD WITH A 24MM SOCKET WRENCH. BEFORE RE-INSTALLING TOP CAP, CLEAN OLD THREAD-LOCK OFF TOP CAP. THEN ADD A FEW DROPS OF BLUE THREAD-LOCK TO THE TOP CAP THREADS AND TIGHTEN WITH SOCKET WRENCH TO 60 IN-LB.

3. Turn Air U-Turn travel adjust shaft, which protrudes from both the center of the top cap and the bottom of the air shaft, CLOCKWISE to unthread the air spring assembly from the Air U-Turn top cap (top cap should be tight inside crown/upper tube).

4. Pull down on the Air U-Turn shaft and remove the entire spring assembly from the bottom of the upper tube.

5. Remove teflon washer from inside of top cap. To remove, push down with a pick or flat-head screwdriver. Washer will exit bottom of the upper tube.

6. Remove small external retaining ring located at the bottom of the air chamber using external snap ring pliers, then remove guide plate.

7. Push down on seal head with a flat-head screwdriver (position screwdriver head against step, away from shaft) and free the retaining ring from the seal head. Once seal head slides into air tube, remove seal head retaining ring, using snap ring pliers.

IMPORTANT: DO NOT SCRATCH AIR SHAFT.

SCRATCHES WITH CAUSE AIR TO LEAK AND EFFECT THE PERFORMANCE OF YOUR FORK.

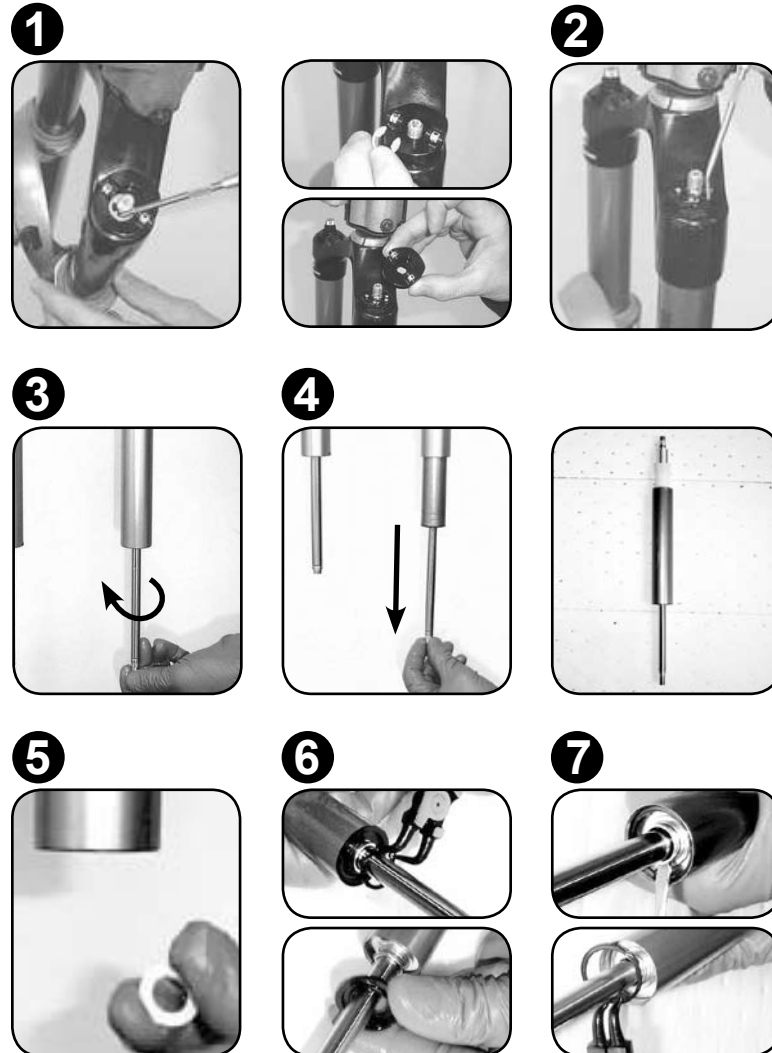

AIR U-TURN SPRING REMOVAL/SERVICE INSTRUCTIONS (CONT)

8. Pull air shaft, negative air seal head and positive air piston assemblies out of air tube. Slide and remove aluminum seal head from air shaft.

9. Spray isopropyl alcohol on air shaft and wipe with a clean rag (not pictured).

10. Remove seal head from air piston shaft. Remove the inner and outer seal head o-rings as well as the small outer o-ring located on the air piston shaft groove. Apply a few drops of suspension oil to new o-rings and re-install.

IMPORTANT: IF USING A PICK TO REMOVE O-RINGS, DO NOT SCRATCH SEAL HEAD OR O-RINGS. SCRATCHES WILL CAUSE PERMANENT AIR LEAK.

11. Holding the air tube, place upper choke assembly end of flat surface. Firmly press tube down on flat surface to break the seal and push choke assembly through tube.

NOTE: THE CHOKE ASSEMBLY WILL FEEL TIGHT INSIDE TUBE WHILE PUSHING CHOKE OUT OF AIR TUBE. YOU MAY NEED TO TAP THE END OF THE AIR SHAFT ONTO A FLAT WORKING SURFACE TO FREE THE UPPER AIR SPRING ASSEMBLY FROM THE AIR TUBE.

12. Use a non-metallic dowel to continue to push the assembly through and out of the air tube. Remove assembly completely from air tube.

IMPORTANT: USING A NON-METALLIC DOWEL HELPS TO ENSURE THE INSIDE OF THE AIR TUBE DOES NOT GET SCRATCHED.

13. Spray isopropyl alcohol on the inside and outside of the air tube and wipe with a clean rag. Wrap a clean rag around a long dowel and insert into the upper tube to clean inside the upper tube (not pictured).

14. Remove external choke retaining ring from travel adjustment shaft, using external snap ring pliers. Remove choke piston and choke/shaft washer.

15. Remove external choke o-ring. Apply a few drops of suspension oil to new o-ring and re-install.

IMPORTANT: IF USING A PICK TO REMOVE O-RING, DO NOT SCRATCH CHOKE PISTON. SCRATCHES MAY CAUSE AIR LEAK.

16. Remove upper seal head from adjuster shaft.

17. Use a flat head screwdriver and remove inner o-ring retaining ring. Then remove both the inner and outer seal head o-rings. Apply a few drops of suspension oil to new o-rings and re-install. Use a flat head screwdriver to re-install inner o-ring retaining ring.

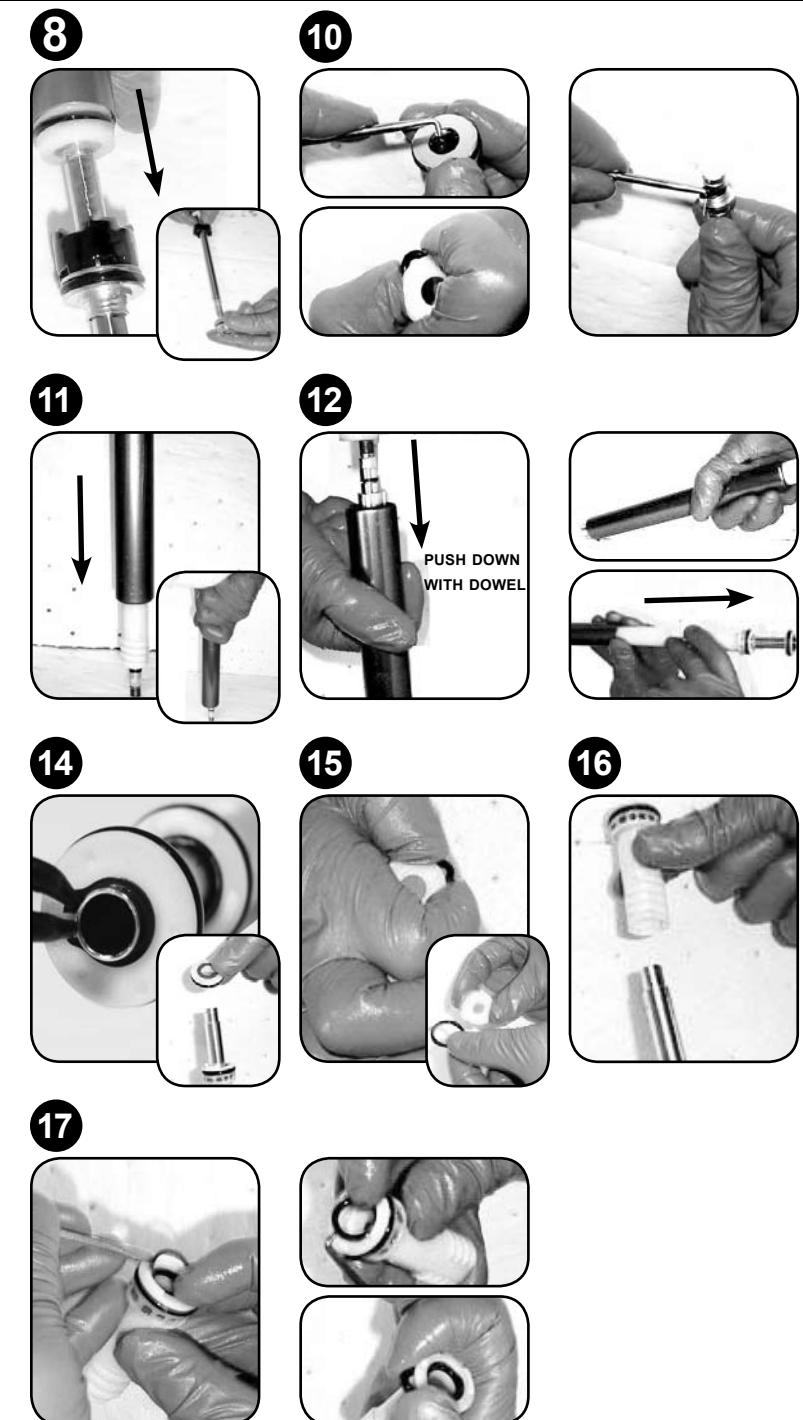

AIR U-TURN SPRING REMOVAL/SERVICE INSTRUCTIONS (CONT)

18. Re-install upper seal head onto travel adjustment shaft and apply suspension oil to adjuster shaft and inner seal head o-ring.
19. Install choke piston and secure with a NEW 10mm external retaining ring, using external snap ring pliers.
20. Apply suspension oil to both piston o-rings.

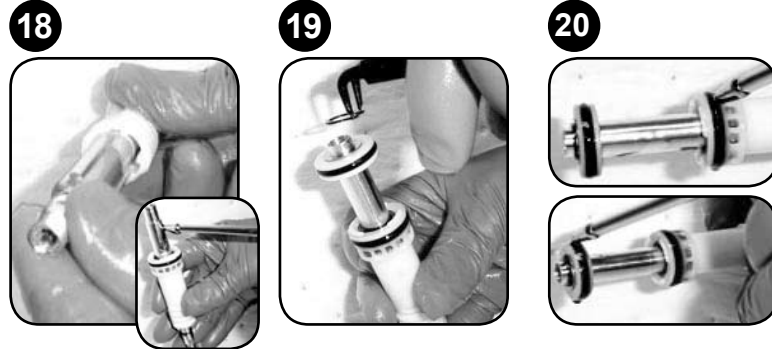

AIR U-TURN SPRING INSTALLATION INSTRUCTIONS

21. Apply a thin film of grease to the inside groove of the open end of the air spring tube. Insert the upper choke assembly into open end of air spring tube, schrader valve first, and press completely into air tube.
22. Using a long non-metallic dowel, push assembly up into the air tube until seated flush against the rolled end of the air tube.
23. Hold air tube with open end up. Measure and pour 6cc/ml of 15wt suspension oil into air tube/positive air chamber, on top of the upper choke assembly. This will lubricate the choke o-ring and positive air piston o-ring when fork is compressed. Set aside air tube, upright, so oil does not spill.
24. Re-apply suspension oil to inner seal head o-ring and slide negative air seal head onto Dual Air shaft, flat end first. Slide up to bottom out bumper.
25. Re-apply suspension oil to positive and negative air piston o-rings and insert positive air piston into open end of air spring. Push air shaft assembly into air tube.
26. Using a small flathead screwdriver, press down on seal head shaft step to seat into place inside air tube. Secure seal head into air tube with retaining ring, using internal snap ring pliers.

IMPORTANT: RETAINING RING MUST BE FULLY SEATED IN UPPER TUBE GROOVE. CHECK RETAINING RING CLOSELY TO ENSURE SECURE FIT.
27. Add air to the positive air chamber (40-60psi) to ensure assembly components are seated properly inside air tube.

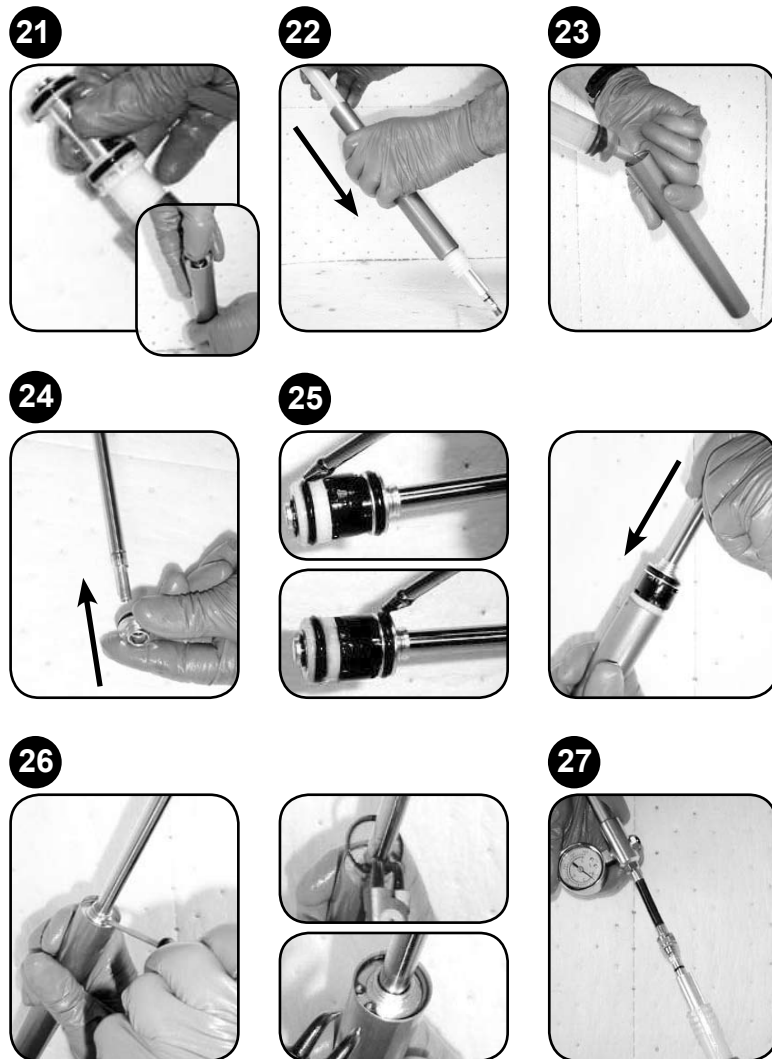

AIR U-TURN SPRING INSTALLATION INSTRUCTIONS (CONT)

28. Insert air tube guide plate into the end of air tube. Secure around small seal head groove with a new 13mm external retaining ring, using external snap ring pliers. Verify retaining ring is seated against guide plate so it cannot move freely.

IMPORTANT: EXTERNAL RETAINING RINGS MAY DEFORM WHEN REMOVED AND INSTALLED. PINCH ENDS TIGHT WITH PLIERS, TO ENSURE CORRECT FIT.

NOTE: THE U-TURN AIR ASSEMBLY IS NOW ASSEMBLED AND READY TO BE INSTALLED INTO FORK UPPER TUBE/CROWN.
29. Place Teflon washer over threaded shaft end, flat against travel shaft. Insert Air U-Turn assembly into bottom of left fork upper tube, adjuster end first.
30. Slide into upper tube until upper assembly engages top cap. Thread assembly into top cap by holding the bottom of the air shaft and turning **COUNTERCLOCKWISE** until it stops.
31. Insert each detent spring into top cap detent holes, evenly spaced. Place each detent ball bearing on top of each detent spring.
32. Place Air U-Turn adjuster knob onto hex shaft end. Secure knob onto air shaft with external retaining ring, using external snap ring pliers. Make sure retaining ring is inserted into groove, not air shaft threads.

IMPORTANT: AIR U-TURN FORK MUST BE SET TO FULL TRAVEL SETTING BEFORE INSTALLING LOWER LEGS. TURN AIR U-TURN KNOB COUNTERCLOCKWISE TO SET TO FULL TRAVEL.

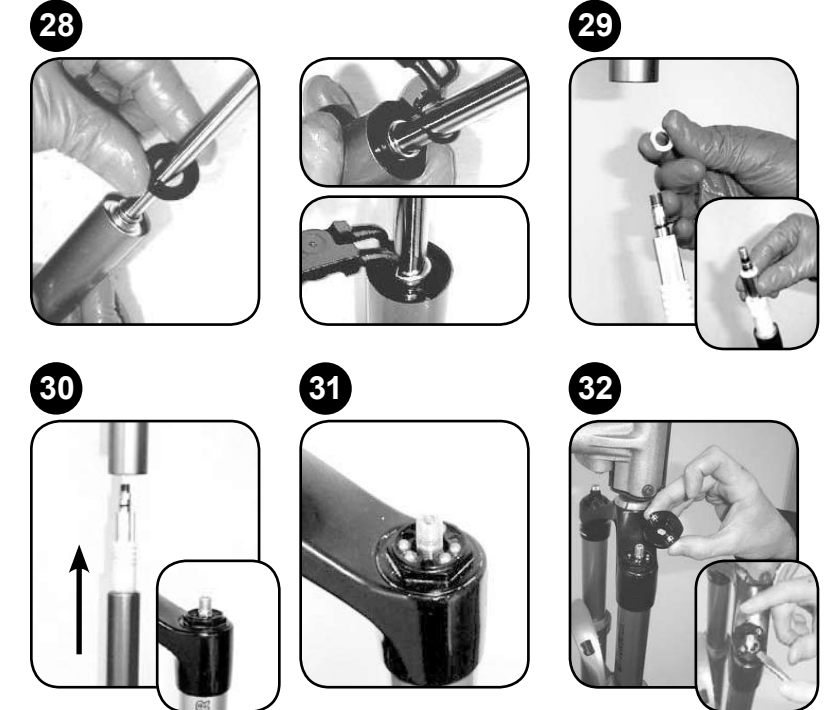

THIS CONCLUDES THE SPRING SERVICE FOR YOUR FORK. YOU DID A GREAT JOB! YOU ARE NOW READY TO MOVE ONTO THE NEXT SECTION, LOWER LEG INSTALLATION. ENJOY!

2-STEP AIR SPRING SERVICE (LYRIK - TOTEM)

INTRODUCTION

At this point you should already have the lowers removed from your fork. If not, you will need to return to the Lower Leg Removal section of this manual and follow the instructions for removing your fork lowers.

2-STEP AIR SPRING REMOVAL/SERVICE INSTRUCTIONS

IMPORTANT: VERIFY ALL AIR PRESSURE IS REMOVED FROM THE AIR CHAMBER BEFORE PROCEEDING. DEPRESS SCHRADER VALVE AGAIN TO REMOVE ANY REMAINING AIR PRESSURE, THEN REMOVE 2-STEP SCHRADER VALVE, LOCATED AT THE BOTTOM OF THE LOWER LEG AIR SHAFT, USING A SCHRADER VALVE TOOL.

1. Remove the 2-Step adjuster fixing screw, using a 2mm hex wrench and remove 2-Step control knob.
2. Unthread and remove the 2-Step top cap, using a 24mm socket wrench. Inspect 2-Step top cap o-ring for damage. Replace if necessary.
3. Remove fork from bicycle stand and pour any remaining oil into oil pan. Return fork to bicycle stand.
4. Remove retaining ring from the bottom of the left upper tube using internal snap ring pliers.
5. Gently pull down on the air shaft to remove the entire 2-Step assembly.
6. Separate the 2-Step assembly into 3 parts: shaft assembly, air tube, and piston housing (in order in picture).
7. Remove piston from the piston housing. Inspect piston housing for damage or scratches, paying close attention the inside surface of the piston housing. If damages or scratched, replace the piston housing.
8. Remove piston o-ring. Clean piston with isopropyl alcohol. Apply a few drops of suspension oil to new o-ring and re-install.
9. Inspect piston housing o-ring for damage. Replace if necessary.
10. Re-assemble piston and piston housing. The piston should be inserted into the housing with the 'hole side' down. Press piston into housing until it bottoms out completely.
NOTE: IMPROPER INSTALLATION OF THE PISTON WILL CHANGE 2-STEP AIR SPRING PERFORMANCE.

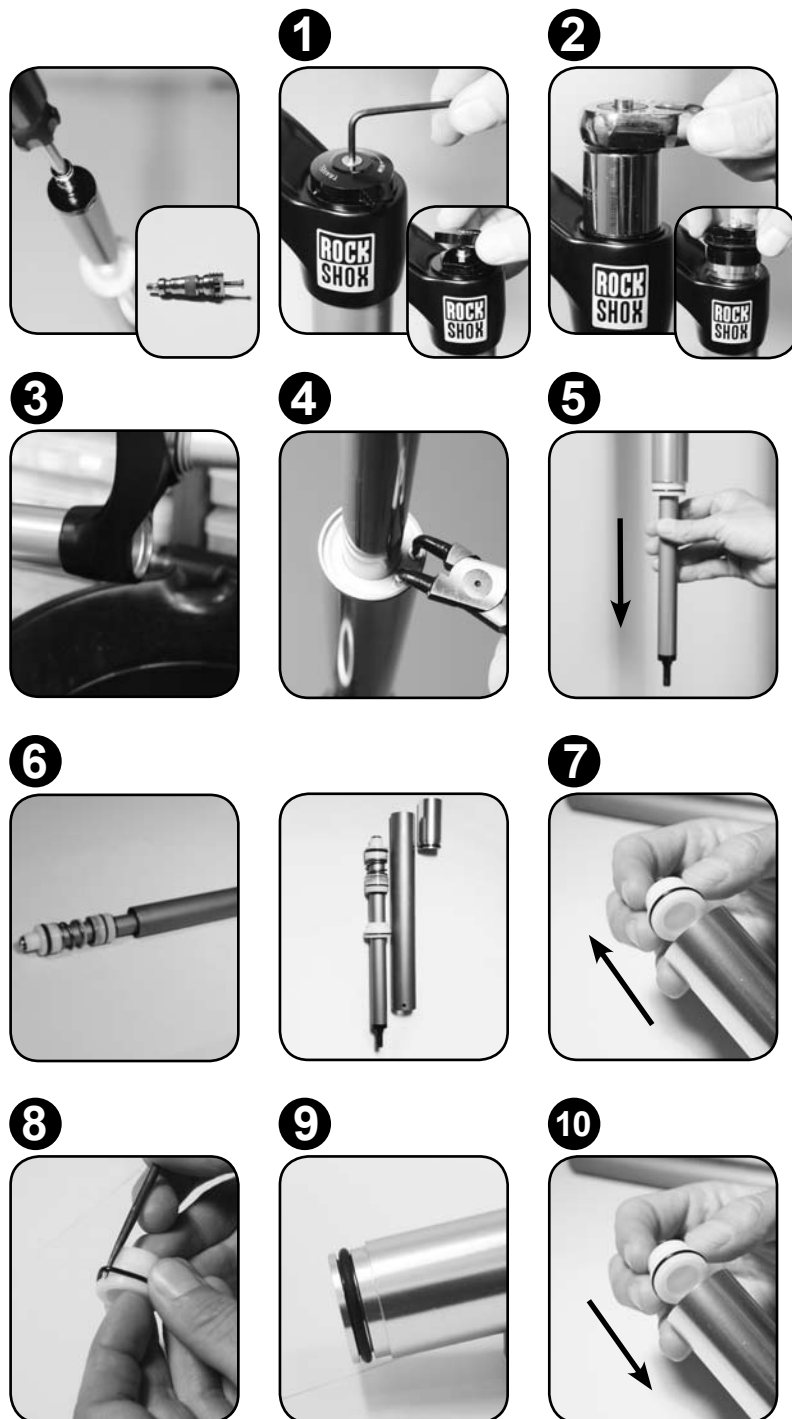

2-STEP AIR SPRING REMOVAL/SERVICE INSTRUCTIONS (CONT)

11. Spray isopropyl alcohol on the inside and outside of the air tube and wipe with a clean rag. Wrap a clean rag around a long dowel and insert into the upper tube to clean inside the upper tube. Inspect the air tube for damage and scratches. Replace if damaged or scratched (not pictured).
12. Remove base plate from shaft assembly. Remove inner and outer base plate o-rings. Apply a few drops of suspension oil to new o-rings and re-install.
IMPORTANT: IF USING A PICK TO REMOVE O-RINGS, DO NOT SCRATCH BASE PLATE OR O-RINGS. SCRATCHES WILL CAUSE PERMANENT AIR LEAK.
13. Remove floating piston from the air shaft assembly. Remove inner and outer floating piston o-rings. Spray floating piston with isopropyl alcohol and wipe with a clean rag. Apply a few drops of suspension oil to new o-rings and re-install.
14. Remove the top out spring from the air shaft and spray with isopropyl alcohol and wipe with a clean rag.
15. Remove the retaining ring located on top of the main piston using external snap ring pliers. Then remove the wavy spring washer.
16. Using a small flathead screwdriver, carefully separate the kick plate and the main piston.
IMPORTANT: DO NOT DAMAGE EITHER THE KICK PLATE OR THE PISTON.
17. Remove the inner and outer piston o-rings. Spray the main piston with isopropyl alcohol and wipe with a clean rag. Apply a few drops of suspension oil to new o-rings and re-install.
18. Spray air shaft with isopropyl alcohol and wipe with a clean rag. Inspect air shaft for damage or scratches. Replace if damaged or scratched (not pictured).

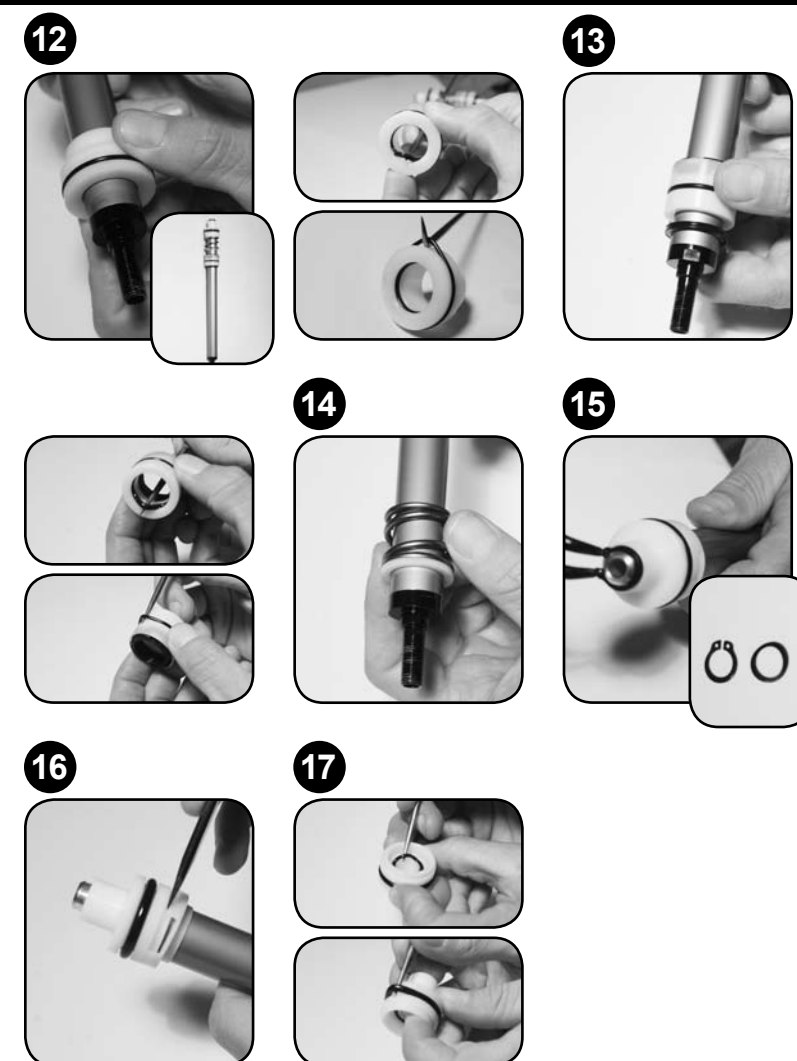

2-STEP AIR SPRING INSTALLATION INSTRUCTIONS

19. Reassemble main piston and kick plate and install onto air shaft. Slide wavy washer on top of main piston and secure into place with snap ring.
20. Install top out spring (spring side first), and floating piston (black quad ring side first) onto air shaft. Do not install base plate at this time.

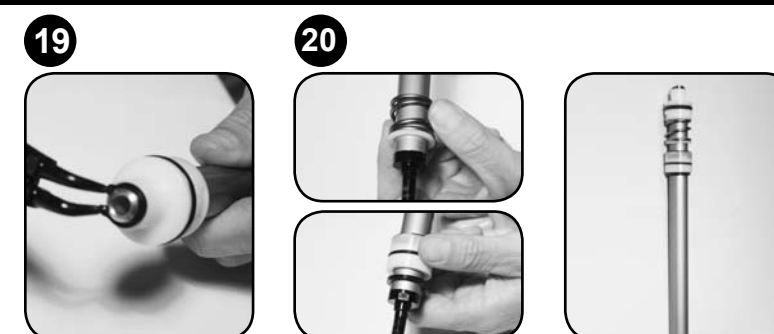

2-STEP AIR SPRING INSTALLATION INSTRUCTIONS (CONT)

21. Install shaft assembly into air tube, air valve first, in the side opposite the two holes on the air tube. Install base plate on shaft assembly.
22. Measure and pour 5cc/ml of 15wt suspension oil into the top of the air tube assembly.
23. Insert the piston housing into the air tube assembly, being careful not to spill the oil.
24. Insert the 2-Step assembly into the bottom of the upper tube. Secure with retaining ring using internal snap ring pliers.

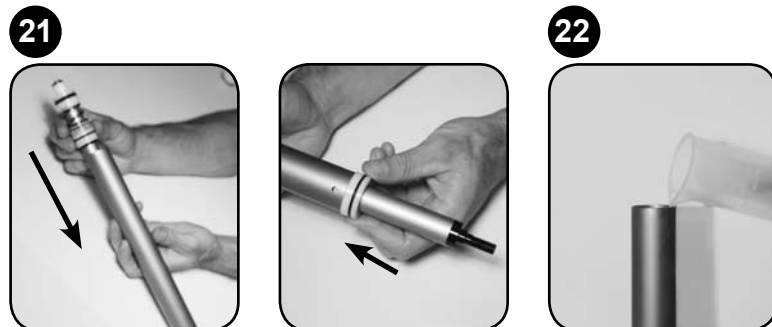

IMPORTANT: RETAINING RING MUST BE FULLY SEATED IN UPPER TUBE GROOVE. CHECK RETAINING RING CLOSELY TO ENSURE SECURE FIT.

25. Gently pull down on air shaft to extend to maximum length.
26. Lyrik Only: Measure and pour 40cc/ml of 2.5wt suspension oil into the top of the upper tube.
Totem Only: Measure and pour 135cc/ml of 2.5wt suspension oil into the top of the upper tube.

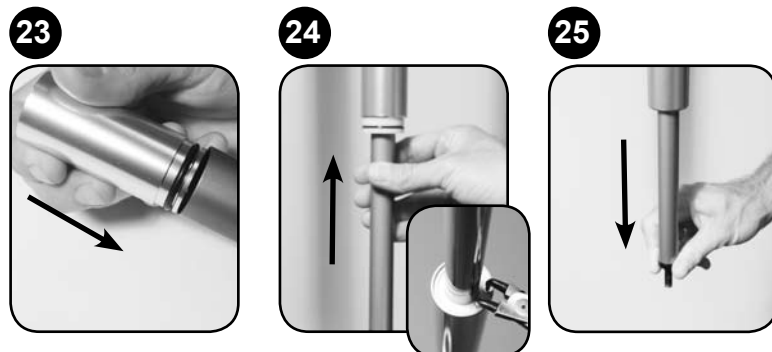

NOTE: THE OIL WILL JUST REACH THE BOTTOM OF THE UPPER TUBE THREADS.

27. Insert top cap into upper tube/crown and hand thread into upper tube. Using a 24mm socket wrench, tighten to 60 in-lb.
28. Install 2-Step adjuster knob and secure fixing screw with a 2mm hex wrench.
29. Install schrader valve into bottom of air shaft, using schrader valve tool.
30. Add 50psi to the 2-Step system. Rotate adjuster knob to minimum travel position and compress air shaft to ensure proper function. Rotate adjuster knob to full travel position and verify return to full extension.

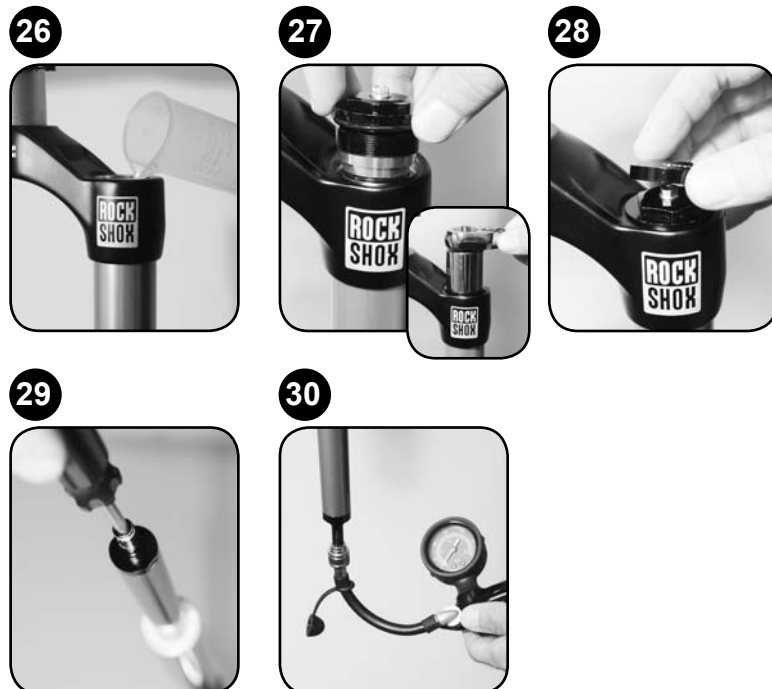

THIS CONCLUDES THE SPRING SERVICE FOR YOUR FORK. YOU DID A GREAT JOB! YOU ARE NOW READY TO MOVE ON TO THE NEXT SECTION, LOWER LEG INSTALLATION. ENJOY!

LOWER LEG INSTALLATION



LOWER LEG INSTALLATION (ALL FORKS)

INTRODUCTION

At this point you should already have already serviced your fork bushings, damper system, and spring system. Once you have re-installed your fork lowers, you will have successfully serviced your fork and you will be ready to ride!

LOWER LEG INSTALLATION INSTRUCTIONS

1. Spray upper tubes with isopropyl alcohol and wipe with a clean rag (not pictured).
2. Pour or inject 15wt suspension oil onto new or clean foam rings, just under dust seals inside each lower leg.
3. Slide lower leg assembly on the upper tubes until you feel the lower bushing touch the end of the upper tubes.

IMPORTANT: MAKE SURE BOTH DUST SEALS SLIDE ONTO THE TUBES CORRECTLY AND DO NOT FOLD UNDER.

4. Invert fork to about 45°, fork legs pointing upward. Measure and inject suspension oil into lower legs through each shaft bolt hole, according the bottom volume values found in the Oil Volume chart located in the Getting Started Information section of this manual. Wipe all excess oil from lower legs.

NOTE: boXXer ONLY - SLIDE DAMPER SIDE FORK LEG BACK ONTO UPPER TUBE UNTIL THE LOWER BUSHING TOUCHES THE END OF THE UPPER TUBE AFTER INJECTING OIL.

4. Inspect and clean air spring shaft bolts, black nylon crush washers and crush wash retainers. Replace crush washers and crush washer retainers if damaged (not pictured).

NOTE: DAMAGED OR DIRTY CRUSH WASHERS CAN CAUSE OIL TO LEAK.

6. Insert rebound damper and air spring shaft bolts into threaded shaft ends, through lower leg shaft holes and tighten with a 5mm hex or 10mm socket wrench to 60in-lb.

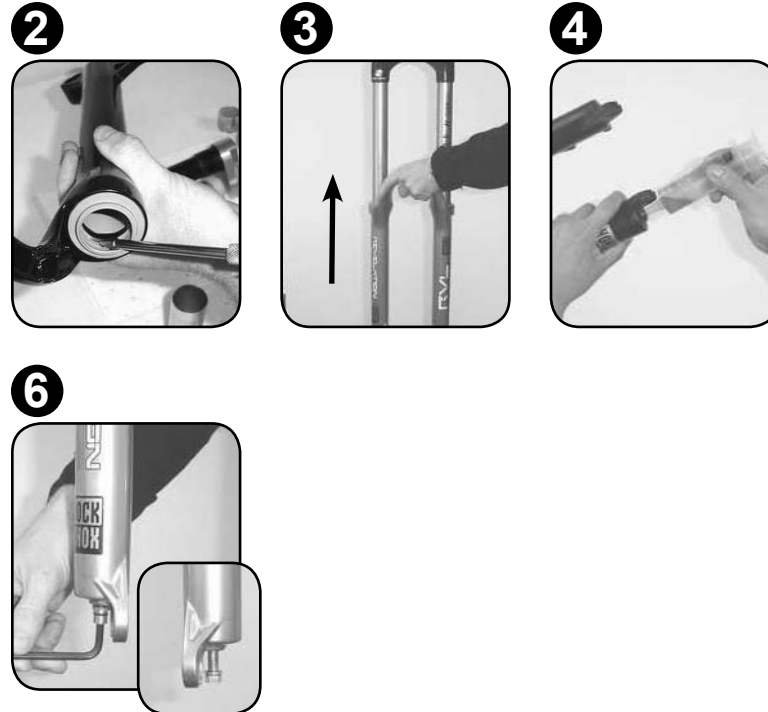

LOWER LEG INSTALLATION INSTRUCTIONS (CONT)

NOTE: boXXer ONLY - INSERT EACH UPPER TUBE EVENLY INTO THE LOWER CROWN. PULL UPPER TUBES UP AND INTO THE CROWN, TWISTING GENTLY AS THE UPPER TUBES EASE INTO THE HOLES. PULL LEFT (DAMPER SIDE) UPPER TUBE UP TO THE FULLY EXTENDED POSITION (DO NOT OVER EXTEND!).

MEASURE 205MM FROM THE DUST/LOWER LEG TO THE BOTTOM OF THE LOWER CROWN HOLE AND TIGHTEN THE CROWN BOLT WITH A 4MM HEX TO 65 IN/LB. PULL THE RIGHT (SPRING SIDE) UPPER TUBE EVEN WITH THE LEFT AND TIGHTEN THE CROWN BOLT TO 65 IN/LB. MAKE SURE THE UPPER TUBES ARE POSITIONED AT AN EVEN HEIGHT! REFER TO THE DIAGRAM FOR CROWN MEASUREMENTS. SLIDE EACH UPPER TUBE/FRAME BUMPER ONTO EACH UPPER TUBE. INSTALL UPPER CROWN ONTO UPPER TUBES AND STEERER TUBE. REFER TO THE DIAGRAM FOR APPROPRIATE MEASUREMENTS. TIGHTEN UPPER CROWN WITH A 4MM HEX WRENCH TO 65 IN-LB.

7. Insert external rebound damper knob into rebound damper shaft bolt. Push in until secure. Adjust as desired.
8. For air spring forks, refer to the air chart on your fork and inflate positive and negative air chambers to appropriate psi. For coil forks, move onto Step 9.
9. Spray isopropyl alcohol onto entire fork and wipe with a clean rag (not pictured).
10. Thread positive and negative air valve cap covers onto air top cap.

THIS CONCLUDES THE SERVICE FOR YOUR FORK. YOU DID A GREAT JOB! YOU ARE NOW READY TO INSTALL YOUR FORK ON YOUR BIKE AND GO FOR A RIDE!

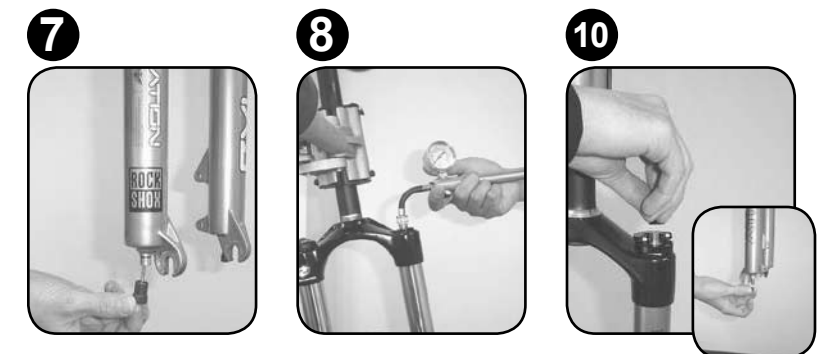
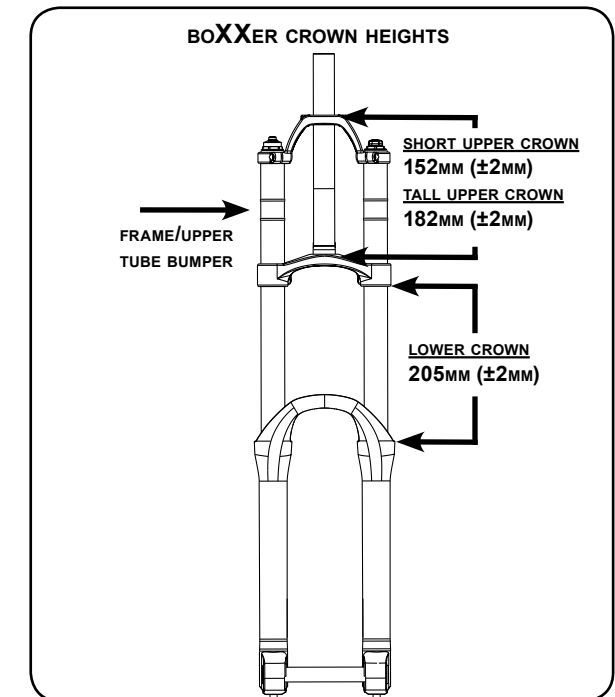
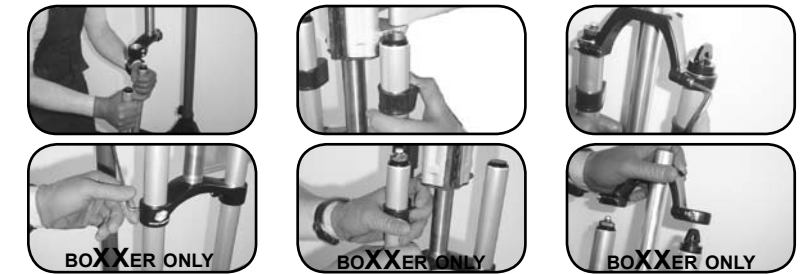

REAR SHOCK SERVICE



REAR SHOCK SERVICE

(ALL SHOCKS)

INTRODUCTION

Prior to servicing your rear shock, you will first need to remove it from your bicycle frame.

AIR CAN REMOVAL/SERVICE INSTRUCTIONS

1. Spray isopropyl alcohol on entire shock and wipe with a clean rag (not pictured).
2. Using your fingers or pliers, remove all shock eyelet mounting hardware.
3. Remove air valve cover cap. Using a small hex wrench or pick, depress schrader valve and release all air from shock

IMPORTANT: TO AVOID INJURY, ALL AIR PRESSURE MUST BE RELEASED FROM SHOCK PRIOR TO REMOVING THE AIR CAN.

4. Gently secure air can shock eyelet into bench vice.

NOTE: USE ALUMINUM VICE "SOFT-JAWS" TO PROTECT THE SHOCK EYELET WHEN CLAMPED.

5. Grip the air can by hand and turn firmly counterclockwise. Pull the air can up shock damper body slowly to remove.

NOTE: AIR PRESSURE MAY RELEASE, SO HOLD AIR CAN TIGHTLY WHILE PULLING UP.

6. Remove negative spring spacer and negative spring bumper. Spray both with isopropyl alcohol and wipe with a clean rag.

IMPORTANT: DO NOT ATTEMPT TO DISASSEMBLE SHOCK DAMPER AND/OR SHOCK EYELET ASSEMBLY. THEY ARE NOT SERVICEABLE.

7. Using a sharp pick, remove the black rubber dust seal from the air can.

8. Hold air can, narrow end down and remove blue air can glide ring with a sharp pick.

IMPORTANT: DO NOT SCRATCH THE INSIDE OF THE AIR CAN WITH PICK. SCRATCHES CAN CAUSE PERMANENT AIR BYPASS.

9. Spray isopropyl alcohol inside air can and wipe with a clean rag. Inspect the inside of the air can for any rough surfaces or scratches. Run your finger along the inside surface of the air can to feel for rough surfaces or scratches as well. Replace air can if scratched or damaged (not pictured).

10. Remove large fixed air piston o-ring. Apply a few drops of suspension oil to new o-ring and re-install.

IMPORTANT: THE FIXED AIR PISTON O-RING IS THE MAIN AIR SEAL. BE SURE TO REPLACE THIS O-RING.

2



3



4



5



6



6



7

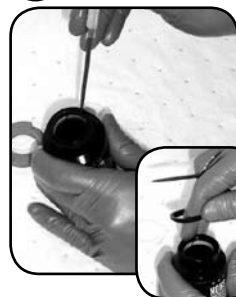

8



10



AIR CAN REMOVAL/SERVICE INSTRUCTIONS

11. Install new air can glide ring and new air can dust seal.
12. Spray isopropyl alcohol on air can threads and eyelet body threads and wipe with a clean rag (not pictured).
13. Apply 2-3 drops of blue threadlock to eyelet body threads, evenly spaced. Spread evenly onto threads and wipe away excess threadlock with a clean rag.
14. Apply a small amount of 5wt suspension oil to the inside of the air can. Using your finger, spread and coat the entire inner air can surface with the oil. Re-apply a few drops of suspension oil to the glide ring and rubber dust seal.

IMPORTANT: COATING THE INSIDE THE AIR CAN WITH SUSPENSION OIL ENSURES LUBRICATION OF THE FIXED AIR PISTON O-RING, WHICH REDUCES FRICTION AND O-RING WEAR.

15. Install negative spring bumper and negative spring spacer.
16. Position air can over shock eyelet and slide down on shock body. Press air can down firmly and thread clockwise to tighten into eyelet body as tightly as possible by hand. **NOTE: ENSURE THE OUTSIDE OF THE AIR CAN IS FREE FROM OIL. THIS ALLOWS MORE LEVERAGE WHEN TIGHTENING AIR CAN ONTO SHOCK EYELET BODY.**
17. Using a shock pump, inflate shock to desired air pressure and install valve cover cap (not pictured).
18. Spray isopropyl alcohol on entire shock and wipe with a clean rag (not pictured).
19. Insert mounting hardware into both eyelets (not pictured).

THIS CONCLUDES THE SPRING SERVICE FOR YOUR SHOCK. YOU DID A GREAT JOB! YOU ARE NOW READY TO RE-INSTALL YOUR SHOCK ONTO YOUR BIKE AND GO FOR A RIDE!

11



12



13



14



15

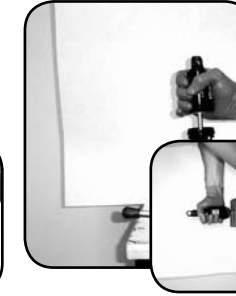

www.sram.com
www.rockshox.com

WORLD HEADQUARTERS
SRAM Corporation
1333 N. Kingsbury St., 4th Floor
Chicago, IL 60622
phone: +1-312-664-8800
fax: +1-312-664-8826

EUROPEAN HEADQUARTERS
SRAM Europe
Basicweg 12-D
3821 BR Amersfoort
The Netherlands
phone: +31-33-450-6060
fax: +31-33-457-0200

ASIAN HEADQUARTERS
SRAM Taiwan
No. 1598-8 Chung Shan Rd
Shen Kang Hsiang, Taichng
County 49
Taiwan R.O.C.
phone: +886-4-2561-3678
fax: +886-4-2561-3686



.....**POWERED BY SRAM™**