

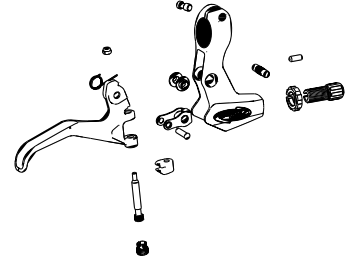

# 2007 AVID TECHNICAL MANUAL

(ENGLISH)  
Part# 95-5015-004-000

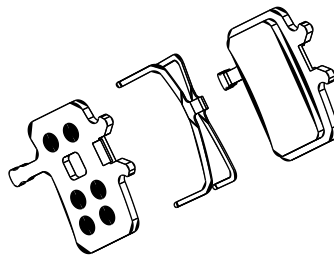
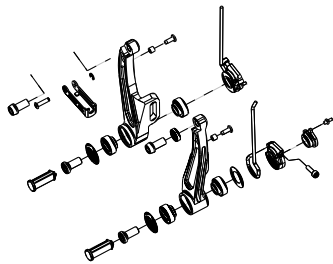
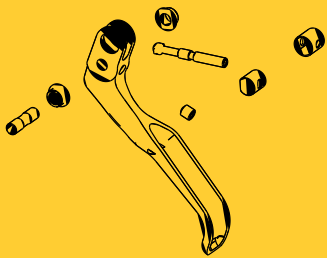

# TABLE OF CONTENTS

<b>Getting Started Information</b> .....	5
Brake Technology Designation.....	6
Tools Needed for Service.....	7
<b>Hydraulic Disc Brake Lever Overhaul</b> .....	9
Juicy 3, 5, 7, Carbon, Ultimate.....	10
CODE.....	16
<b>Disc Brake Caliper Overhaul</b> .....	21
Juicy 3, 5, 7, Carbon.....	22
Juicy Ultimate.....	25
CODE.....	29
BB7.....	33
<b>Hydraulic Disc Brake Hose Length Adjustment &amp; Bleeding</b> .....	39
Juicy 3, 5, 7, Ultimate, Carbon - CODE.....	40
<b>Disc Brake Pad Change</b> .....	45
Juicy 3, 5, 7, Carbon, Ultimate.....	46
CODE.....	47
BB7.....	48



# SAFETY FIRST!

At SRAM Corporation, we care about YOU, our customer. Please, **ALWAYS** wear your safety glasses when servicing your Avid brakes. There are just too many trails to ride, vistas to summit and sunrises to see. **Protect your eyes! Wear your safety glasses!**

## GETTING STARTED INFORMATION



The 2007 Avid Technical Manual was created to help you tune, service, and troubleshoot your Avid products. For exploded diagrams and part number information, please refer to the Avid Spare Parts Catalog available on our website at [www.sram.com](http://www.sram.com) or [www.avidbike.com](http://www.avidbike.com).

For ordering information, please contact your local distributor or visit our website.

Information contained in this publication is subject to change at anytime without prior notice. For the latest technical information, please visit our website. Product names used in this manual may be trademarks or registered trademarks of others.

© SRAM CORPORATION • 2007 AVID TECHNICAL MANUAL

## BRAKE TECHNOLOGY DESIGNATION (ALL BRAKES)

The following chart is a complete list of the 2007 Avid brake line-up. It details the brake model and corresponding technologies of each brake. It is important to determine the technology used in your brake in order to successfully service it, as this manual is sectioned by technology, rather than brake models. If you are unsure of the technology of your brakes, consult your local Avid dealer for assistance. This manual assumes you are performing a complete overhaul of the entire braking system: levers, calipers, pad replacement and performing a bleed (hydraulic disc brakes only).

**IMPORTANT: YOU MUST BLEED YOUR BRAKES** if you overhaul the levers and/or the calipers on a hydraulic disc brake system. Overhauling the levers and/or calipers introduces small amounts of air into the system. Failure to bleed the brakes to remove this air can degrade the performance of your brakes, which could lead to serious and/or fatal injury while riding.

BRAKE MODEL	HYDRAULIC DISC	MECHANICAL DISC	HOSE ADJUST & BLEED	PAD REPLACEMENT
JUICY 3	X		X	X
JUICY 5	X		X	X
JUICY 7	X		X	X
JUICY CARBON	X		X	X
JUICY ULTIMATE	X		X	X
CODE	X		X	X
BB7 (Mountain and Road)		X		X

## TOOLS NEEDED FOR SERVICE (ALL BRAKES)

The following chart is a list of the tools needed to service on your 2007 model year Avid brakes. While this chart is intended to be comprehensive, it is still only a guide. The tools required for each step of service are detailed in the text of each service section. Keep in mind your specific brakes may not require every tool listed.

TOOLS	LEVER OVERHAUL	CALIPER OVERHAUL	HOSE ADJUST & BLEED	PAD REPLACEMENT
<b>SAFETY/STARTING EQUIPMENT</b>				
SAFETY GLASSES	X	X	X	X
APRON	X	X	X	X
RUBBER GLOVES	X	X	X	X
CLEAN RAGS (LINT FREE)	X	X	X	X
OIL PAN	X	X	X	X
CLEAN WORK AREA	X	X	X	X
<b>WRENCHES/PLIERS</b>				
2.5MM HEX	X		X	
4MM HEX		X	X	X
T-10 TORX	X	X		
8MM OPEN END OR BOX WRENCH		X		
11MM BOX WRENCH		X		
TORQUE WRENCH			X	
NEEDLE-NOSED PLIERS	X	X		X
SNAP RING PLIERS - INTERNAL	X	X		
E-CLIP TOOL (OPTIONAL)	X			
<b>MISC TOOLS/KITS</b>				
AVID BLEED KIT	X	X	X	
HYDRAULIC LINE CUTTERS OR VERY SHARP HOUSING CUTTERS			X	
SHARP PICK	X	X	X	
ISOPROPYL ALCOHOL			X	
SMALL AND LARGE FLATHEAD SCREWDRIVERS	X	X		X
AIR COMPRESSOR WITH BLOW GUN CHUCK		X		
SOAPY WATER	X	X	X	
ICE COLD BEVERAGE	X	X	X	X

# HYDRAULIC DISC BRAKE LEVER OVERHAUL



# HYDRAULIC DISC BRAKE LEVER OVERHAUL

(JUICY 3, 5, 7, CARBON, ULTIMATE)

## INTRODUCTION

Avid brake lever assemblies need to be serviced in order to optimize braking function. If brake fluid is leaking from any area of the brake lever assembly, there may be damage or wear-n-tear to the internal moving parts. If your brake was filled with fluid OTHER than DOT 4 or 5.1, damage to all rubber and plastic internal parts may exist. If your brake was damaged in a crash, there may be damage to the lever blade and pushrod assemblies, as well as the reservoir cap, bladder and star wheel assemblies. Inspection and/or replacement of these parts, due to any of the above situations, will improve brake function.

## LEVER OVERHAUL SERVICE INSTRUCTIONS

### GETTING STARTED

1. Remove brake lever from handlebar. Remove caliper from fork or frame. If dirty, clean with soapy water and a clean rag. Pull hose boot off compression nut and slide down hose (not pictured).
2. Using an 8mm crow's-foot (included in Avid Bleed Kit) and socket wrench (or use a flare nut 8mm wrench), loosen and remove compression nut from lever body. Turn counter-clockwise to remove. Unthread completely by hand and slide compression nut down hose. Pull brake hose and compression fitting from lever body.
3. Allow any brake fluid to drain into a container. Hold lever assembly over container and pump lever to remove any brake fluid inside lever assembly.

**NOTE: IF THE SYSTEM HAS BEEN CONTAMINATED WITH THE WRONG FLUID, YOU WILL NEED TO FLUSH ALL THE PARTS WITH SOAPY WATER AND ALLOW TO DRY FULLY PRIOR TO REBUILDING. YOU WILL ALSO NEED TO INSTALL A NEW HOSE.**

### RESERVOIR COVER/BLADDER REMOVAL

4. Using a small Phillips screwdriver, remove both reservoir cover screws.
5. Remove reservoir cover cap and bladder from lever assembly. Additional brake fluid will drain from lever. Hold lever over container and allow fluid to drain. Set lever assembly down on clean towel (not pictured).
6. Holding the reservoir cover, remove bladder from reservoir cover. Replace with new bladder if contaminated and leaking fluid.

**NOTE: POSSIBLE CAUSES OF LEAKING BLADDER AND/OR RESERVOIR INCLUDE: BRAKE SYSTEM MAY HAVE TOO MUCH FLUID, BLADDER MAY HAVE SPLIT, AND/OR BLADDER MAY BE CONTAMINATED.**

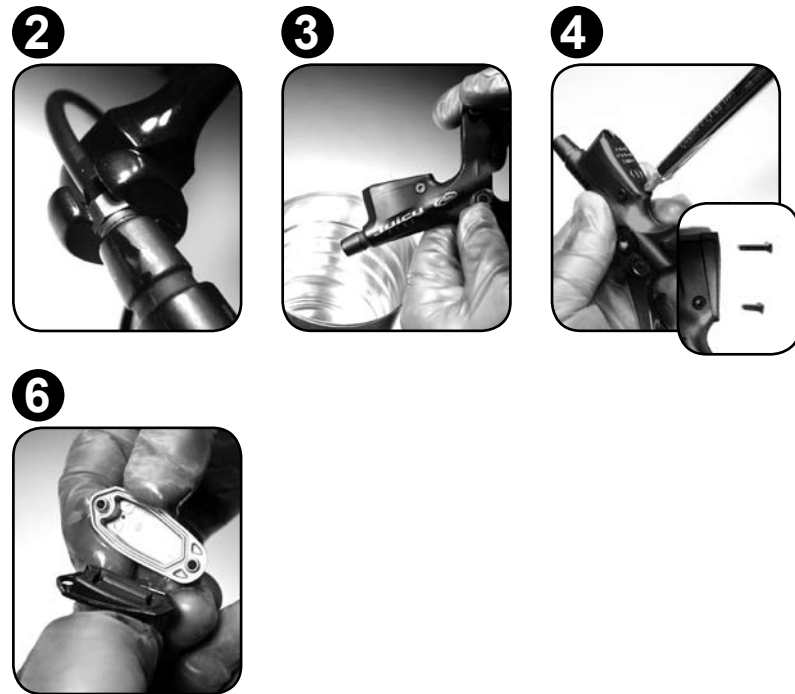

## LEVER OVERHAUL SERVICE INSTRUCTIONS (CONT)

### RESERVOIR COVER/BLADDER INSTALLATION

7. Insert new bladder into cover and seat flush into underside of reservoir cover. Make sure you have the correct orientation.
8. Place reservoir cover and bladder back onto lever body. Install and tighten cover cap screws (short screw closest to lever clamp). Tighten both screws with a Phillips screwdriver.

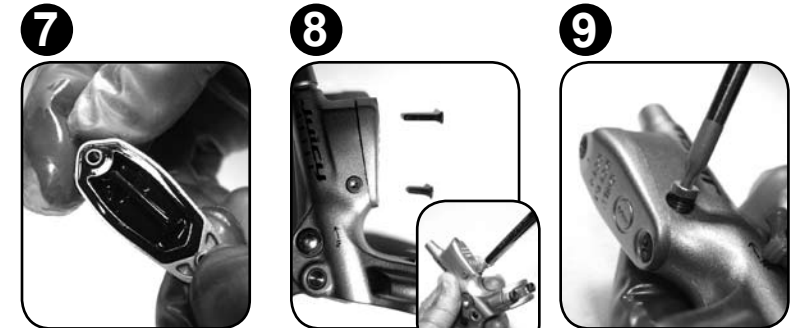

### BLEED SCREWS REMOVAL

9. Use a T-10 Torx wrench to remove both bleed screws.
10. Using a sharp pick, remove both o-rings on bleed screws and replace.
11. Install bleed screws back into lever body. **NOTE: FOR JUICY 3, 5 PLEASE MOVE ONTO THE LEVER BLADE/PUSHROD REMOVAL PROCEDURES.**



### STAR WHEEL AND WORM REMOVAL - JUICY 7, CARBON, & ULTIMATE ONLY

12. Remove retaining e-clip with sharp pick or small flathead screwdriver.
13. Juicy 7, Carbon Only: Unthread star wheel and worm from lever body. Unthread by hand; pull out to remove from lever assembly. **OR** Juicy Ultimate Only: Unthread worm from lever body using a 2.5mm hex.
14. Using a pick, insert into gear hole, and push bushing out of lever body. Set star wheel/worm assembly aside.

**NOTE: DO NOT RE-INSTALL STAR WHEEL AND WORM GEAR BACK INTO LEVER ASSEMBLY AT THIS POINT. IMPORTANT: REPLACE THE STAR WHEEL AND WORM GEAR IF IT IS DAMAGED, CRACKED OR BROKEN, OR IF YOU ARE SWITCHING SIDES OF LEVER BODY OR ROTATING BRAKE LEVER TO OTHER SIDE OF BAR.**

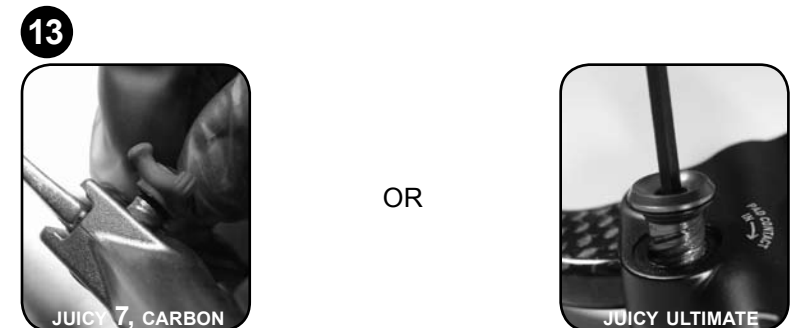

### LEVER BLADE/PUSHROD REMOVAL

15. Juicy 5, 7, Carbon, Ultimate Only: Holding the lever in both hands, place your thumbs near the pivot and push. The lever gently snaps into the open position.
16. Use a 2.5mm hex wrench and unthread lever pivot set screw and remove completely.
17. Using a sharp pick, or small hex wrench, push lever pivot pin through lever body and remove.

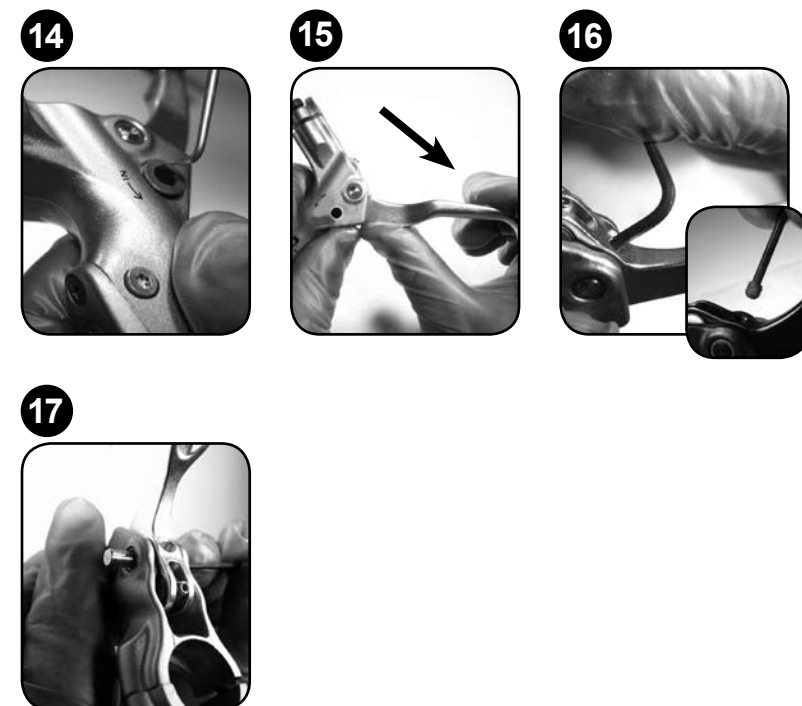

## LEVER OVERHAUL SERVICE INSTRUCTIONS (CONT)

### LEVER BLADE/PUSHROD REMOVAL (CONT)

18. Juicy 3 Only: Use a 2mm hex wrench and unthread the lever pushrod screw completely, by turning counterclockwise. Pull lever blade away from lever body.

OR

Juicy 5, 7, Carbon, Ultimate Only: Pull lever blade away from lever body and remove pushrod pin from worm gear. It will pop out. Remove pushrod from lever. Replace pushrod dust boot if damaged. Clean if not damaged. Insert pushrod dust boot back onto pushrod with the open end facing the pin and the closed end toward threads. Re-install pushrod into lever blade. Pushrod unthreads and threads back into lever blade (not pictured).

**IMPORTANT: REPLACE LEVER BLADE AND/OR PUSHROD IF EITHER IS BENT OR DAMAGED.**

### INTERNALS REMOVAL

Take a few moments and familiarize yourself with the internal components of your brake lever. This will assist you in identifying the components while you service your brake.

18



JUICY 3

OR



JUICY 5,  
CARBON, ULTIMATE

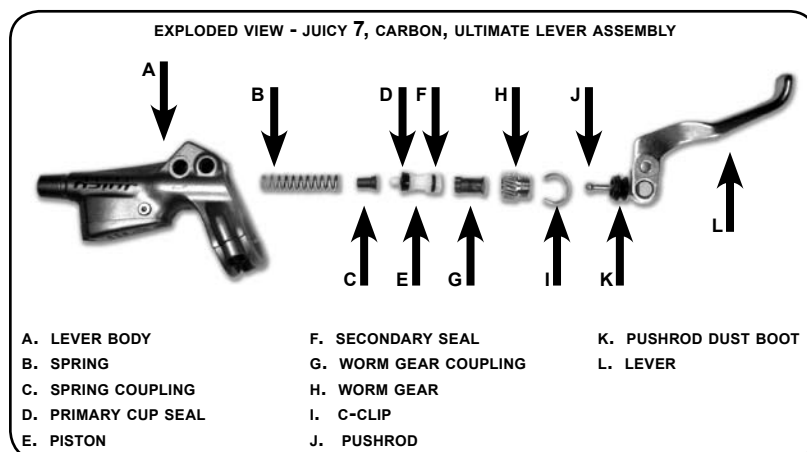
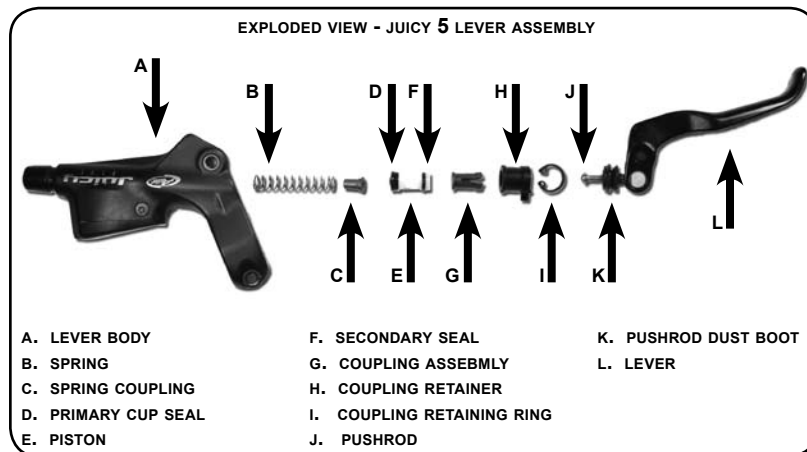
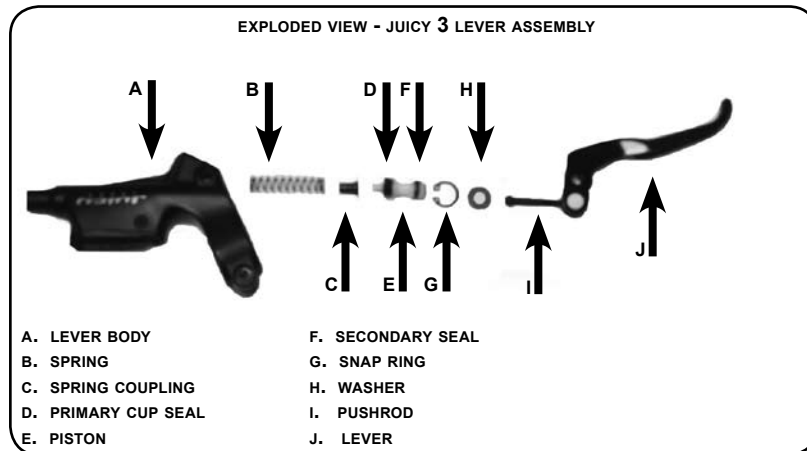

## LEVER OVERHAUL SERVICE INSTRUCTIONS (CONT)

### INTERNALS REMOVAL

19. Juicy 3, 5 Only: Using straight internal snap ring pliers, remove coupling retaining ring. Pull retaining ring from inside the lever body. **IMPORTANT: PULL RETAINING RING OUT SLOWLY. THE COUPLING RETAINER/COUPLING ASSEMBLY MAY 'POP' OUT WITH THE FORCE OF THE SPRINGS. DO NOT LOOK INSIDE WHILE REMOVING TO AVOID POTENTIAL EYE DAMAGE.**

Using needle-nosed pliers, carefully remove coupling retainer/coupling assembly. Coupling retainer should slide out from lever body easily.

Hold lever body assembly upside down and drop the piston/spring assembly into your hand. It should slide out easily.

OR

Juicy 7, Carbon, Ultimate Only: Rotate worm gear retaining clip with a small flat-head screwdriver or sharp pick until the end of the clip protrudes past the gap in the lever body (push end of clip to rotate within groove).

Using needle-nosed pliers, grasp the clip to remove from the lever body. Insert a large flathead screwdriver into wide slot in top of worm gear and turn counterclockwise. Unthread worm gear completely and slide/pull worm gear out of lever body assembly. Worm gear coupling is located inside worm gear.

The piston spring (below piston inside lever body) should force piston assembly out of lever body. If the spring does not aid piston removal, use a sharp hooked pick to pull piston and spring assembly from lever body. Be careful not to damage the piston.

**NOTE: IF THE WORM GEAR COUPLING IS CRACKED, PULL COUPLING OUT OF GEAR AND REPLACE. COUPLING CAN WEAR OUT OVER TIME AND CRACK.**

20. With piston/spring assembly removed from lever body, remove the piston from the spring.

21. Using a small flathead screwdriver, remove spring coupling from piston. Do not scratch any plastic parts (piston or o-rings). If damaged, you will need to replace the piston.

22. Slide piston coupling out of piston (not pictured).

23. Remove and replace piston secondary seal (small o-ring) on top of piston.

19



JUICY 3, 5



JUICY 3, 5



JUICY 3, 5

OR



JUICY 7, CARBON  
ULTIMATE



JUICY 7, CARBON  
ULTIMATE



JUICY 7, CARBON  
ULTIMATE

20



JUICY 7, CARBON  
ULTIMATE



21



23



## LEVER OVERHAUL SERVICE INSTRUCTIONS (CONT)

### INTERNALS REMOVAL (CONT)

24. Remove primary cup seal (lower large black seal) from piston with sharp pick and slide new coupling seal onto base of piston. Ensure it sits flush (flat end first, flush against piston, open end out).
25. Re-install spring coupling back onto piston and coupling seal (into open end of seal).
26. Re-install spring onto coupling. The coupling lightly snaps onto piston.

24



25



26



### INTERNALS INSTALLATION

27. Insert spring/piston assembly back into lever body, spring first.
28. Juicy 5 Only: Insert coupling retainer and coupling assembly onto top of piston, inside lever body. The v-shape of the retainer should be positioned in the lever blade groove. Using straight internal snap ring pliers, insert coupling retaining ring above coupling retainer and into groove in lever body. Ensure retaining ring snaps into place securely.

27



28



OR

Juicy 7, Carbon, Ultimate Only: Slide worm gear coupling (geared end first) into narrow end of worm gear. The coupling slides directly into inner worm gear threads. Insert worm gear and coupling assembly onto top of piston, inside lever body. Insert large flathead screwdriver into open end (flat slot) of worm gear. Turn clockwise to thread worm gear into lever body. Press down into worm gear while the gear threads into lever body. You will feel spring resistance as you turn. Worm gear threads will engage the threads in lever body. Turn clockwise until worm gear is completely inside lever body, then back off three turns. This is the correct installation setting. Using needle-nosed pliers, insert worm gear retaining clip above worm gear. Position one end of clip into groove and slowly but firmly push down on clip with pliers until clip snaps firmly into place in groove. Rotate clip until ends are inside of groove.



OR



**NOTE: ENDS OF CLIP MUST NOT PROTRUDE PAST LEVER BODY GROOVE OR EXTEND INTO LEVER SLOT/GAP IN LEVER BODY.**



## LEVER OVERHAUL SERVICE INSTRUCTIONS (CONT)

### LEVER/PUSHROD INSTALLATION

29. Juicy 3 Only: Line up the pushrod with the pushrod pin on the lever body. Use a 2mm hex wrench and thread the lever pushrod screw completely, by turning clockwise.
  - OR
  - Juicy 5 Only: Line up pushrod pin with slot in coupling retainer. Insert pushrod pin into coupling retainer. Pushrod pin snaps into slot.
  - OR
  - Juicy 7, Carbon, Ultimate Only: Line up pushrod pin with slot in worm gear coupling (wide slot in center of worm gear coupling). Insert pushrod into worm gear coupling. Pushrod pin snaps into worm gear inner coupling slot.
  32. Insert lever bushings into lever body; one on each side. The bushing lip (larger end) should be on inside of lever body.
  33. Line up lever pivot pin hole with bushing holes. Insert pivot pin back into lever and bushings. Use your thumb to press down on pivot pin and snap it into place.
  34. Install the pivot pin set screw into the lever blade and tight with a 2.5mm hex wrench.
- NOTE: THIS CONCLUDES THE LEVER OVERHAUL SERVICE INSTRUCTIONS FOR JUICY 3, 5. PLEASE MOVE ONTO STEP 37, FINISHING UP PROCEDURES.**

29



OR



### STAR WHEEL AND WORM INSTALLATION - JUICY 7, CARBON, ULTIMATE ONLY.

- NOTE: JUICY ULTIMATE IS NOT EQUIPPED WITH A STAR WHEEL KNOB, HOWEVER, THE PROCEDURE IS SIMILAR.**
35. Juicy 7, Carbon Only: Press star wheel/worm bushing back into lever body with thumb. Thread star wheel/worm assembly back into lever body.
  - OR
  - Juicy Ultimate Only: Press bushing back into lever body with thumb. Using a 2.5mm hex, thread onto worm.
  36. Using a pair of needle-nosed pliers or a retaining clip tool, press the retaining clip onto end of worm to secure lever assembly.

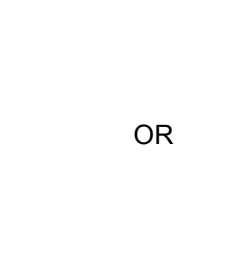

OR

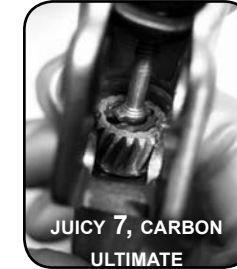

32



33



34



35



OR



36



### FINISHING UP

37. Clean the entire lever assembly with soapy water and clean rag (not pictured).

**THIS CONCLUDES THE LEVER OVERHAUL SERVICE INSTRUCTIONS. YOU HAVE DONE A GREAT JOB AND ARE READY TO MOVE ONTO THE NEXT CHAPTER, HYDRAULIC DISC BRAKE CALIPER OVERHAUL. ENJOY!**



# HYDRAULIC DISC BRAKE LEVER OVERHAUL (CODE)

## INTRODUCTION

Avid brake lever assemblies need to be serviced in order to optimize braking function. If brake fluid is leaking from any area of the brake lever assembly, there may be damage or wear-n-tear to the internal moving parts. If your brake was filled with fluid OTHER than DOT 4 or 5.1, damage to all rubber and plastic internal parts may exist. If your brake was damaged in a crash, there may be damage to the lever blade and pushrod assemblies, as well as the reservoir cap, bladder and star wheel assemblies. Inspection and/or replacement of these parts, due to any of the above situations, will improve brake function.

## LEVER OVERHAUL SERVICE INSTRUCTIONS

### GETTING STARTED

1. Remove brake lever from handlebar. Remove caliper from fork or frame. If dirty, clean with soapy water and a clean rag. Pull hose boot off compression nut and slide down hose (not pictured).
2. Using an 8mm crow's-foot (included in Avid Bleed Kit) and socket wrench (or use a flare nut 8mm wrench), loosen and remove compression nut from lever body. Turn counter-clockwise to remove. Unthread completely by hand and slide compression nut down hose. Pull brake hose and compression fitting from lever body.
3. Allow any brake fluid to drain into a container. Hold lever assembly over container and pump lever to remove any brake fluid inside lever assembly.

**NOTE: IF THE SYSTEM HAS BEEN CONTAMINATED WITH THE WRONG FLUID, YOU WILL NEED TO FLUSH ALL THE PARTS WITH SOAPY WATER AND ALLOW TO DRY FULLY PRIOR TO REBUILDING. YOU WILL ALSO NEED TO INSTALL A NEW HOSE.**

### RESERVOIR COVER/BLADDER REMOVAL

4. Using a T-10 Torx wrench, remove the reservoir cover screws.
5. Remove reservoir cover cap and bladder from lever assembly. Additional brake fluid will drain from lever. Hold lever over container and allow fluid to drain. Set lever assembly down on clean towel (not pictured).
6. Holding the reservoir cover, remove bladder from reservoir cover. Replace with new bladder if contaminated and leaking fluid.

**NOTE: POSSIBLE CAUSES OF LEAKING BLADDER AND/OR RESERVOIR INCLUDE: BRAKE SYSTEM MAY HAVE TOO MUCH FLUID, BLADDER MAY HAVE SPLIT, AND/OR BLADDER MAY BE CONTAMINATED.**

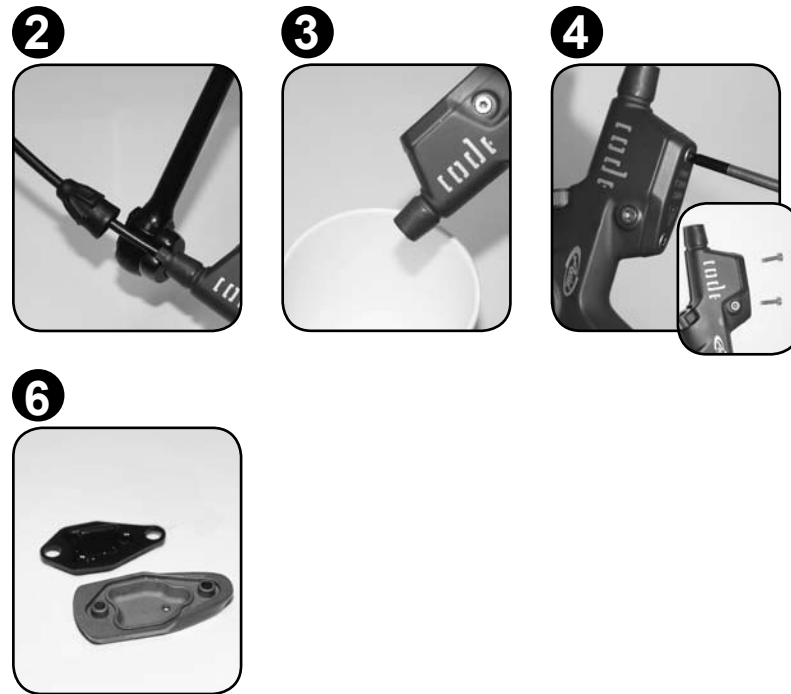

## LEVER OVERHAUL SERVICE INSTRUCTIONS (CONT)

### RESERVOIR COVER/BLADDER REMOVAL (CONT)

7. Insert new bladder into cover and seat flush into underside of reservoir cover. Make sure you have the correct orientation.

**NOTE: DO NOT RE-INSTALL RESERVOIR COVER AT THIS TIME.**

### BLEED SCREWS REMOVAL

8. Using a T-10 Torx wrench, remove both bleed screws.
9. Using a sharp pick, remove both o-rings on bleed screws and replace.
10. Install bleed screws back into lever body.

### LEVER BLADE/CAM REMOVAL

11. Using two 5mm hex wrenches, loosen and remove the lever pivot shoulder bolt and lever pivot sleeve bolt.
12. Rotate the lever and cam assembly toward the handlebar clamp. Carefully remove the lever blade and return spring from the cam.
13. Slide a hex wrench through the bearing in the cam and pull the gently pull the cam off the end of the pushrod.

### INTERNALS REMOVAL

Take a few moments and familiarize yourself with the internal components of your brake lever. This will assist you in identifying the components while you service your brake.

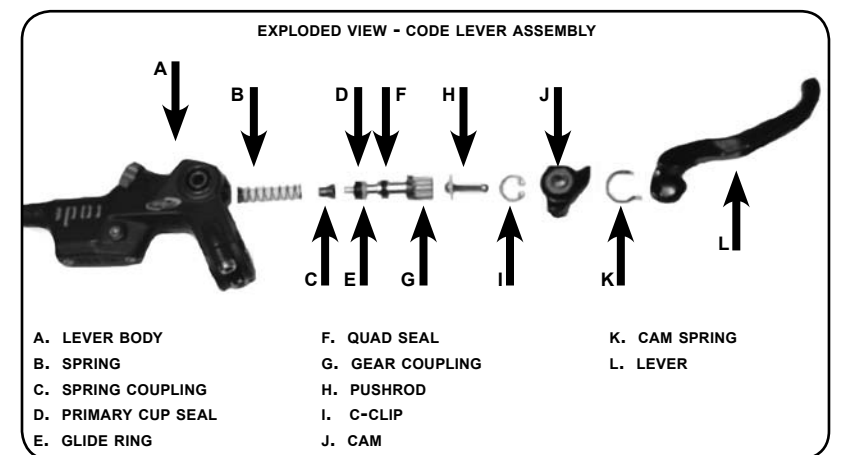
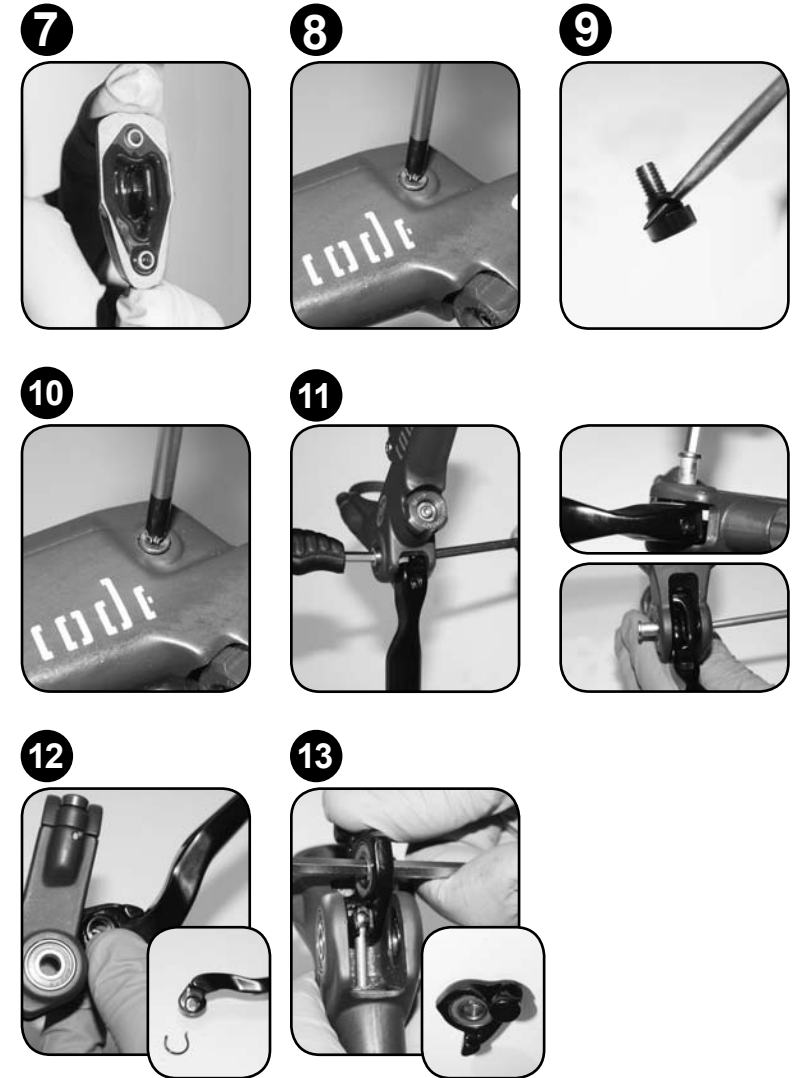

## LEVER OVERHAUL SERVICE INSTRUCTIONS (CONT)

### INTERNALS REMOVAL (CONT)

15. Using snap ring pliers, remove the retaining ring located in the lever body at the base of the push rod. Remove pushrod and internal piston/spring assembly.  
**IMPORTANT: THE INTERNAL PISTON/SPRING ASSEMBLY IS PRELOADED AND WILL COME OUT OF THE LEVER BODY QUICKLY. BE SURE TO POINT THE ASSEMBLY IN A SAFE DIRECTION, OR INTO A PLASTIC BAG.**
16. Using a T-10 Torx wrench, remove the Pad Adjust Knob. Remove the detent ball bearing and spring located directly beneath the Pad Adjust Knob with a pick.
17. Gently push the bevel gear out of the lever body from the backside using a pick or your thumb.

### PISTON/SPRING ASSEMBLY OVERHAUL

18. Remove the spring from the piston/spring assembly.
19. Using a small flathead screwdriver, remove the spring coupling from the piston, followed by the cupseal, glide ring and secondary quadseal o-ring.
20. Install a new quadseal o-ring, followed by the glide ring and a new cupseal with the open end out (not pictured).
21. Install the spring coupling back onto the piston and snap the return spring back onto the spring coupling.

### INTERNALS INSTALLATION

22. Install the bevel gear into the gear bore and hold in place with your finger.
23. Install the detent spring and ball into the lever body.
24. Align the Pad Adjust Knob with the bevel gear and install the knob using a T-10 Torx wrench. Tighten the knob to 1-1.2 Nm (8.7-10.4 in-lbs). The bevel gear should now be secure and you no longer need to hold it in place with your finger.

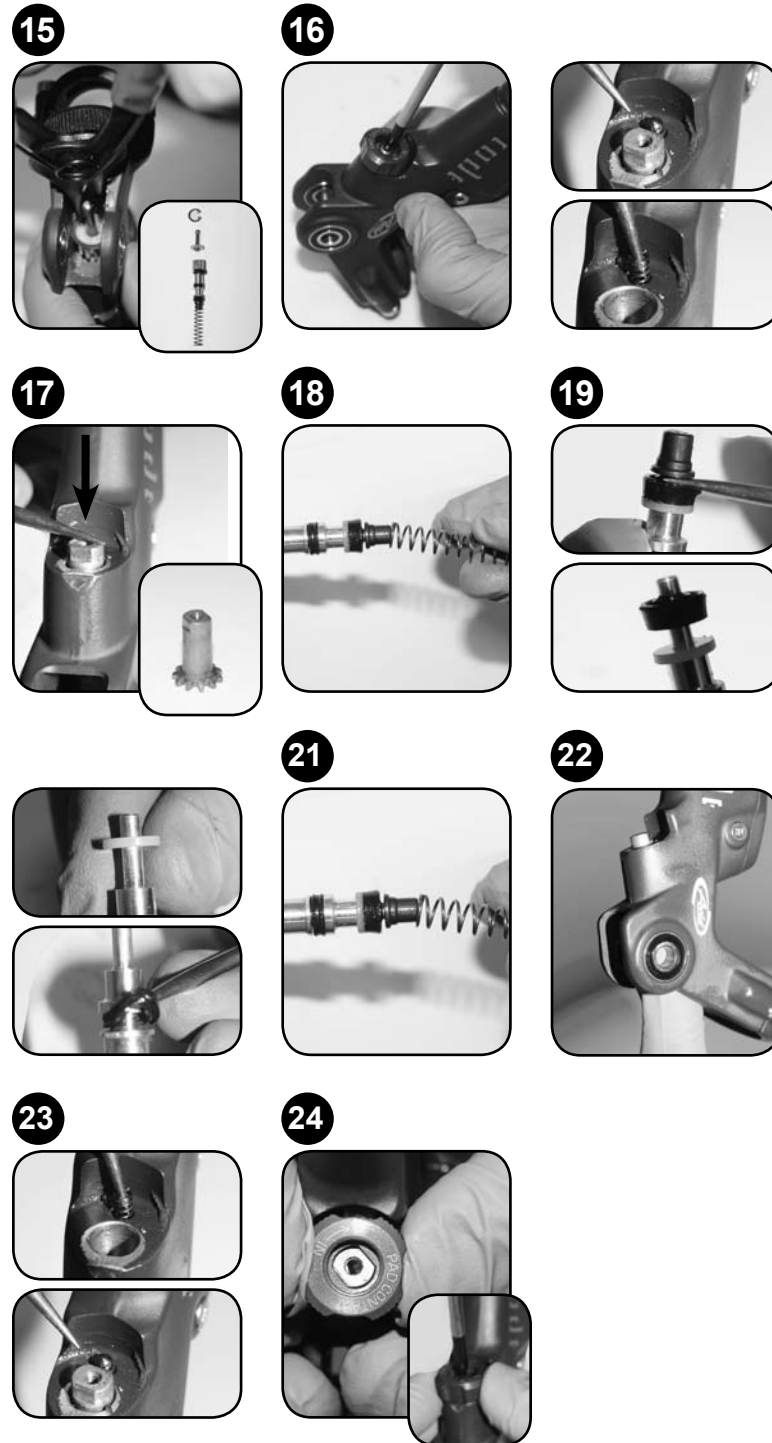

## LEVER OVERHAUL SERVICE INSTRUCTIONS (CONT)

### INTERNALS INSTALLATION (CONT)

25. Install the piston/spring assembly into the lever body.  
**IMPORTANT: ALIGN THE BLACK PISTON KEY ON THE PISTON GEAR INTO THE KEYWAY ON THE LEVER BODY.**
26. Push the piston/spring assembly far enough into the lever body to completely depress the spring. While the spring is depressed, insert a pin gauge (a small drill bit will work) into the compensating port, to hold the assembly compressed in the lever body.  
**IMPORTANT: DO NOT LOOK DIRECTLY INTO LEVER BODY WHILE PERFORMING THIS STEP. DEPRESSING THE SPRING PUTS IT INTO A PRELOADED CONDITION AND IT CAN EJECT RAPIDLY FROM THE LEVER BODY IF THE PIN GAUGE IS NOT PROPERLY INSTALLED.**
27. Install the pushrod then washer onto the top of the piston gear. Install the retaining ring in the groove of the lever body using a pair of snap ring pliers and orient the ring holes away from the lever body opening.
28. Remove the gauge pin from the compensating port. The piston assembly will snap into place against the pushrod and washer.

### LEVER BLADE/CAM INSTALLATION

29. Insert a leg of the lever return spring into the hole on the lever cam.
30. Install the lever blade onto the cam and return spring, making sure the exposed spring leg is seated into the hole on the lever blade. With your thumb, roll the cam on the brake lever so that the lever pivot holes are aligned.  
**NOTE: YOU CAN CUT A 5MM LENGTH SECTION OF A 6MM DIAMETER BOLT AS A TOOL TO HOLD THE CAM AND LEVER BLADE TOGETHER AS YOU INSTALL THE ASSEMBLY TO THE LEVER BODY.**
31. Insert the lever blade assembly into the lever body at a slight angle. The cam coupling should snap firmly onto the exposed pushrod.
32. Rotate the lever so that the pivot and lever body bores are aligned and push the lever pivot sleeve bolt through the bearing. Using a 4mm hex wrench, tighten sleeve bolt to 2-2.5 Nm (17-22 in-lbs).  
**NOTE: IF YOU USED A BOLT TOOL IN STEP 31, INSTALLING THE PIVOT SLEEVE BOLT WILL PUSH OUT THE BOLT TOOL. BE SURE THE BOLT TOOL IS COMPLETELY REMOVED.**



## LEVER OVERHAUL SERVICE INSTRUCTIONS (CONT)

### LEVER BLADE/CAM INSTALLATION (CONT)

33. Squeeze the lever a few times to ensure that the lever depressed and returns fully (not pictured).
34. Rotate the Pad Adjust Knob to the "full in" and the "full out" position to ensure full range of adjustment (not pictured).
35. Install the bladder reservoir cap using a T-10 Torx wrench and tighten to 1-1.2 Nm (8.7-10.4 in-lbs).

35



THIS CONCLUDES THE LEVER OVERHAUL SERVICE INSTRUCTIONS. YOU HAVE DONE A GREAT JOB AND ARE READY TO MOVE ONTO THE NEXT CHAPTER, HYDRAULIC DISC BRAKE CALIPER OVERHAUL. ENJOY!

# DISC BRAKE CALIPER OVERHAUL



# HYDRAULIC DISC BRAKE CALIPER OVERHAUL

## (JUICY 3, 5, 7, CARBON)

### INTRODUCTION

Avid caliper assemblies need to be serviced in order to optimize braking function. If caliper brake piston motion is 'sticky' or lacks a positive and smooth return, the caliper body/brake piston o-ring may be out of place or damaged. If your brake was filled with brake fluid other than DOT 4 or 5.1, damage to all rubber and plastic internal parts may exist. Commonly used INCORRECT fluid is mineral oil or DOT 5, which is silicone based. Inspection and/or replacement of these parts, due to any of the above situations, will improve brake function.

### CALIPER OVERHAUL SERVICE INSTRUCTIONS

#### TROUBLE-SHOOTING -

##### 'STICKY' OR SLOW BRAKE PAD RETURN FEEL

Before completely disassembling your caliper, it's worth trying to loosen the sticky piston. Try the following: Clamp bicycle in bicycle work stand. Spin affected wheel. Lightly squeeze brake lever and watch brake pads when lever is released. Determine which side of the caliper has a slow returning brake piston. Remove caliper from bicycle. If you have a mounting bracket, it is recommended to remove that too or just remove the caliper leaving the bracket on the fork or frame. Using a pair of needle-nosed pliers, remove both brake pads and h-spring. Remove the spring pad clip from the outside of the caliper. Using an 11mm box wrench, press working piston into caliper body. Squeeze brake lever slowly to move sticky piston inward. Press the piston back into the caliper again. Repeat these steps to correct caliper piston inner o-ring position. Both pistons should now be moving freely. Re-install spring pad clip, h-spring, and pads into caliper. Re-install caliper onto bicycle. Spin wheel and check function. If there is no improvement, continue with caliper service.

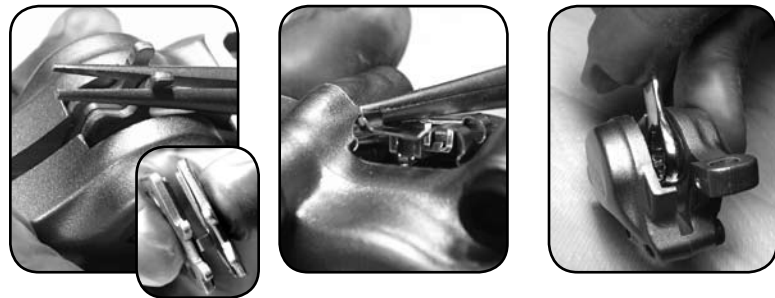

#### GETTING STARTED

1. Remove brake caliper from fork or frame and remove the caliper mounting bracket and CPS hardware from the caliper. Set aside in correct order (not pictured).



#### BRAKE PAD AND H-SPRING REMOVAL

2. Using needle-nosed pliers, grab one of the pad tabs and slide the pad toward the center of the caliper (this disengages the pad backing plate from the post in the center of the piston), then pull the pad straight out. Repeat for other pad.

**NOTE: IF THE H-SPRING DOESN'T COME OUT WITH THE SECOND PAD, PUSH IT OUT FROM THE OPEN TOP OF THE CALIPER WITH A PICK OR YOUR FINGER.**

### CALIPER OVERHAUL SERVICE INSTRUCTIONS (CONT)

#### BRAKE PAD AND H-SPRING REMOVAL (CONT)

3. Remove the spring pad clip from the outside of the caliper.

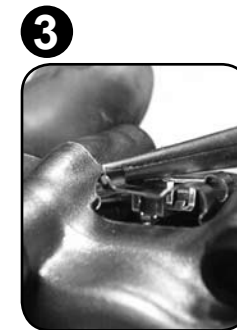

#### BRAKE HOSE/BANJO BOLT REMOVAL AND SERVICE

4. Using an 8mm open-end or box wrench, loosen banjo bolt. Brake fluid will leak, so hold over a container to catch fluid.
5. Pull banjo bolt completely out of caliper. Dump all caliper brake fluid into container.
6. Remove o-rings on each side of brake hose banjo and replace with new o-rings.
7. Insert banjo bolt back into brake hose banjo. Ensure outside banjo o-ring is not damaged by banjo bolt threads. This may cause a leak. Set hose and banjo bolt aside.



#### CALIPER DISASSEMBLY AND SERVICE

8. Loosen all three caliper body bolts with a 4mm hex wrench. There are three different bolt lengths. Set aside in correct order.
9. Separate caliper body halves and open caliper assembly.
10. Using a sharp pick, remove small banjo hole (body half) o-ring.

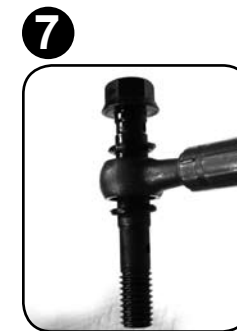

#### BRAKE PISTONS REMOVAL AND SERVICE

11. Inboard Caliper Body Half: Using an air compressor chuck, insert chuck nozzle into banjo bolt hole. Hold caliper in one hand, pointing caliper piston in a safe direction. Squeeze the air chuck and force air into the banjo bolt hole while holding caliper body. Compressed air unseats the caliper piston from the caliper. Pull out completely and remove piston.



**IMPORTANT: BE SURE TO POINT THE CALIPER IN A SAFE DIRECTION. YOU MAY WANT TO DO THIS INSIDE A PLASTIC BAG TO PREVENT THE PISTON CAUSING INJURY OR BECOMING LOST.**

12. Outboard Caliper Body Half: Using an air compressor chuck, insert chuck nozzle into banjo bolt hole. Hold caliper in one hand, pointing caliper piston in a safe direction. Hold one finger over the banjo bolt through-hole on opposite side of caliper body so air does not escape. Squeeze the air chuck and force air into the banjo bolt hole while holding caliper body. Compressed air unseats the caliper piston from the caliper. Pull out completely and remove piston.

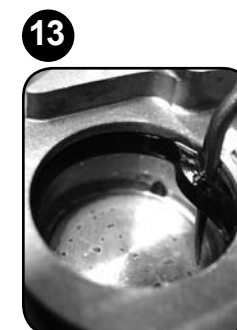

**IMPORTANT: BE SURE TO POINT THE CALIPER IN A SAFE DIRECTION. YOU MAY WANT TO DO THIS INSIDE A PLASTIC BAG TO PREVENT THE PISTON FROM CAUSING INJURY OR BECOMING LOST.**

13. Remove the square-edge o-ring from inside each caliper body half with a sharp pick and replace with new square-edge o-rings.

## CALIPER OVERHAUL SERVICE INSTRUCTIONS (CONT)

### CALIPER ASSEMBLY

14. Inspect caliper pistons for damage and replace if necessary. Re-install caliper brake pistons into each half of the caliper body.
15. Install a new banjo bolt o-ring into the banjo bolt hole on outboard side of caliper body.
16. Insert and thread caliper bolt into caliper closest to banjo bolt hole. Ensure new caliper banjo bolt o-ring is not unseated from its position (not pictured).
17. Insert remaining two caliper body bolts and tighten all three bolts with a 4mm hex wrench to 4.9-5.9 Nm (43 - 52 in-lb).
18. Insert banjo bolt back into caliper into banjo bolt hole. Hand-thread and tighten with 8mm box wrench to 4.9-5.9 Nm (43 - 52 in-lb). Be careful not to pinch either of these o-rings during installation.
19. Using a T-10 Torx wrench, remove banjo bolt bleed screw.
20. Using a sharp pick, remove bleed screw o-ring. This o-ring may be a little hard to see. Replace with a new bleed screw o-ring.
21. Re-install banjo bolt bleed screw into banjo bolt and tighten with T-10 Torx wrench.

14



15



17



18



19



20



21



22



24



### BRAKE PAD INSTALLATION

22. Insert spring pad clip into outer side of caliper.
23. Measure the total thickness of each pad (pad backing plate and pad material). If there is less than 3mm of total width, replace both brake pads (not pictured).
24. Position the h-spring between the two pads. The curved handle of inner pad should face toward inboard side of caliper. Squeeze the pad and spring assembly together, then firmly push into the caliper until it 'clicks' into place, indicating it is properly secured in the caliper body.

### FINISHING UP (NOT PICTURED)

24. Visually check your work. Inspect banjo bolt and banjo for any protruding o-rings. If there are any o-rings that are 'squeezed' beyond the outside edges of the banjo or bolt, remove and replace. Repeat installation steps.
25. Wipe assembled caliper with soapy water to remove any brake fluid.
26. Re-install caliper onto bicycle following the installation and torque specifications called out in the user manual.

THIS CONCLUDES THE CALIPER OVERHAUL SERVICE INSTRUCTIONS. YOU HAVE DONE A GREAT JOB AND ARE READY TO MOVE ONTO THE NEXT CHAPTER, HYDRAULIC DISC BRAKE HOSE LENGTH ADJUSTMENT AND BLEEDING. ENJOY!

## HYDRAULIC DISC BRAKE CALIPER OVERHAUL (JUICY ULTIMATE)

### INTRODUCTION

Avid caliper assemblies need to be serviced in order to optimize braking function. If caliper brake piston motion is 'sticky' or lacks a positive and smooth return, the caliper body/brake piston o-ring may be out of place or damaged. If your brake was filled with brake fluid other than DOT 4 or 5.1, damage to all rubber and plastic internal parts may exist. Commonly used INCORRECT fluid is mineral oil or DOT 5, which is silicone based. Inspection and/or replacement of these parts, due to any of the above situations, will improve brake function.

### CALIPER OVERHAUL SERVICE INSTRUCTIONS

#### TROUBLE-SHOOTING -

##### 'STICKY' OR SLOW BRAKE PAD RETURN FEEL

Before completely disassembling your caliper, it's worth trying to loosen the sticky piston. Try the following: Clamp bicycle in bicycle work stand. Spin affected wheel. Lightly squeeze brake lever and watch brake pads when lever is released. Determine which side of the caliper has a slow returning brake piston. Remove caliper from bicycle. If you have a mounting bracket, it is recommended to remove that too or just remove the caliper leaving the bracket on the fork or frame. Using a pair of needle-nosed pliers, remove both brake pads and h-spring. Using an 11mm box wrench, press working piston into caliper body. Squeeze brake lever slowly to move sticky piston inward. Press the piston back into the caliper again. Repeat these steps to correct caliper piston inner o-ring position. Both pistons should now be moving freely. Re-install h-spring and pads into caliper. Re-install caliper onto bicycle. Spin wheel and check function. If there is no improvement, continue with caliper service.

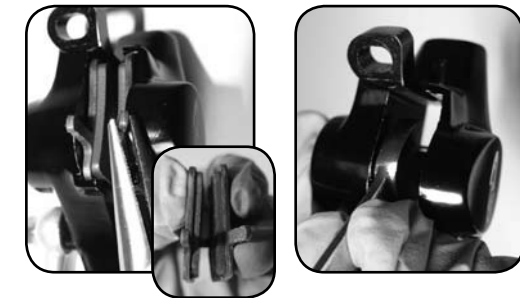

#### GETTING STARTED

1. Remove brake caliper from fork or frame and remove the caliper mounting bracket and CPS hardware from the caliper. Set aside in correct order (not pictured).

#### BRAKE PAD AND H-SPRING REMOVAL

2. Using needle-nosed pliers, grab one of the pad tabs and slide the pad toward the center of the caliper (this disengages the pad backing plate from the post in the center of the piston), then pull the pad straight out. Repeat for other pad.

NOTE: IF THE H-SPRING DOESN'T COME OUT WITH THE SECOND PAD, PUSH IT OUT FROM THE OPEN TOP OF THE CALIPER WITH A PICK OR YOUR FINGER.





## CALIPER OVERHAUL SERVICE INSTRUCTIONS (CONT)

### BRAKE HOSE/BANJO BOLT REMOVAL AND SERVICE

- Using an 8mm open-end or box wrench, loosen banjo bolt. Brake fluid will leak, so hold over a container to catch fluid.
- Pull banjo bolt completely out of caliper. Pour all caliper brake fluid into container.
- Remove o-ring from brake hose banjo and banjo bolt and replace with new o-rings.
- Insert banjo bolt back into brake hose banjo. Ensure outside banjo o-ring is not damaged by banjo bolt threads. This may cause a leak. Set hose and banjo bolt aside.

3



4



5



6



7



8



### BRAKE PISTON REMOVAL AND SERVICE

- Using an 11mm box wrench, gently push outboard piston into caliper body until it is flush with the inside of the caliper.
- Gently press a flathead screwdriver against the outboard piston while pointing the caliper in a safe direction (you want to remove the inboard piston first, so you need to hold the outboard piston in place). Using an air compressor chuck, insert chuck nozzle into banjo bolt through hole. Squeeze the air chuck and force air into the banjo bolt hole. Compressed air unseats the inboard caliper piston from the caliper. Pull the piston out of the caliper body through pad opening.

**NOTE:** YOU MAY NEED TO USE A PAIR OF NEEDLE NOSED PLIERS TO PULL THE PISTON OUT OF THE CALIPER BODY. BE CAREFUL NOT TO SCRATCH THE PISTON. IF YOU SCRATCH THE PISTON, YOU WILL NEED TO REPLACE IT.

**IMPORTANT:** BE SURE TO POINT THE CALIPER IN A SAFE DIRECTION. YOU MAY WANT TO DO THIS INSIDE A PLASTIC BAG TO PREVENT THE PISTON FROM CAUSING INJURY OR BECOMING LOST.

- Using an 8mm hex wrench, turn the piston cap clockwise to push the outboard piston into and out of the caliper body. Pull the piston out of the caliper body through the pad opening.
  - Press the piston cap into the caliper body and remove through the pad opening.
  - Using a sharp pick, remove the piston cap o-ring and replace with a new o-ring.
  - Using a sharp pick, remove the inboard and outboard quad seal o-rings from the caliper body and replace with new o-rings.
- NOTE:** WHEN INSTALLING THE NEW QUAD SEAL O-RINGS, USE THE FLAT SIDE OF A PICK TO SEAT THE O-RING INTO THE O-RING GROOVE BY MOVING IT AROUND THE ENTIRE SEAL.
- Using a T-10 Torx, remove caliper body assembly bleed screw.
  - Using a sharp pick, remove bleed screw o-ring and replace with a new one.

9



10



11



12



13



14



## CALIPER OVERHAUL SERVICE INSTRUCTIONS (CONT)

### BRAKE PISTON INSTALLATION

- Inspect caliper pistons for damage and replace if necessary (not pictured).
- Install inboard piston through the pad opening, pressing it flush into the caliper body with an 11mm box wrench.
- Install piston cap through pad opening. Using an 8mm hex wrench, thread piston cap counterclockwise until snug into caliper body.
- Install the outboard piston through the pad opening and press it flush into the caliper body with an 11mm box wrench.
- Using a T-10 Torx, install caliper body assembly bleed screw.

### BRAKE HOSE/BANJO BOLT INSTALLATION

- Insert banjo bolt back into caliper banjo bolt hole setting the banjo angle to the desired angle. Hand-thread and tighten with 8mm box wrench to 4.9-5.9 Nm (43 - 52 in-lb). Be careful not to pinch the banjo bolt o-ring during installation.
- Using a T-10 Torx wrench, remove banjo bolt bleed screw.
- Using a sharp pick, remove bleed screw o-ring. This o-ring may be a little hard to see. Replace with a new bleed screw o-ring.
- Re-install banjo bolt bleed screw into banjo bolt and tighten with T-10 Torx wrench.

### BRAKE PAD INSTALLATION

- Measure the total thickness of each pad (pad backing plate and pad material). If there is less than 3mm of total width, replace both brake pads (not pictured).
- Position the h-spring between the two pads. The curved handle of inner pad should face toward inboard side of caliper. Squeeze the pad and spring assembly together, then firmly push into the caliper until it 'clicks' into place, indicating it is properly secured in the caliper body.

16



17



18



19



20



21



22



23



25



## CALIPER OVERHAUL SERVICE INSTRUCTIONS (CONT)

### FINISHING UP (NOT PICTURED)

24. Visually check your work. Inspect banjo bolt and banjo for any protruding o-rings. If there are any o-rings that are 'squeezed' beyond the outside edges of the banjo or bolt, remove and replace. Repeat installation steps.
25. Wipe assembled caliper with soapy water to remove any brake fluid.
26. Re-install caliper onto bicycle following the installation and torque specifications called out in the user manual.

THIS CONCLUDES THE CALIPER OVERHAUL SERVICE INSTRUCTIONS. YOU HAVE DONE A GREAT JOB AND ARE READY TO MOVE ONTO THE NEXT CHAPTER, HYDRAULIC DISC BRAKE HOSE LENGTH ADJUSTMENT AND BLEEDING. ENJOY!

## HYDRAULIC DISC BRAKE CALIPER OVERHAUL (CODE)

### INTRODUCTION

Avid caliper assemblies need to be serviced in order to optimize braking function. If caliper brake piston motion is 'sticky' or lacks a positive and smooth return, the caliper body/brake piston o-ring may be out of place or damaged. If your brake was filled with brake fluid other than DOT 4 or 5.1, damage to all rubber and plastic internal parts may exist. Commonly used INCORRECT fluid is mineral oil or DOT 5, which is silicone based. Inspection and/or replacement of these parts, due to any of the above situations, will improve brake function.

### CALIPER OVERHAUL SERVICE INSTRUCTIONS

#### TROUBLE-SHOOTING -

##### 'STICKY' OR SLOW BRAKE PAD RETURN FEEL

Before completely disassembling your caliper, it's worth trying to loosen the sticky piston. To do so, try the following: Clamp bicycle in bicycle work stand. Spin affected wheel. Lightly squeeze brake lever and watch brake pads when lever is released. Determine which side of the caliper has a slow returning brake piston. Remove caliper from bicycle. If you have a mounting bracket, it is recommended to remove that too or just remove the caliper leaving the bracket on the fork or frame. Remove e-clip from guide pin groove on top of the caliper using a sharp pick. Using a 2.5mm hex wrench remove the guide pin from the caliper. Pull and remove both brake pads and h-spring. Using a 10mm box wrench, press working piston into caliper body. Squeeze brake lever slowly to move sticky piston inward. Press the piston back into the caliper again. Repeat these steps to correct caliper piston inner o-ring piston. Both pistons should now be moving freely. Re-install spring pad clip, h-spring, and pads into caliper. Re-install caliper onto bicycle. Spin wheel, check function. If there is no improvement, continue with caliper service.



#### GETTING STARTED

1. Remove brake caliper from fork or frame and remove caliper mounting bracket and CPS hardware from caliper. Set aside in correct order (not pictured).

## CALIPER OVERHAUL SERVICE INSTRUCTIONS (CONT)

### BRAKE PADS AND PAD H-SPRING REMOVAL

- Remove e-clip from guide pin groove on top of the caliper using a sharp pick.
- Using a 2.5mm hex wrench remove the guide pin from the caliper.
- Squeeze the pads together so they clear the pistons, and pull to remove brake pads and h-spring from caliper.

### CALIPER DISASSEMBLY AND SERVICE

- Using a 4mm hex wrench, loosen all four caliper body bolts until there is slight gap in the caliper halves. This will ease banjo bolt removal.
- Using two 4mm hex wrenches, loosen and remove the banjo sleeve bolt and banjo shoulder bolt.
- Completely remove all four caliper body bolts, separate the caliper body into its two halves and remove the banjo.
- Using a sharp pick, remove the o-rings from underneath the heads of both the banjo sleeve bolt and banjo shoulder bolt and replace with new o-rings.
- Using a sharp pick, remove the banjo o-rings on both the right and left side of the caliper halves and replace with new o-rings.

### BRAKE PISTON REMOVAL AND SERVICE

- Using an air compressor chuck, insert chuck nozzle into banjo bolt hole. Hold caliper in a rag in one hand, using your thumb or finger to seal the backside of the banjo bolt hole. Squeeze the air chuck and force air into the banjo bolt hole. The compressed air will unseat the caliper piston from the piston pockets.

**IMPORTANT: BE SURE TO POINT THE CALIPER IN A SAFE DIRECTION. YOU MAY WANT TO DO THIS INSIDE A PLASTIC BAG TO PREVENT THE PISTON FROM CAUSING INJURY OR BECOMING LOST.**

**NOTE: BECAUSE OF THE NATURE OF A FOUR PISTON CALIPER, BOTH PISTONS IN EACH HALF OF THE CALIPER MAY NOT BE UNSEATED SIMULTANEOUSLY. TO REMOVE THE SECOND PISTON USE YOUR THUMB TO SEAL THE EMPTY PISTON POCKET OR FIND A METRIC SOCKET EXTENSION THAT FITS SNUGLY INTO THE PISTON POCKET AND SEAL THE TOP OF THE EXTENSION WITH YOUR THUMB. REPEAT STEP 10 TO REMOVE THE LAST PISTON.**

- Remove the square edge o-ring from inside each piston pocket using a sharp pick and place with new o-rings.
- Remove both banjo bolt bleed screws from the top of the caliper body using a T-10 Torx wrench.
- Remove the o-rings from the bleed screws and replace with new o-rings.

2



3



4



5



6



7



8



9



10



11



12



13



## CALIPER OVERHAUL SERVICE INSTRUCTIONS (CONT)

### CALIPER ASSEMBLY

- Inspect the caliper pistons for damage, and replace if necessary. Insert the caliper brake pistons back into each half of the caliper body.
- NOTE: GENTLY ROLLING THE PISTONS CLOCKWISE AS YOU INSTALL WILL HELP WITH INSTALLATION.**
- Place banjo sleeve bolt into the left half (outboard side) of the caliper. Slide banjo onto the sleeve bolt and set the banjo angle to the desired angle.
  - Align both caliper halves together and insert the banjo shoulder bolt and the four caliper body bolts. Using two 4mm hex wrench, tighten the banjo bolt to 2.9-3.4Nm (26-30in-lb). Using a 4mm hex wrench tighten the caliper body bolts to 5.9-6.3Nm (52-56in-lb).
  - Using a T-10 Torx, install the two bleed screws back into the top of the caliper body and tighten to .6-.7Nm (5-6in-lb).

### BRAKE PAD INSTALLATION

- Inspect and measure each brake pad. If there is less than 3mm of total pad thickness (pad backing and pad friction material), replace both brake pads (not pictured).
  - Position the h-spring between the two pads.
- NOTE: THE CODE PADS ARE SYMMETRICAL, THERE IS NOT A LEFT OR RIGHT ORIENTATION.**
- Locate the "pad installation" feature of the pad spacer tool. Insert the pad handles into the "pad installation" tool so it holds the pads together.
  - Insert the pads and pad tool into the caliper until the holes in the top of the pads are aligned with the guide pin holes in the top of the caliper.
  - Insert the guide pin through the caliper body halves and the brake pads. Using a 2.5mm hex wrench, tighten the guide pin to 1.5-1.9Nm (13-17 in-lb).
  - Remove the pad tool. The h-spring will snap the pads into position.
  - Using your thumb or finger, install the e-clip into the groove on the end of the guide pin.

14



15



16



17



18



19



20



21



22



23



24



25





## CALIPER OVERHAUL SERVICE INSTRUCTIONS (CONT)

### FINISHING UP (NOT PICTURED)

27. Visually check your work. Inspect banjo bolt and banjo for any protruding o-rings. If there are any o-rings that are 'squeezed' beyond the outside edges of the banjo or bolt, re-move and replace. Repeat installation steps.
28. Wipe assembled caliper with soapy water to remove any brake fluid.
29. Re-install caliper onto bicycle following the installation and torque specifications called out in the user manual.

THIS CONCLUDES THE CALIPER OVERHAUL SERVICE INSTRUCTIONS. YOU HAVE DONE A GREAT JOB AND ARE READY TO MOVE ONTO THE NEXT CHAPTER, HYDRAULIC DISC BRAKE HOSE LENGTH ADJUSTMENT AND BLEEDING. ENJOY!

## BALL BEARING DISC BRAKE CALIPER OVERHAUL (BB7)

### INTRODUCTION

Avid caliper assemblies need to be serviced in order to optimize braking function. If caliper brake piston motion is 'sticky' or lacks a positive and smooth return, the caliper body/brake piston o-ring may be out of place or damaged. Inspection and/or replacement of these parts, due to any of the above situations, will improve brake function.

**IMPORTANT: AVID'S BALL BEARING DISC BRAKE CALIPERS ARE A ONE PIECE BODY THAT INCORPORATE TWO TRUSS BOLTS FOR STRENGTH. THESE BOLTS HAVE TAMPER-PROOF HEADS AND ARE NOT TO BE REMOVED FOR ANY REASON!**

### CALIPER OVERHAUL DISASSEMBLY SERVICE INSTRUCTIONS

#### TROUBLE-SHOOTING (NOT PICTURED)

The most common issue with the BB7 is that the outboard pressure foot can become dislodged if the outboard adjustment knob is turned too far clockwise without the rotor in the caliper (wheel off or caliper removed). The brake is not broken, nor does it require disassembly to replace the pressure foot. To replace the pressure foot, turn the outboard adjuster knob counter-clockwise until it stops. If the knob doesn't stop, then the foot screw (the end of which can be seen in the center of the knob) has become disengaged from the knob and possibly from the threads inside the drive cam. In this case, remove the knob, then using a pair of small needle-nosed pliers or a schrader valve tool, turn the the foot screw all the way back out until it stops. Now the pressure foot can be replaced. Relocate the pressure foot into the bore, then give it a firm push in the center. It will click back into place. If you removed the knob, replace it and you're done!

#### GETTING STARTED

1. Remove the cable anchor bolt and plate, then pull the cable housing and inner wire free of the caliper.

#### REMOVE THE OUTBOARD KNOB

2. Turn the outboard pad knob counter-clockwise until it stops, then turn back clockwise three full turns to recess the foot screw in the knob.

**NOTE: TURNING THE OUTBOARD KNOB MORE THAN THREE FULL TURNS CAN DISLODGE THE OUTER PRESSURE FOOT FROM THE DRIVE CAM. IF THIS HAPPENS, PROCEED WITH REMOVING THE KNOB. AFTER STEP 4, THE PRESSURE FOOT CAN BE PRESSED BACK INTO PLACE.**

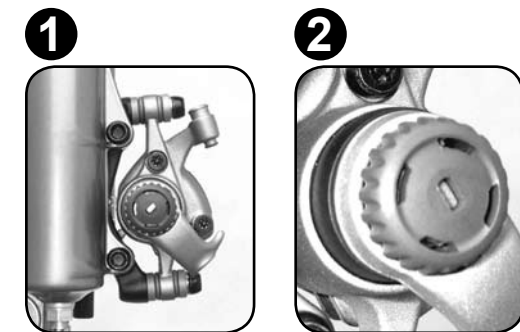

## CALIPER OVERHAUL DISASSEMBLY SERVICE INSTRUCTIONS (CONT)

### REMOVE THE OUTBOARD KNOB (CONT)

3. Remove the knob with a small flat-head screwdriver. Be careful not to mar the surface of the torque arm.
4. Turn the foot screw which is now exposed counter-clockwise until it stops.

3



4



5

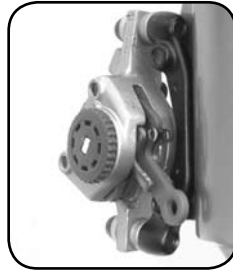

### INSTALL PAD SPACER

5. Turn the inboard adjuster counter-clockwise until there is enough clearance between the pads for a 2mm pad spacer. Insert the spacer, then turn the inboard knob clockwise until it stops. Check the torque arm for movement. If it moves, turn the foot screw clockwise until it is secure.

**NOTE: IF YOU NEED TO FABRICATE A PAD SPACER, USE CARDBOARD OR SOMETHING SIMILAR THAT WILL NOT DAMAGE THE SURFACE OF THE BRAKE PAD.**

6



7



8

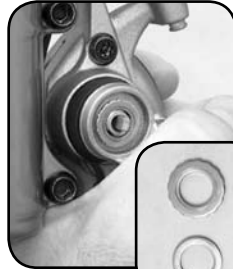

### REMOVE TORQUE ARM

6. Place your thumb over the spring loaded torque arm and hold securely.
7. Remove the torque arm fixing nut using an 11mm wrench.
8. While continuing to hold the torque arm, remove the indexed washer and flat washer.
9. Remove the torque arm, spring adjuster, outer body seal, and spring all together. Then remove the hex-hole washer.
10. Tip the bike and allow the lockring retainer to fall into your hand.

9



10



11



### REMOVE LOCKRING AND CAMS

11. Using the Avid MDT-1 Lockring Tool and a 3/8 drive ratchet, break the lockring free. Then using a 5mm hex, remove the caliper from the bike.
12. Using the MDT-1 by hand, completely remove the lockring.
13. Pull out the cam/outboard pressure foot assembly. Once this assembly is out, remove the pads and pad spacer from the caliper.

12



13



## CALIPER OVERHAUL DISASSEMBLY SERVICE INSTRUCTIONS (CONT)

### REMOVE PRESSURE FOOT AND INNER BODY SEAL

14. Using a small flat-head screwdriver, remove the inboard adjuster knob.
15. Turn the inboard pressure foot clockwise until it is free. Remove pressure foot through the main body bore.
16. There is a split in the body seal which aids in installation and removal. Engage the seal at the split with a small sharp tool and carefully remove it.

14



15



16



### CAM DISASSEMBLY

17. Lift the fixed cam off the drive cam. Be careful not to lose any of the three ball bearings.
18. Use small needle-nosed pliers or a schrader valve core tool to turn the foot screw until it is completely unthreaded from the drive cam.

17



18



## CALIPER OVERHAUL CLEANING & INSPECTION INSTRUCTIONS

### CLEANING

19. Clean all metal parts in solvent, including the cable anchor bolt and plate. Clean the cable seal boots, outer caliper body seal, and inner body seal in mild soap and water. Rinse and dry all parts completely (not pictured).

20



21

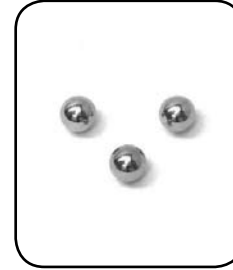

### CALIPER BODY INSPECTION

20. Inspect the caliper body for any damage; pay close attention to all threaded surfaces and the pad retainer clip in the top of the caliper body.

22



22

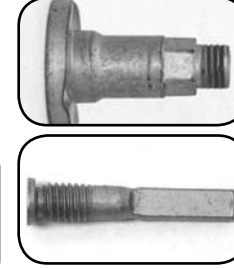

### SMALL PART INSPECTION

21. Check ball bearing and cam ramps for excessive wear.
- NOTE: IT IS NORMAL TO SEE BALL TRACKS IN THE CAM RAMPS.**
22. Check the threads of the drive cam, foot screw, lockring, inner pressure foot, cable anchor bolt, and torque arm fixing nut for damage.
23. Check the spring for any signs of damage.

23

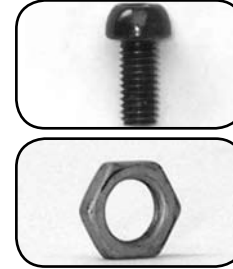

23

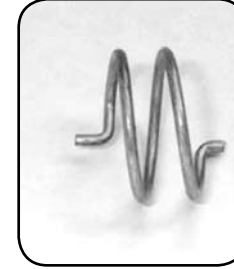

## CALIPER OVERHAUL ASSEMBLY SERVICE INSTRUCTIONS

### SMALL PART INSPECTION (CONT)

24. Check the inner body seal, outer body seal, and cable seal boots for nicks, tears, or cracking.

### ASSEMBLE CALIPER

25. Orient the inner body seal with the groove facing down. Insert the seal into the main body bore. Locate the seal into its recess and seat it completely with your finger.
26. Very lightly, grease the entire body bore including the lockring threads, the inner pressure foot threads, and the inner knob detents.
27. Drop the inner pressure foot in through the main body bore, then thread it counter-clockwise until it bottoms out.
28. Install the inboard adjuster knob by lining up the rectangular tab on the back of the pressure foot with the hole in the knob, then pressing it on firmly.
29. Re-mount the caliper onto the bike.
30. Install the pads and spacer into the caliper and turn the inboard adjuster knob clockwise to lock into place.

### ASSEMBLE CAM

31. Very lightly, grease the foot screw threads, tip of stem-end on outer pressure foot, and the ramps of the drive cam and fixed cam.
32. Using small needle-nosed pliers or a schrader valve tool, thread the foot screw into the drive cam completely, but do not tighten.
33. Engage the stem-end of the outer pressure foot into the hole in the end of the drive cam and install by firmly pressing it straight in.
34. Place the ball bearings into the ramps of the drive cam, then install the fixed cam over the shaft of the drive cam. Rotate the cams against each other to ensure the ball bearings are seated properly in both sets of ramps.

### INSTALL CAM ASSEMBLY AND LOCKRING

35. Hold the cam assembly by the drive cam while keeping pressure on the fixed cam with your thumb and index finger. This serves two functions: first, it keeps the ball bearings properly positioned in their ramps and second, it ensures the drive cam is not pushed past the inner body seal. If the drive cam is pushed past the inner body seal and then pulled back, the edge of the inner body seal rolls back. If this occurs, the seal must be replaced.

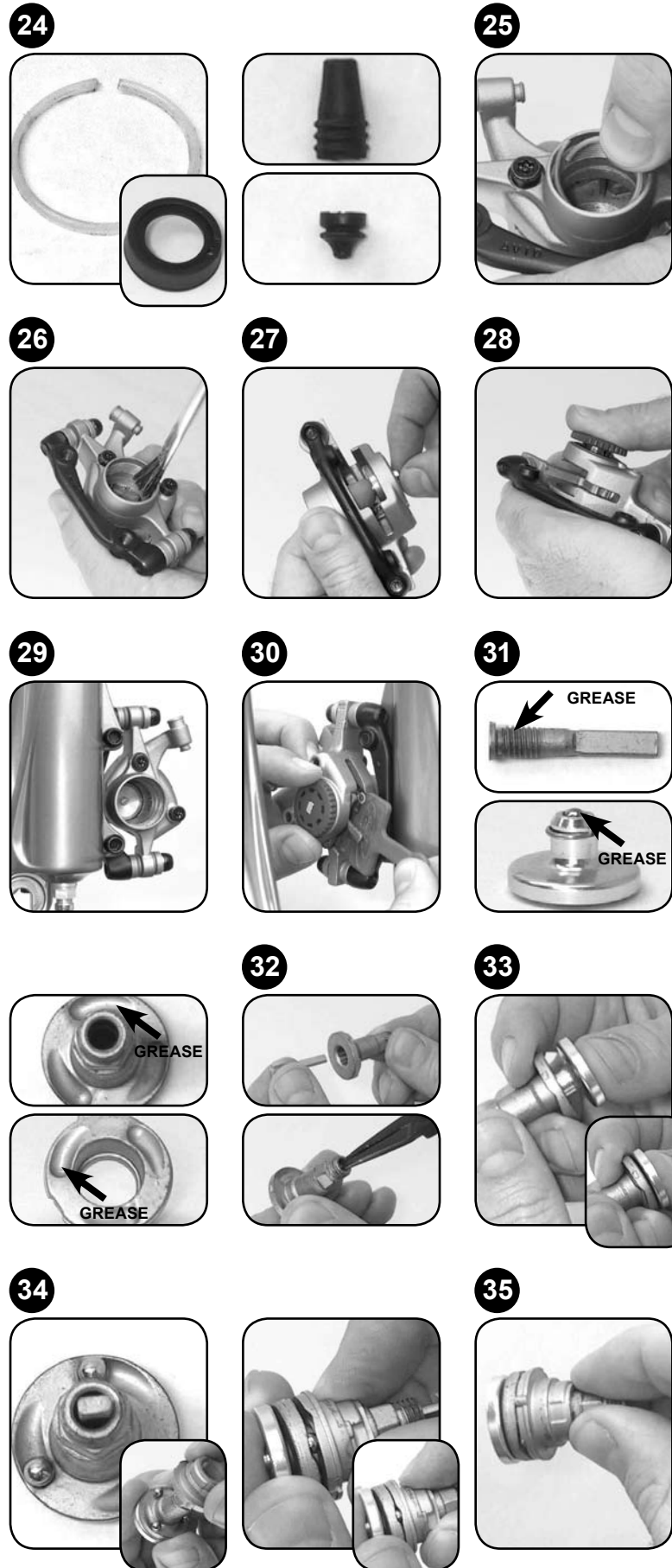

## CALIPER OVERHAUL ASSEMBLY SERVICE INSTRUCTIONS

### INSTALL CAM ASSEMBLY AND LOCKRING

36. Align the tab on the fixed cam to the corresponding groove in the caliper body. Install the assembly, being sure to press it in by the fixed cam, not the shaft of the drive cams.
37. Install the lockring by hand with the MDT-1 tool.
38. Torque the lockring with the MDT-1 tool to 140-150 in-lb.
39. Install the lockring retainer, aligning the tab on the retainer with the cut-out in the fixed cam.

### INSTALL SPRING ADJUSTER

40. Place the hex-hole washer over the drive cam shaft, engaging the flats on the shaft.
41. Apply a high-strength thread-lock such as Loctite 272 to the drive cam threads. Be careful not to allow any thread-lock to enter the area around the foot screw.
42. Install the spring with the long spring tab engaging the hole in the fixed cam.
43. Place the outer body seal on the spring, engaging the spring tab into the hole in the boot.
44. Turn the spring adjuster screw counter-clockwise until the bottom is flush with the bottom of the adjuster. Then install the spring adjuster on top of the outer body seal, engaging the spring tab into the hole in the spring adjuster.

### IMPORTANT: PART & TOOL ORIENTATION

TAKE A MOMENT TO ARRANGE AND ORIENT THE FLAT WASHER, DETENT WASHER, AND TORQUE ARM FIXING NUT FOR INSTALLATION. THIS WILL MAKE THEM MUCH EASIER TO INSTALL WHILE HOLDING THE SPRING-LOADED TORQUE ARM IN PLACE. AFTER THE TORQUE ARM IS ON, THE INSTALLATION ORDER WILL BE AS STATED - FLAT WASHER, DETENT WASHER, THEN TORQUE ARM FIXING NUT. OF THESE PIECES, THE DETENT WASHER IS THE ONLY ONE WITH A "RIGHT-SIDE UP" AND "UP-SIDE DOWN" ORIENTATION. LOOK AT THE DETENT WASHER PROFILE. THERE IS A SHARP EDGE AND A ROUNDED EDGE. THE ROUNDED EDGE GOES UP. THIS ALLOWS THE OUTBOARD ADJUSTMENT KNOB TO BE INSTALLED FAIRLY EASILY AS IT IS PRESSED ON OVER THE ROUNDED OUTER EDGE, WHILE THE SHARP INNER EDGE KEEPS IT FIRMLY IN PLACE.

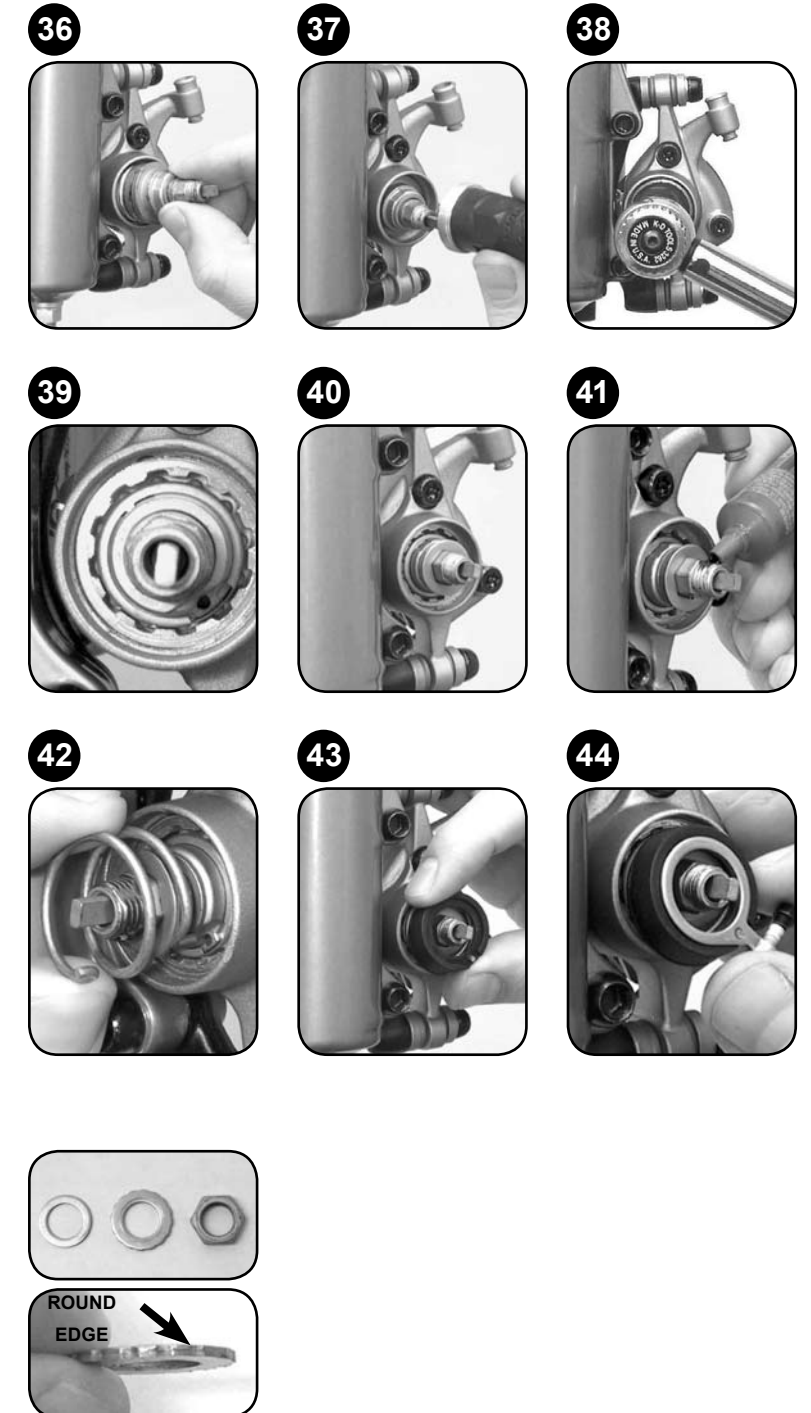

## CALIPER OVERHAUL ASSEMBLY SERVICE INSTRUCTIONS

### INSTALL TORQUE ARM

45. Install the torque arm, aligning the spring adjuster tab and screw with the relieved area on the back of the torque arm. When engaged correctly, the spring adjuster screw will be driven against the shelf on the back of the torque arm. Press the torque arm onto the flats of the drive cam shaft. Make sure the arm is fully seated and hold firmly with your thumb.
46. Place the flat washer over the drive cam shaft and against the torque arm.
47. Place the detent washer over the drive cam shaft and against the flat washer with the rounded edge up.
48. Thread on the torque arm fixing nut by hand, then torque to 55-60in-lb.

**IMPORTANT: DO NOT OVER TIGHTEN THE TORQUE ARM FIXING NUT.**

### INSTALL OUTER KNOB

49. Install the outboard adjuster knob by aligning the rectangle tab of the foot screw with the rectangular hole in the the knob, then press it on firmly.
50. Push the upper and lower boots onto the integrated cable stop.
51. Place the cable anchor plate on the cable anchor bolt, grease the bolt lightly and install into the torque arm
52. Turn both pad adjuster knobs completely counter-clockwise and remove the pad spacer.
53. Set up the brake by following the procedures in the Avid Ball Bearing Disk Brake Installation Guidelines. Be sure to torque to the proper value.

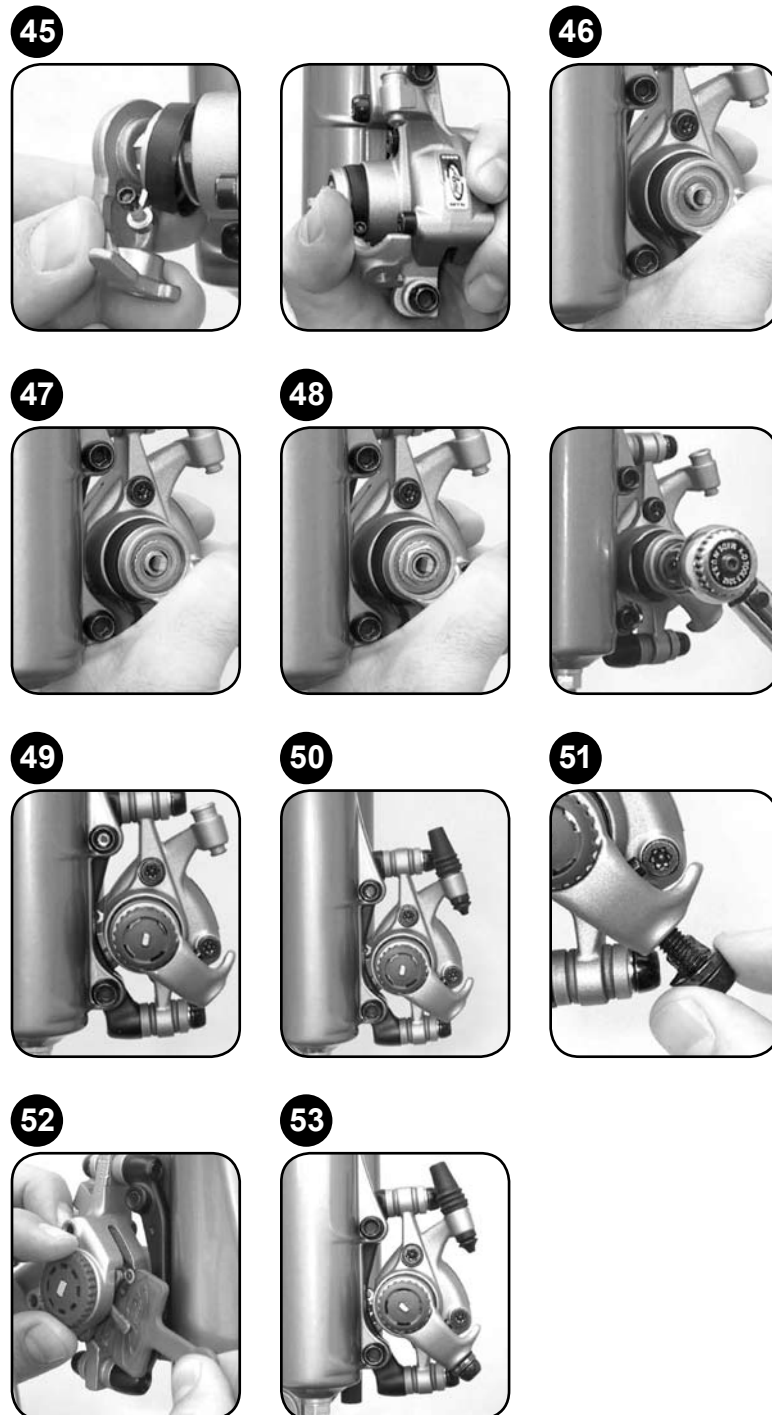

# HYDRAULIC DISC BRAKE HOSE LENGTH ADJUSTMENT & BLEEDING

## COMPLETING BALL BEARING DISC BRAKE CALIPER OVERHAUL

You are almost ready to ride, but first it's a good idea to test your brakes by pulling on the lever extremely hard (as hard as you can imagine yourself pulling the lever while you're riding) several times. Check that the caliper closes and returns properly. Make one last check of all the bolts and fittings.

If everything checks out, **YOU ARE READY TO RIDE!**



# HYDRAULIC DISC BRAKE HOSE LENGTH ADJUSTMENT & BLEEDING (JUICY 3, 5, 7, CARBON, ULTIMATE - CODE)

## INTRODUCTION

Avid brakes come with the hoses attached and bled. If you don't need to change the hose length, then you should not need to bleed the system again. Bleeding is one of the most important steps in topping off the performance of any hydraulic brake system. Any air inside a hydraulic brake system degrades the performance of the brake. The goal of bleeding is to remove the air that is trapped in the hoses, caliper or lever. When you bleed Avid brakes you remove more air than any other brake's bleeding procedure does. That is one of the reasons why Avid brakes are the most powerful and precise hydraulic brakes on the market.

## CHANGING HOSE LENGTHS

HERE ARE THE PARTS THAT YOU'LL BE DEALING WITH IN THE HOSE ADJUSTMENT AND BLEEDING PROCESS. PLEASE TAKE THE TIME TO FAMILIARIZE YOURSELF WITH THE PICTURES AT THE RIGHT.

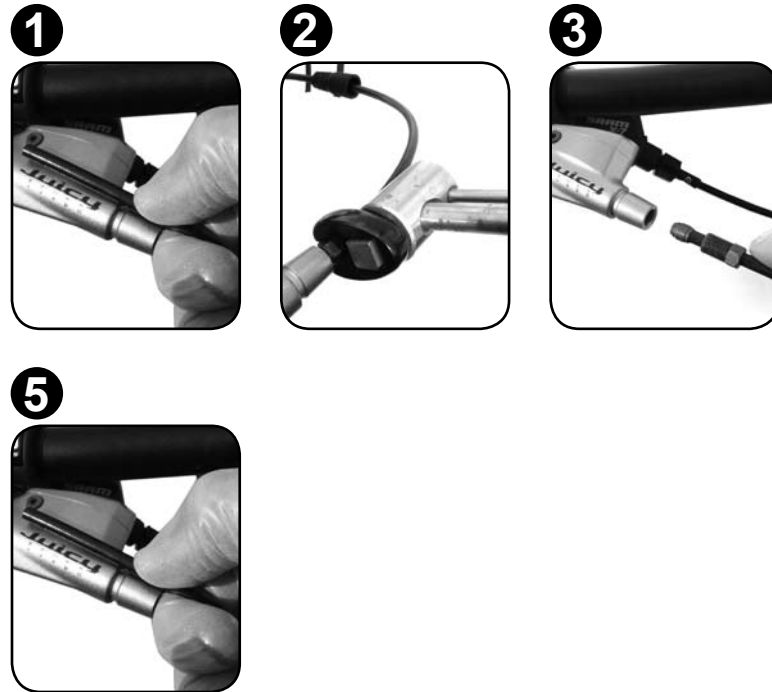

- RE-CHECK HOSE ROUTING**
1. Since you can't lengthen the hose after you have cut it, take a moment and re-check the routing of the hoses. Be sure to account for suspension movement and check that the bars turn freely by turning the bars all the way from side to side. Make sure the hoses are properly secured as well.

- REMOVE HOSE FROM LEVER**
2. If your model has a boot, pull it away from the lever, then use a crow's foot wrench to unscrew the hose compression nut. If the boot sticks, carefully pull a corner of the boot up with something that won't harm it (like a pencil tip) and spray a little alcohol between the boot and the lever. Once you work the alcohol in a little, the boot should loosen up.
  3. Pull the hose from the lever. Wiggle the hose if necessary. Be careful to spill as little DOT fluid as possible. Any DOT that drips out will create bubbles that you'll have to eliminate later.
  4. Slide the nut and boot (if applicable) down the hose and away from the end where you'll be cutting. Be careful not to engage the lever while the hose is removed (not pictured).

- DETERMINE PROPER HOSE LENGTH & CUT**
5. Determine where you need to cut the hose by holding it up to the lever in the position you would like it. The groove in the lever nose marks the spot where you will cut the hose. Make sure to leave a gentle curve in the hose, with enough length to freely turn the handlebar. Double-check this part, because you can't go back after you cut.

## CHANGING HOSE LENGTHS (CONT)

6. Cut the hose using hydraulic hose cutters (not pictured).  
**NOTE: CODE ONLY - WHILE WE RECOMMEND YOU ADJUST THE HOSE LENGTH ON THE LEVER END OF THE HOSE, YOU CAN ADJUST THE CALIPER END OF THE HOSE BY FOLLOWING THE SAME BASIC PROCEDURE.**

- INSTALL NEW FITTINGS**
7. While holding the hose firmly, thread a new hose barb into the end of the hose using a 2.5mm hex wrench.
  8. Slide a new compression fitting over the end of the hose with the new hose barb.

- RE-INSTALL THE HOSE**
9. Push the hose firmly into the lever until it stops.
  10. While holding the hose in place, slide the compression fitting and compression nut up to the lever, then finger-tighten the nut. You may need to wiggle the hose.
  11. While continuing to push the hose into the lever body, use the nut wrench to tighten the compression nut. When you feel the compression nut hit the compression fitting, tighten approximately another 1½ turns, at which point you will feel the compression fitting is bottom out. If your compression fitting is alloy, tighten to 5Nm (47in-lb). If your compression fitting is steel, tighten to 7.8Nm (70in-lb).
  12. Slide the boot (if applicable) back into place (not pictured).

**IMPORTANT: CUTTING DOWN THE HOSE INTRODUCES A SMALL AMOUNT OF AIR INTO THE SYSTEM, WHICH CAN DEGRADE THE PERFORMANCE OF YOUR BRAKES. AT THIS POINT, IT IS NECESSARY TO BLEED THE BRAKES TO RESTORE THEM TO OPTIMAL PERFORMANCE. PLEASE CONTINUE ONTO "BLEEDING PROCEDURES".**

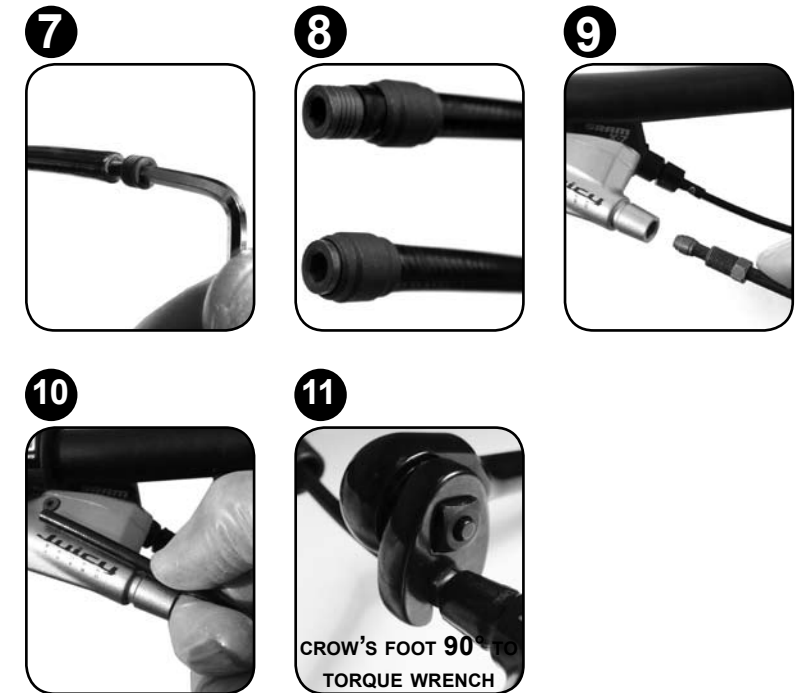

## BLEEDING PROCEDURE

REMEMBER, WHEN BLEEDING THE BRAKES, YOU ARE SIMPLY CHASING BUBBLES OUT OF THE SYSTEM, SO GRAVITY IS YOUR FRIEND (LIQUID IS HEAVIER THAN GAS, SO BUBBLES ALWAYS TEND TO RISE). AVID'S BLEEDING PROCEDURE ALLOWS THE ISOLATION OF THE CALIPER SO IT CAN BE BLED COMPLETELY AIR FREE. THEN, BY PUSHING FLUID FROM THE CALIPER UP TO THE LEVER, YOU REMOVE ANY AIR IN THE HYDRAULIC LINE. FROM THERE, IT'S JUST A MATTER OF PURGING THOSE BUBBLES OUT OF THE RESERVOIR.

1



2



3



4



### PREPARE THE SYRINGES

1. Fill one syringe  $\frac{1}{2}$  full with Avid Hi-Performance DOT fluid and close the hose clamp. Leave the other syringe empty and open.
2. De-gas the fluid in the  $\frac{1}{2}$  full syringe (getting all the air out of the fluid now gives you the ultimate brake bleed). To do this, leave the hose clamp closed and pull down on the plunger. You will see bubbles appear from nowhere in the fluid. That is all the air trapped in the fluid. Pull on the plunger several times. When the bubble stop forming open the clamp and carefully push the excess air and gas out. Try tapping the syringe as you pull, to release more bubbles. Repeat several times.

**NOTE: BE CAREFUL NOT TO PULL TOO HARD OR YOU WILL PULL AIR PAST THE SEAL OF THE SYRINGE. YOU CANNOT ELIMINATE ALL OF THE BUBBLES IN THE FLUID. AFTER YOU HAVE PULLED A FEW TIMES AND THE NUMBER OF BUBBLES DECREASES, YOU ARE READY TO MOVE ONTO STEP 3.**

### PREPARE THE CALIPER AND THE LEVER

3. Use the T-10 Torx wrench to remove the caliper bleed port screw from the center of the banjo bolt.
 

**NOTE: THE CODE CALIPER FEATURES TWO BLEED SCREWS ON EITHER SIDE OF THE BANJO FITTING. IT IS RECOMMENDED THAT YOU USE THE BLEED PORT ON THE LEFT SIDE OF THE BANJO FITTING DURING NORMAL BLEEDING.**
4. Make sure the fluid in the  $\frac{1}{2}$  full syringe is pushed all the way to the tip (no air gap), then screw the syringe into the caliper bleed port.
 

**IMPORTANT: ENSURE THE REACH ADJUSTER IS NOT ADJUSTED SO FAR OUT THAT THE LEVER BLADE IS BOTTOMED OUT ON THE LEVER BODY. DOING SO CAN MAKE BLEEDING THE BRAKE IMPOSSIBLE.**
5. For models with Pad Contact-Point Adjustment, turn it all the way to the out position (not pictured).

**NOTE: THIS DOES NOT APPLY TO JUICY THREE OR FIVE, AS THEY DO NOT HAVE THIS FEATURE.**

## BLEEDING PROCEDURE (CONT)

6. Using a 4mm hex wrench, slightly loosen the lever clamp bolt(s) then rotate the lever so the body of the lever points straight down (perpendicular to the floor). You will need to loosen your shifter to allow the brake lever down to this position (not pictured).
7. Remove the bleed port screw and install the empty syringe, leaving the clamp on the syringe open.
8. Squeeze the lever closed (against the bar) and fasten it with a rubber band. This closes off the master cylinder and isolates the caliper, allowing the removal of any air from the caliper only before moving on to the rest of the system.

7



8



8



### BLEED THE CALIPER

9. Open the caliper syringe clamp (not pictured).
10. Gently push the syringe plunger out with your thumb. If there is air in the caliper, this draws it back into the syringe. Release the plunger to replace the bubbles you just removed with fluid. Tapping on the caliper with a non-marring instrument while performing this process helps bubbles move out into the syringe. Repeat the process until no more bubbles are drawn from the caliper. Once this is accomplished, closed the caliper syringe clamp.

**NOTE: BE CAREFUL NOT TO PULL THE PLUNGER OUT TOO HARD, OR YOU WILL SUCK AIR PAST THE SEALS.**

10



12



12



13



### BLEED THE HOSE

11. Remove the rubber band to release the lever blade (not pictured).
12. While holding the caliper syringe up to prevent bubbles from floating back into the system, open the caliper syringe clamp and force fluid from the caliper syringe up to the lever syringe. Do this until the lever syringe is approximately  $\frac{1}{4}$  full.
13. Close the lever syringe clamp, then the caliper syringe clamp. At this point, you are done at the caliper end. Remove the caliper syringe and re-install the bleed port screw. Have a paper towel ready to catch any small amount of fluid that may come out of the port when removing the syringe and re-installing the screw. Once the screw is installed, wash the caliper with water to deactivate and DOT fluid.



## BLEEDING PROCEDURE (CONT)

### BLEED THE LEVER (MASTER CYLINDER AND RESERVOIR)

14. Draw a gentle vacuum on the lever syringe by pulling on the syringe plunger. This pulls air bubbles out of the reservoir. Release the plunger to replace the bubbles you just removed with fluid.
15. Tapping on the lever with a non-marring instrument while performing this process helps bubbles move out into the syringe. You should also squeeze the lever (like you are braking) a few times while bleeding. Repeat the process until no more bubbles are drawn from the lever. Once the lever is bubble free, close the syringe clamp (not pictured).
16. With the syringe still attached, rotate the lever up 90°, so that the lever body is parallel with the floor, and the bleed port (and syringe) are pointed straight up. Now, unscrew the syringe from the bleed port.
17. Place a couple drops of DOT fluid on top of the open port and replace the bleed port screw. Have a paper towel ready to wick up any fluid that may well up in the port. Once the screw is installed, wash the lever with water to deactivate and DOT fluid.
18. Rotate the lever back to riding position and re-torque as follows:  
Juicy Five/Seven/Carbon/Ultimate/CODE torque to 2.8-3.4Nm (25-30in-lb)  
Juicy Three torque to 3-5Nm (30-40in-lb)  
Rotate shifters back to riding position and re-torque to manufacturer's specifications (not pictured).

14



16



17



# DISC BRAKE PAD REPLACEMENT

## COMPLETING HYDRAULIC DISC BRAKE HOSE ADJUSTMENT & BLEEDING

You are almost ready to ride, but first it's a good idea to test your brakes by pulling on the lever extremely hard (as hard as you can imagine yourself pulling the lever while you're riding) several times. Make sure and look around the hose nut on the lever, and the banjo bolt on the caliper for any leaks. Make one last check of all the bolts and fittings.

If everything checks out, **YOU ARE READY TO RIDE!**

**IMPORTANT: EMPTY THE SYRINGES INTO A SEALED CONTAINER AND DISPOSE OF THE FLUID PROPERLY. DO NOT REUSE THIS FLUID! DO NOT LEAVE THE HOSE CLAMPS CLOSED (THIS WILL DAMAGE THE CLEAR TUBING ON THE SYRINGES)!**



# DISC BRAKE PAD REPLACEMENT

(JUICY 3, 5, 7, CARBON, ULTIMATE)

## INTRODUCTION

Avid brake pads should be replaced when the total thickness of the backing plate and pad friction material is less than 3mm. Replacing worn brake pads will improve braking performance. New brake pads are subject to a “break-in” period. It may take anywhere from 20 to 40 complete stops to break in Avid pads. You may begin to notice an increase in braking power after the first ride. Brake noise can occur during the break-in period, as well as off and on throughout the life of the brake pads. This is normal and should not affect braking performance. Noise is dependent upon factors such as brake setup, rider weight, riding style, braking style, and riding conditions (i.e. dust, soil, and contamination of friction surfaces).

## PAD REPLACEMENT

### PUSH THE PISTONS BACK IN

1. The Juicy calipers are self adjusting. Therefore, the pistons need to be pushed back into their original position in the body before the new pads can be installed. The best way to do this is with the old pads still in the caliper to protect the pistons. Place a flat-blade screwdriver between the old pads and gently rock it back and forth, pushing the pistons back into their bores (not pictured).

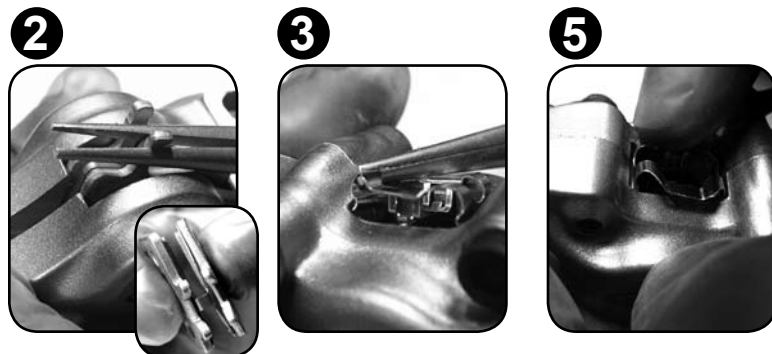

### REMOVE THE OLD PADS AND H-SPRING

2. Using needle-nosed pliers, grab one of the pad tabs and slide the pad toward the center of the caliper (this disengages the pad backing plate from the post in the center of the piston), then pull the pad straight out. Repeat for other pad.



**NOTE: IF THE H-SPRING DOESN'T COME OUT WITH THE SECOND PAD, PUSH IT OUT FROM THE OPEN TOP OF THE CALIPER WITH A PICK OR YOUR FINGER.**

3. Remove the spring pad clip from the outside of the caliper.
4. Inspect and measure the total thickness of each brake pad with a ruler. If the total thickness is less than 3mm, you need to replace both brake pads (not pictured).

**NOTE: IF THE BACKING PLATE AND PAD MATERIAL IS THICKER THAN 3MM, YOU CAN SIMPLY RE-INSTALL YOUR BRAKE PADS AS OUTLINED IN STEP 5.**

### INSTALL THE NEW PADS AND H-SPRING

5. Position the h-spring between the two pads. The curved handle of inner pad should face toward the inboard side of the caliper. Squeeze the pad and spring assembly together, then firmly push into the caliper until it ‘clicks’ into place, indicating it is properly secured in the caliper body.

**THIS CONCLUDES THE DISC BRAKE PAD REPLACEMENT INSTRUCTIONS. YOU DID A GREAT JOB! YOU ARE NOW READY TO RIDE. ENJOY!**

# DISC BRAKE PAD REPLACEMENT

(CODE)

## INTRODUCTION

Avid brake pads should be replaced when the total thickness of the backing plate and pad friction material is less than 3mm. Replacing worn brake pads will improve braking performance. New brake pads are subject to a “break-in” period. It may take anywhere from 20 to 40 complete stops to break in Avid pads. You may begin to notice an increase in braking power after the first ride. Brake noise can occur during the break-in period, as well as off and on throughout the life of the brake pads. This is normal and should not affect braking performance. Noise is dependent upon factors such as brake setup, rider weight, riding style, braking style, and riding conditions (i.e. dust, soil, and contamination of friction surfaces).

## PAD REPLACEMENT

### REMOVE OLD BRAKE PADS AND H-SPRING

1. Remove e-clip from guide pin groove on top of the caliper using a sharp pick.
2. Using a 2.5mm hex wrench remove the guide pin from the caliper.
3. Squeeze the pads together so they clear the piston, and pull to remove brake pads and h-spring from caliper.
4. Inspect and measure the total thickness of each brake pad with a ruler or the pad thickness slot on the pad spacer tool. If the total thickness is less than 3mm, or it fits into the slot, you need to replace both brake pads (not pictured).

**NOTE: IF THE BACKING PLATE AND PAD MATERIAL IS THICKER THAN 3MM OR THE SLOT, YOU CAN SIMPLY RE-INSTALL YOUR BRAKE PADS AS OUTLINED IN STEPS 5-10.**

### INSTALL THE NEW PADS AND H-SPRING

5. Position the h-spring between the two pads. **NOTE: THE CODE PADS ARE SYMMETRICAL, THERE IS NOT A LEFT OR RIGHT ORIENTATION.**
6. Locate the pad installation feature of the pad spacer tool. Insert the pad handles into the pad installation tool so it holds the pads together.
7. Insert the pads and pad tool into the caliper until the holes in the top of the pads are aligned with the guide pin holes in the top of the caliper.
8. Insert the guide pin through the caliper body halves and the brake pads. Using a 2.5mm hex wrench, tighten the guide pin to 1.5-1.9Nm (13-17 in-lb).
9. Remove the pad tool. The h-spring will snap the pads into position.
10. Using your thumb or finger, install the e-clip into the groove on the end of the guide pin.

**THIS CONCLUDES THE DISC BRAKE PAD REPLACEMENT INSTRUCTIONS. YOU DID A GREAT JOB! YOU ARE NOW READY TO RIDE. ENJOY!**

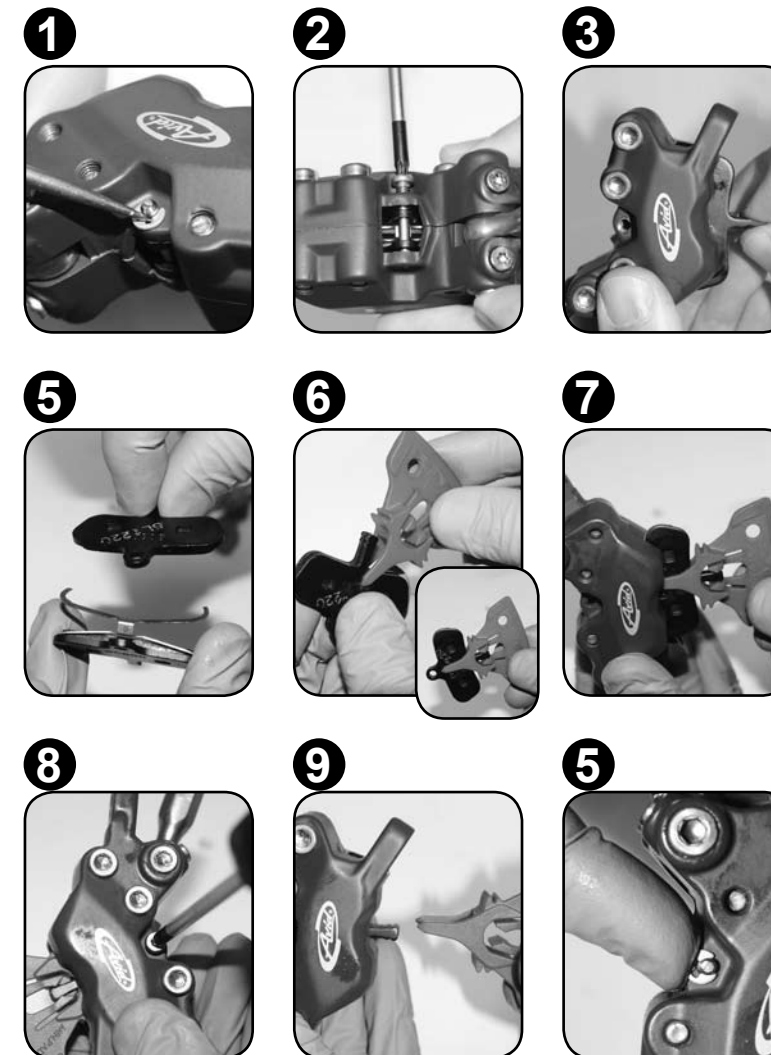



# DISC BRAKE PAD REPLACEMENT (BB7)

## INTRODUCTION

Avid brake pads should be replaced when the total thickness of the backing plate and pad friction material is less than 3mm. Replacing worn brake pads will improve braking performance. New brake pads are subject to a “break-in” period. It may take anywhere from 20 to 40 complete stops to break in Avid pads. You may begin to notice an increase in braking power after the first ride. Brake noise can occur during the break-in period, as well as off and on throughout the life of the brake pads. This is normal and should not affect braking performance. Noise is dependent upon factors such as brake setup, rider weight, riding style, braking style, and riding conditions (i.e. dust, soil, and contamination of friction surfaces).

## PAD REPLACEMENT

### REMOVE THE OLD PADS

1. Turn both adjuster knobs all the way out (counterclockwise), then squeeze the pad tabs together and pull both pads and pad spring clip straight out of the caliper.
2. Inspect and measure the total thickness of each brake pad with a ruler. If the total thickness is less than 3mm, you need to replace both brake pads (not pictured).

**NOTE: IF THE BACKING PLATE AND PAD MATERIAL IS THICKER THAN 3MM, YOU CAN SIMPLY RE-INSTALL YOUR BRAKE PADS AS OUTLINED IN STEP 3 AND FOLLOW THE PROCEDURES FOR PAD WEAR ADJUSTMENT.**

1



3

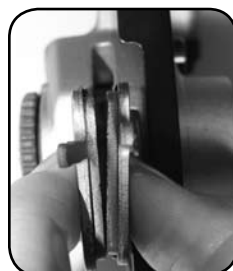

### INSTALL THE NEW PADS AND SPRING

3. Assemble the spring between the new left and right pads. Align the spring to the pad as shown. Squeeze the brake pad and spring clip assembly together then press firmly into the caliper until it “clicks” into place. The pad marked “R” goes on the spoke side of the brake.

### PAD WEAR ADJUSTMENT (NOT PICTURED)

The BB7 has a manual pad wear adjustment feature. You can use this feature to compensate for brake pad wear until the pads need to be replaced with two very simple adjustments: Turn both the inboard and outboard red adjusting knobs clockwise one or two clicks as needed to restore your brake to optimum settings. Do NOT use your barrel adjuster to compensate for pad wear. A pad wear indicator is at the center of each knob. As the knob is turned in, the indicator will retract deeper into the knob giving a visual indication of approximately how much the pads have worn.

**THIS CONCLUDES THE DISC BRAKE PAD REPLACEMENT INSTRUCTIONS. YOU HAVE DONE A GREAT JOB! YOU ARE NOW READY TO RIDE. ENJOY!**



[www.sram.com](http://www.sram.com)  
[www.avidbike.com](http://www.avidbike.com)

**WORLD HEADQUARTERS**  
**SRAM Corporation**  
**1333 N. Kingsbury St., 4th Floor**  
**Chicago, IL 60622**  
**phone: +1-312-664-8800**  
**fax: +1-312-664-8826**

**EUROPEAN HEADQUARTERS**  
**SRAM Europe**  
**Basicweg 12-D**  
**3821 BR Amersfoort**  
**The Netherlands**  
**phone: +31-33-450-6060**  
**fax: +31-33-457-0200**

**ASIAN HEADQUARTERS**  
**SRAM Taiwan**  
**No. 1598-8 Chung Shan Rd**  
**Shen Kang Hsiang, Taichng**  
**County 49**  
**Taiwan R.O.C.**  
**phone: +886-4-2561-3678**  
**fax: +886-4-2561-3686**



 **POWERED BY SRAM™**